



TAOGLAS®



Datasheet

Part No: FXP612.07.0095A

Description:

FXP612 Flexible Polymer
GPS L1 / GPS L2 / GPS L5 / GALILEO /
GLONASS G1 / BEIDOU Antenna

Features:

GPS L1 / GALILEO :1563-1587 MHz
GPS L2 :1215-1240 MHz
GPS L5 :1164-1189 MHz
GLONASS G1: 1593-1610 MHz
BEIDOU:1559-1591 MHz
Flexible Loop Antenna
3 dBi Peak Gain-90% Efficiency
Peel and Stick
Dims: 76mm*47mm*0.15mm
Cable Length : 95mm
IPEX MHFI Connector (U.FL compatible)
Patent Pending
RoHS compliant



1. Introduction	3
2. Specifications	4
3. Antenna Characteristics	6
4. Radiation Patterns	9
5. Mechanical Drawing	14
6. Packaging	15
<hr/>	
7. Application Note	16
<hr/>	
Changelog	17

Taoglas makes no warranties based on the accuracy or completeness of the contents of this document and reserves the right to make changes to specifications and product descriptions at any time without notice. Taoglas reserves all rights to this document and the information contained herein. Reproduction, use or disclosure to third parties without express permission is strictly prohibited.



1. Introduction



The patent pending FXP612 embedded flexible antenna is a next generation GNSS antenna designed to cover working frequencies in the GPS L1/L2/L5/ GLONASS / GALILEO / BeiDou bands. This antenna features the highest efficiencies in the market, not just an incredible efficiency of 90% in GPS/GALILEO/GLONASS/BeiDou L1 bands, but also 70% efficiency in the GPS L2 and L5 bands. The FXP612 is a linear polarized antenna, but with an omnidirectional radiation pattern which makes it less sensitive to device orientation. The VSWR is also extremely low, below 1.6 at all bands, this of course contributes to it's total radiation efficiency, but also means it is ideal for low power consumption applications.

This antenna is made of durable, flexible, polymer with a cable and connector for easy installation. It is designed to be mounted directly to the inner shell of a plastic housing or glass enclosure/cover. No space is needed on the PCBs of your device, but at least 20mm of minimum clearance is required from the ground-plane to achieve optimal antenna efficiency. At 76mm*47mm*0.15mm, the antenna is ultrathin and can be applied by a simple peel and stick process, attaching securely to non-metal surfaces via 3M adhesive. It has been tuned to work directly on ABS/PC plastic housings.

Typical Applications

- Telematics
- Fleet Management
- Positioning

It is an ideal choice for any device maker that needs a solution that can work on L1 and L2 today, but also for years to come with the new L2 and L5 GPS civilian signal bands coming on stream in 2020 and beyond, and which would like to keep manufacturing costs down over the lifetime of a product. Cable type, length and connectors are customizable. For cable lengths over 200mm, it is recommended to use an active GPS/GALILEO patch antenna. Please contact your regional Taoglas sales office for support.

2. Specifications

GNSS Frequency Bands Covered						
GPS	L1	L2	L5			
	■	■	■			
GLONASS	G1	G2	G3			
	■	■	■			
Galileo	E1	E5a	E5b	E6		
	■	■	■	□		
BeiDou	B1	B2a	B2b	B3		
	■	■	■	■		
QZSS (Regional)	L1	L2C	L5	L6		
	■	■	■	□		
IRNSS (Regional)	L5					
	■					
SBAS	L1/E1/B1	L5/B2a/E5a	G1	G2	G3	
	■	■	■	■	■	

*SBAS systems: WASS(L1/L5), EGNOS(E1/E5a), SDCM(G1/G2/G3), SNAS(B1,B2a), GAGAN(L1/L5), QZSS(L1/L5), KAZZ(L1/L5).

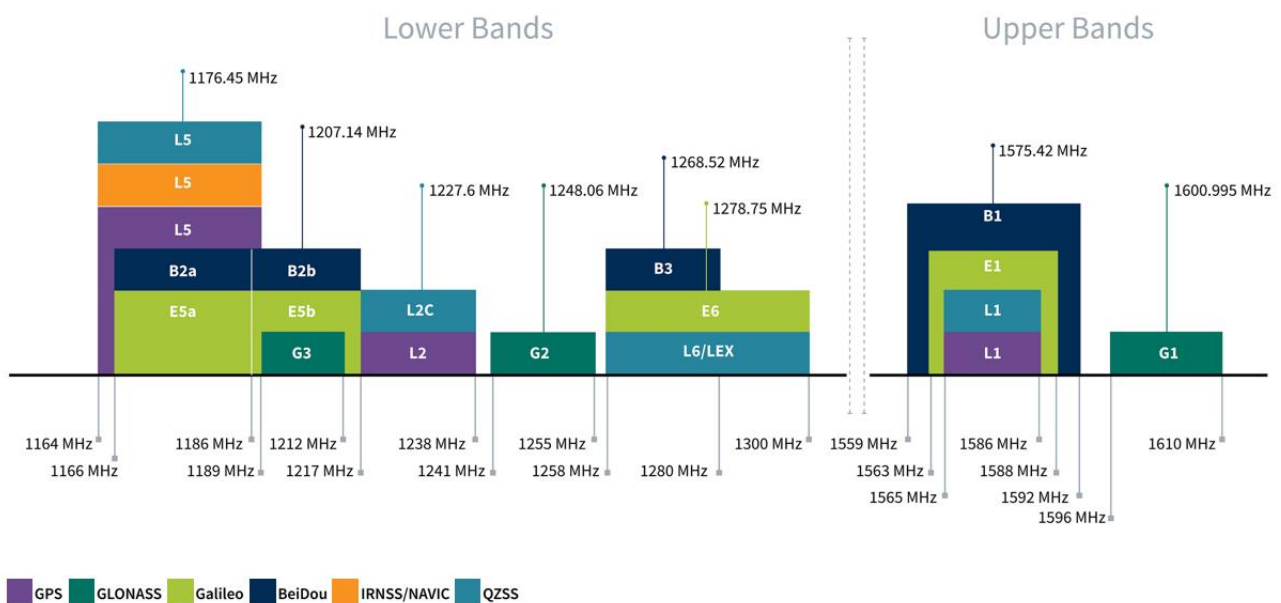

Electrical									
Band	Frequency (MHz)	Return Loss	Efficiency (%)	Peak Gain (dBi)	VSWR	Impedance	Max Power Input	Polarization	Radiation Pattern
GPS L1 /GALILEO	1563~1587	-16.2	91	3.7	1.2	50Ω	5W	Linear	Omnidirectional
GPS L2	1215~1240	-12.6	73	3.3	1.6				
GPS L5	1164~1189	-16.0	70	3.1	1.3				
GLONASS	1593~1610	-20.4	92	3.9	1.1				
BEIDOU	1559~1591	-23.0	91.5	4.0	1.2				

Mechanical	
Dimensions	76*47*40.15 mm
Material	FPCB
Cable	Mini-Coax 1.13 mm, Cable Length: 95mm
Connector	MHFI (U.FL compatible)
Weight	3g
Environmental	
Temperature Range	-40°C to 85°C
Storage Temperature	-40°C to 105°C
Humidity	Non-condensing 65°C 95% RH

* The FXP612 antenna performance was measured with 30X30 cm ABS Plastic (2mm thickness)

3. Antenna Characteristics

3.1 Set Up

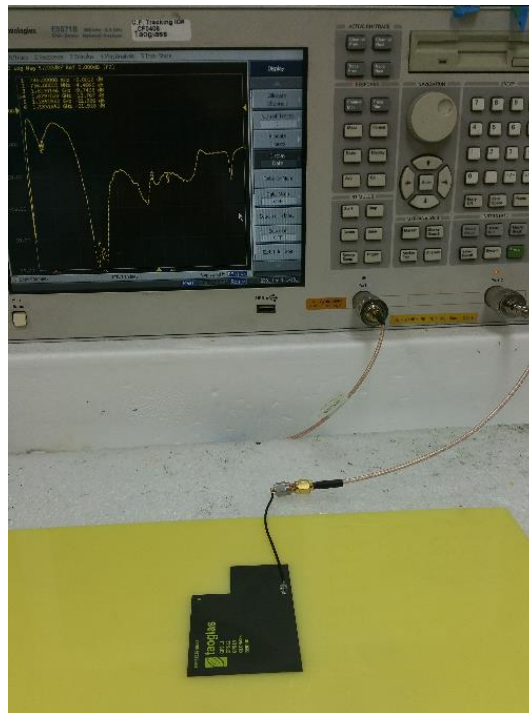

3.2 Return Loss

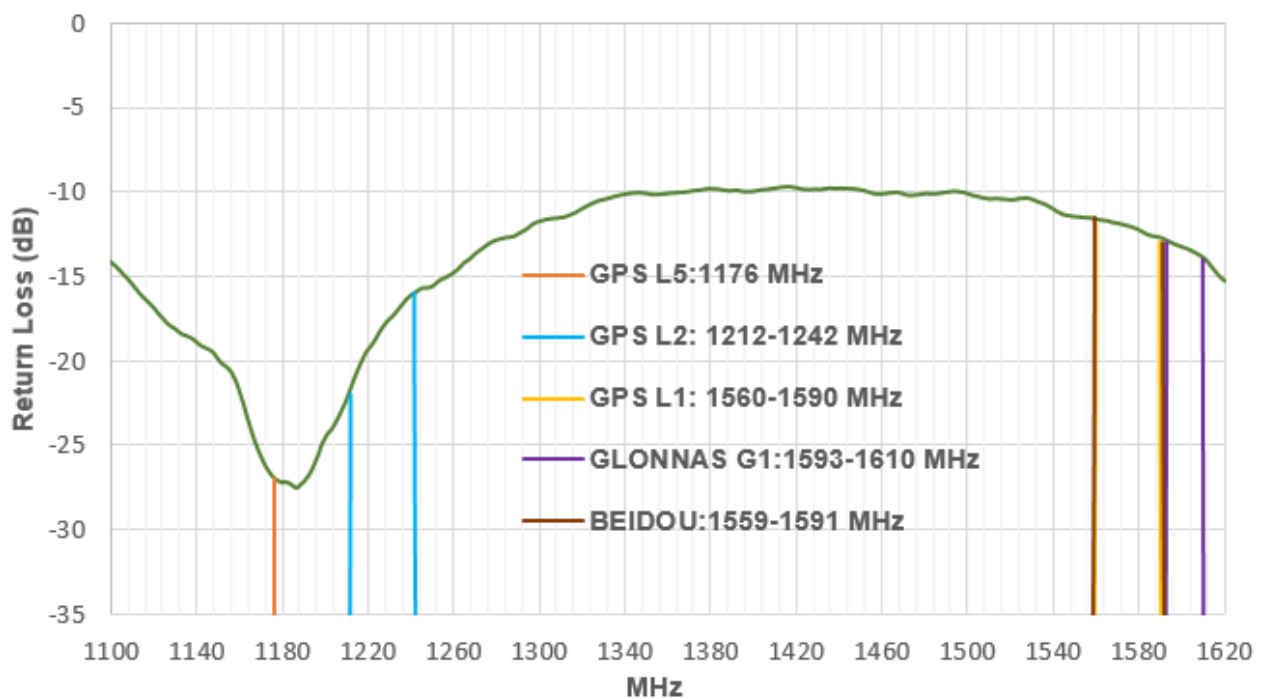

3.3 VSWR

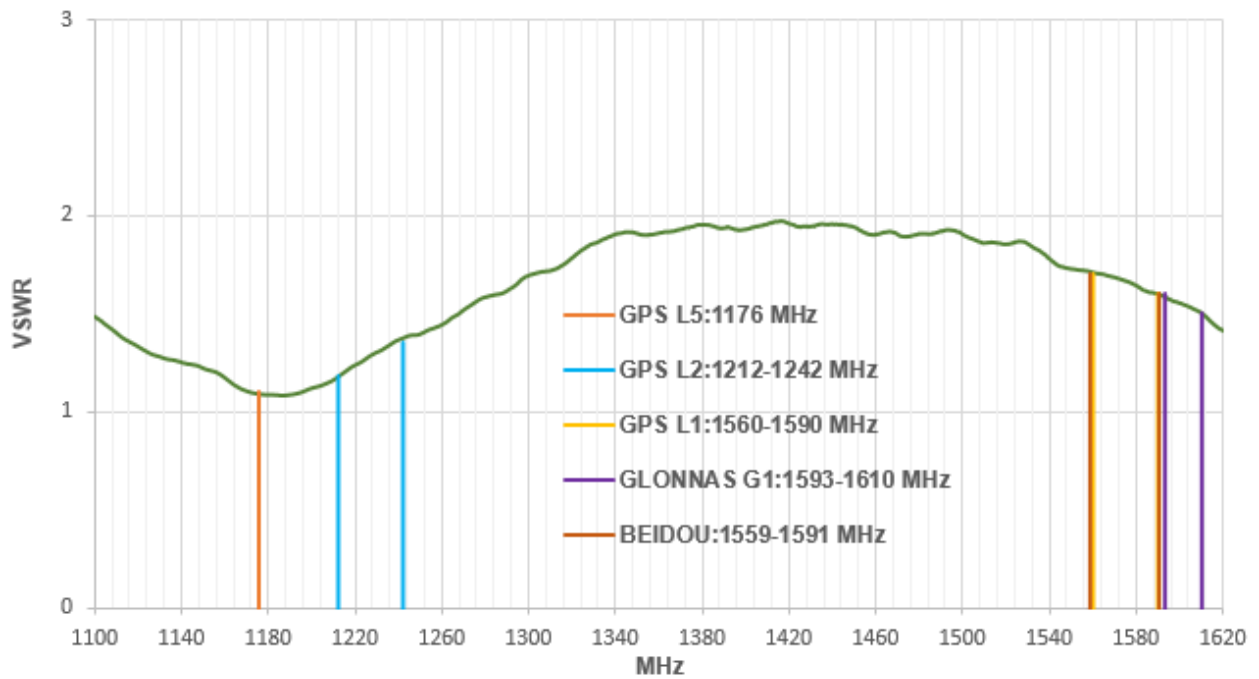

3.4 Efficiency

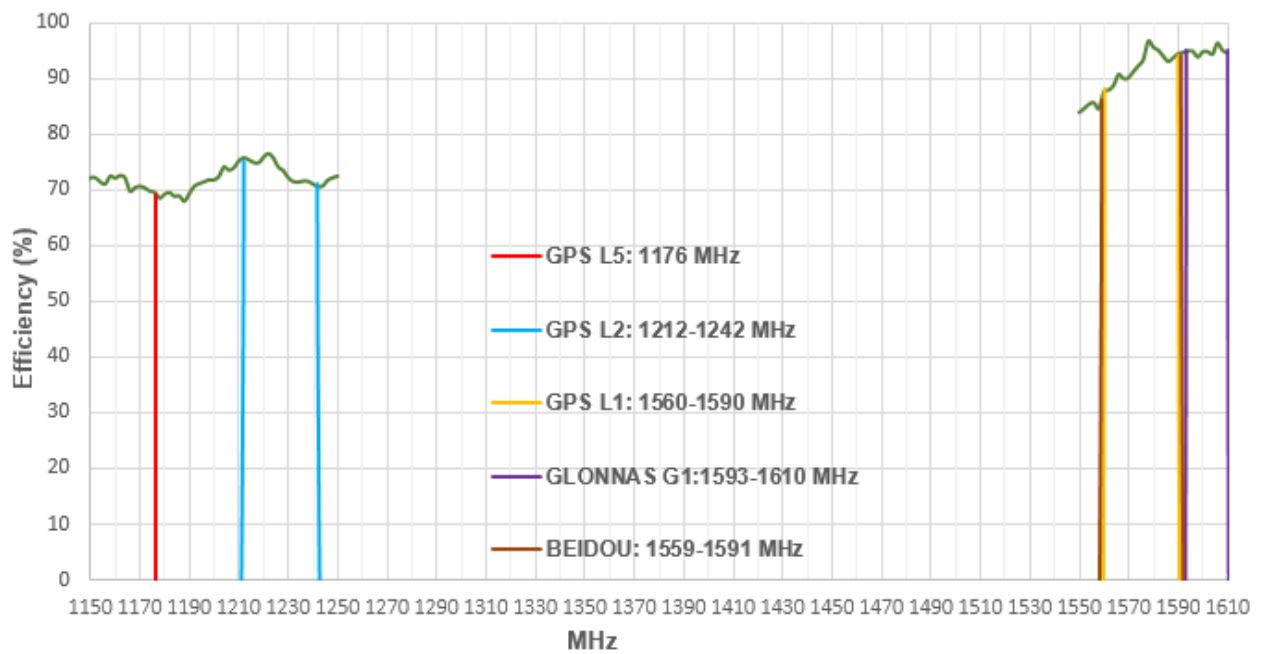

3.5 Peak Gain

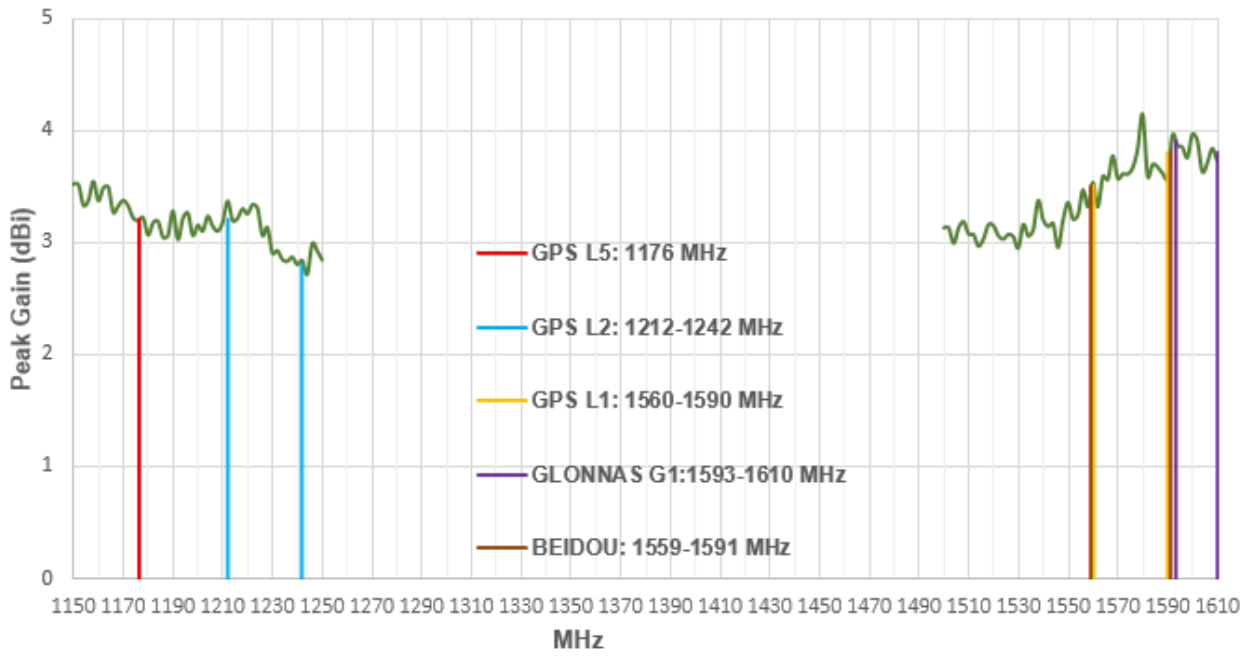

4. Radiation Patterns

4.1 Test Setup



4.2 2D Radiations Patterns

4.2.1 XY Plane

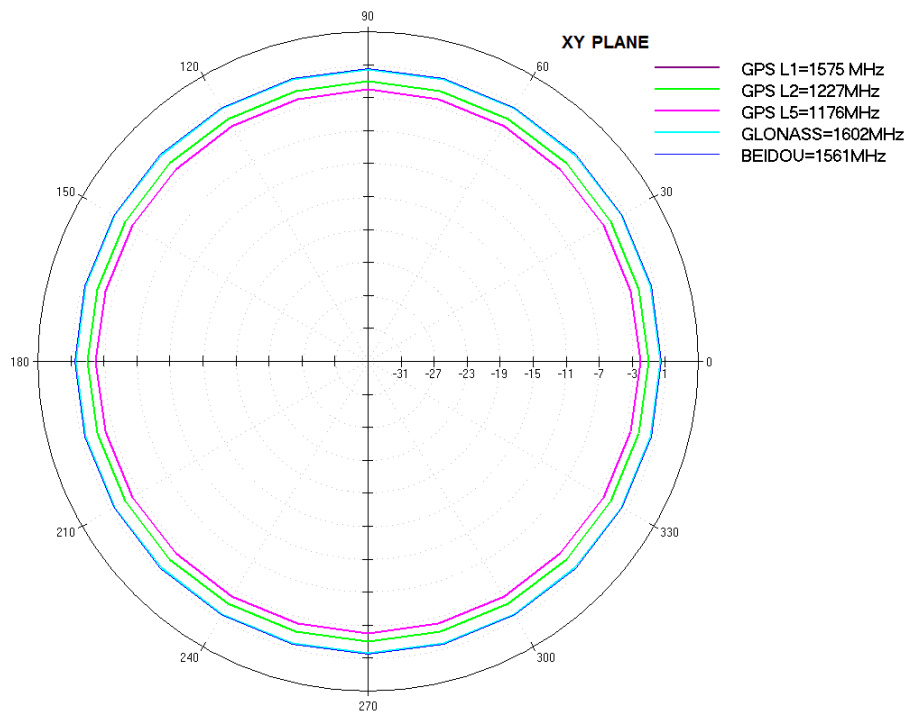

4.2.2 ZY Plane

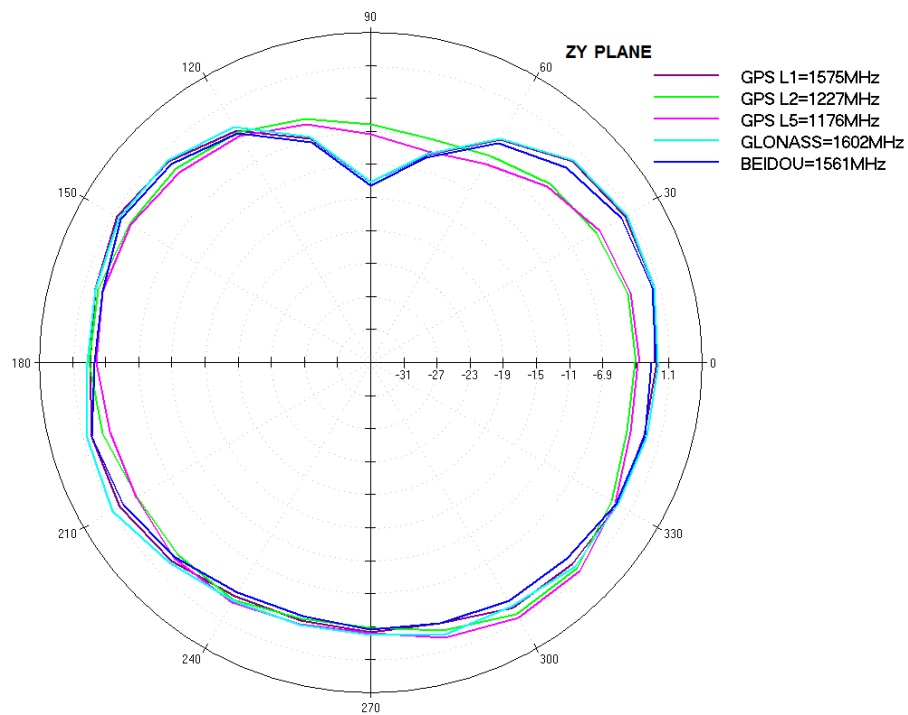

4.3 3D Radiation Pattern

4.3.1 GPS L1/GALILEO at 1575 MHz

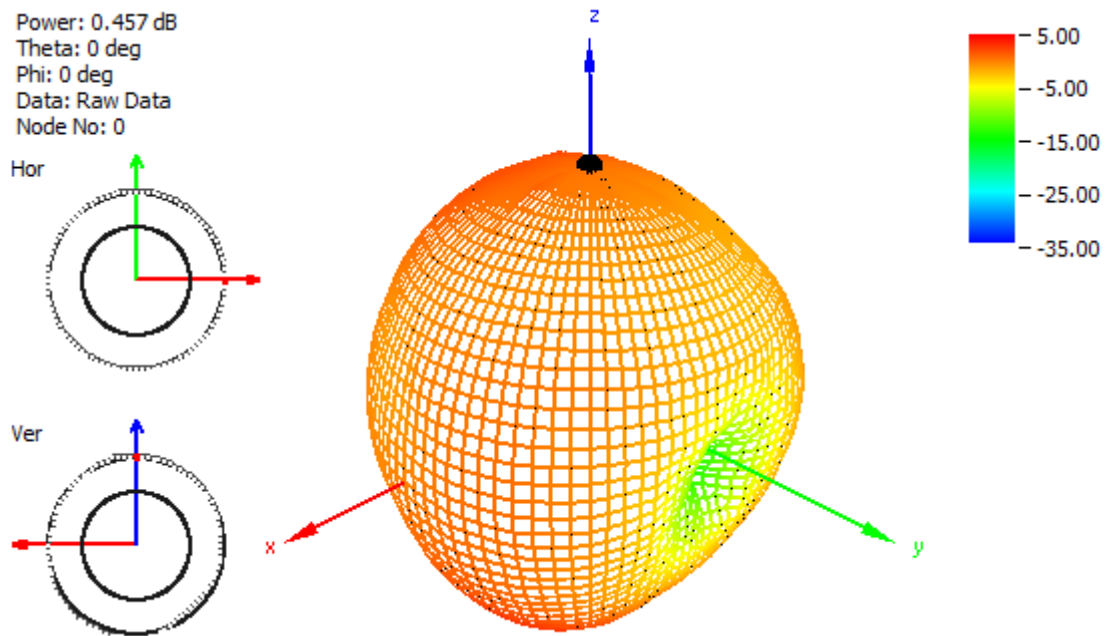

4.3.2 GPS L2 at 1227 MHz

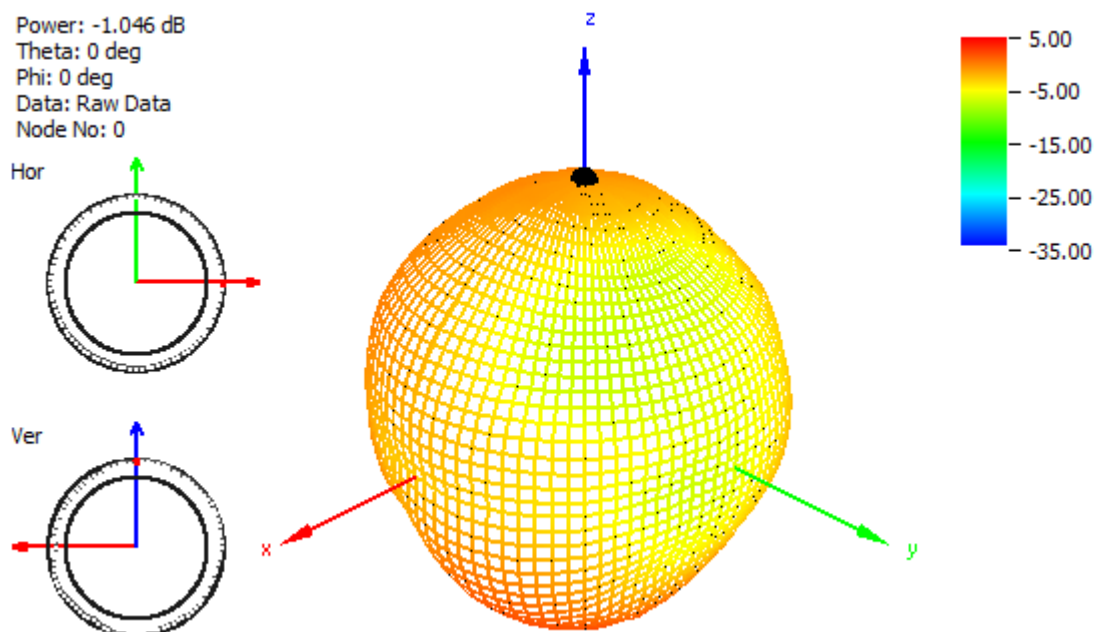

4.3 3D Radiation Pattern

4.3.3 GPS L5 at 1176 MHz

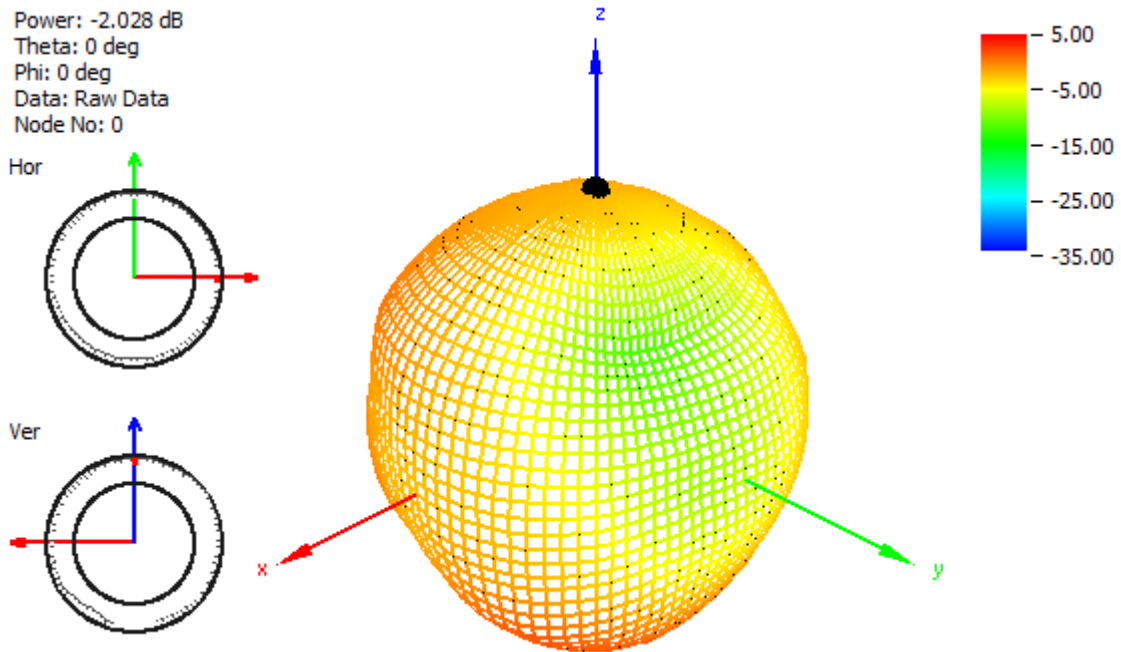

4.3.4 GLONASS at 1602 MHz

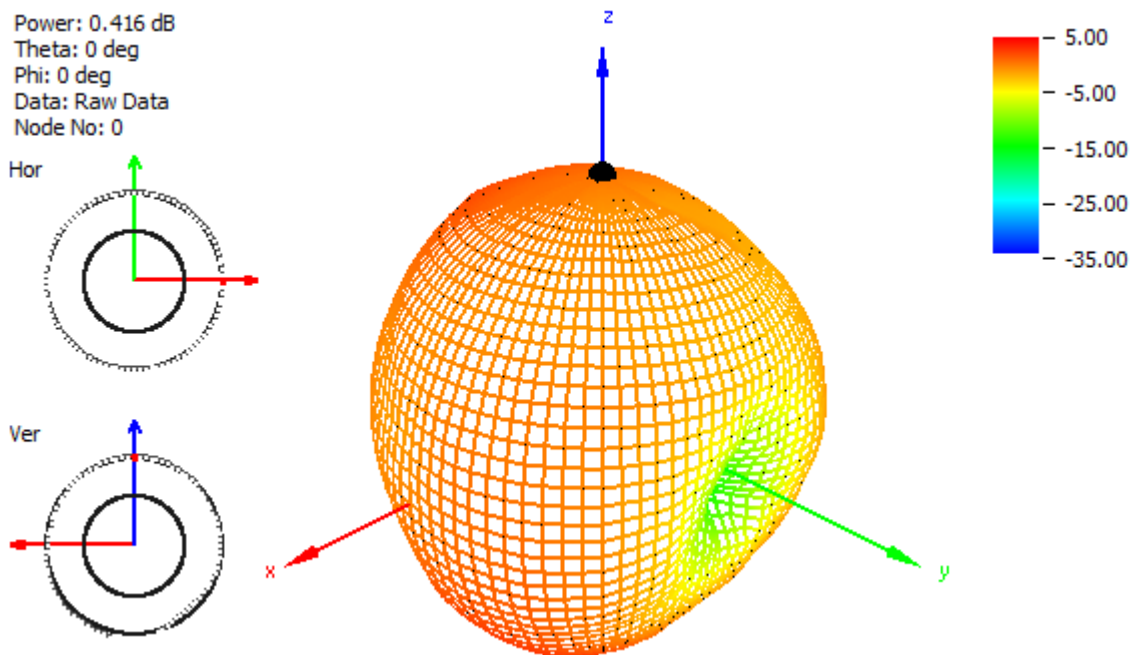

4.3 3D Radiation Pattern

4.3.5 BEIDOU at 1561 MHz

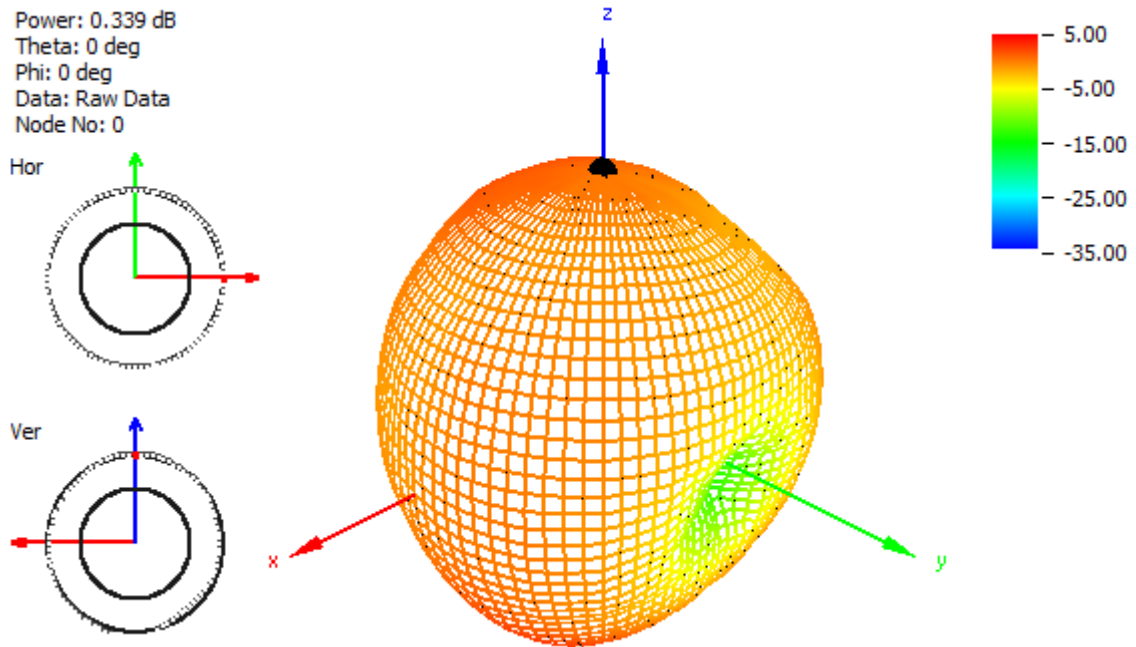

5. Mechanical Drawing (Units: mm)

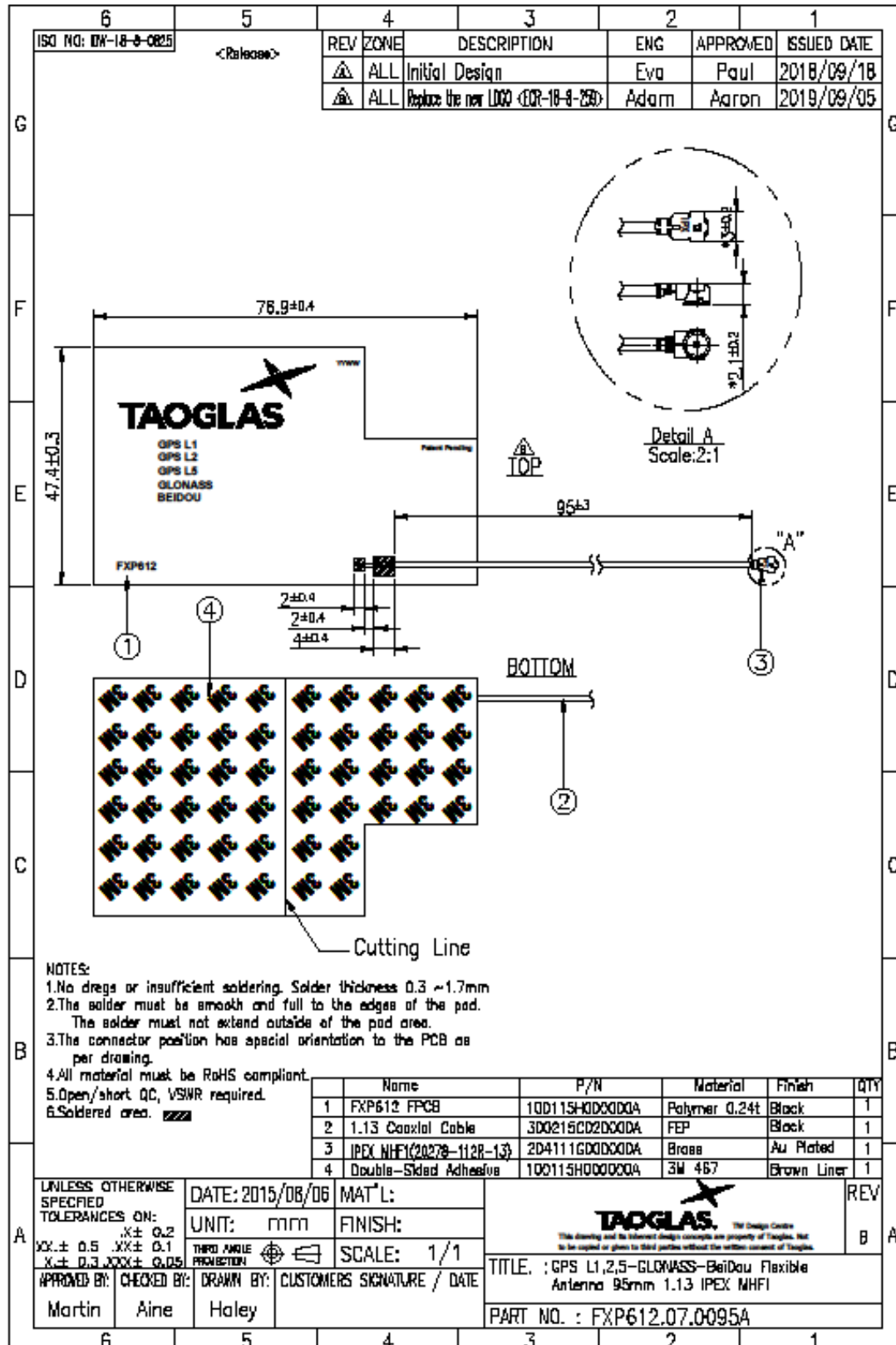

6. Packaging

FXP612.07.0095A

Packaging Specifications

100pcs FXP612.07.0095A per PE Bag
 Bag Dimensions - 270 x 180mm
 Weight - 207g

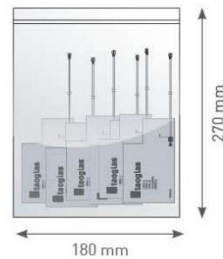

1000pcs FXP612.07.0095A per PE Large Bag
 Bag Dimensions - 466 x 380mm
 Weight - 2.1kg

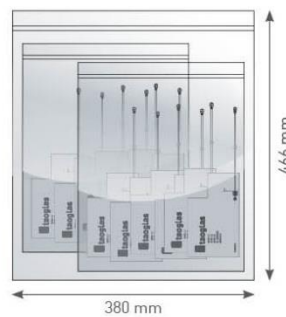

5,000 pcs FXP612.07.0095A per carton
 Carton - 320 x 250 x 230mm
 Weight - 10.5Kg

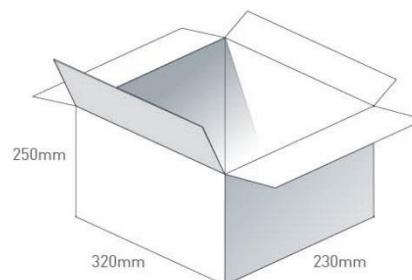

Pallet Dimensions 960 x 1000 x 1300mm
 60 Cartons per Pallet
 12 Cartons per layer
 5 Layers

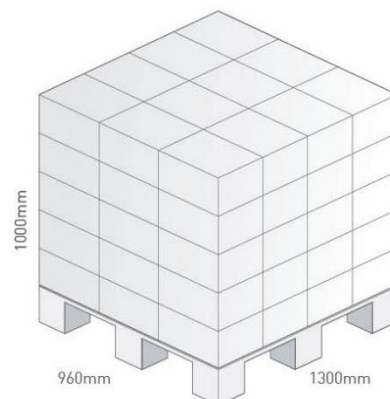

7. Application Note

The FXP612 antenna performance with different cable lengths.

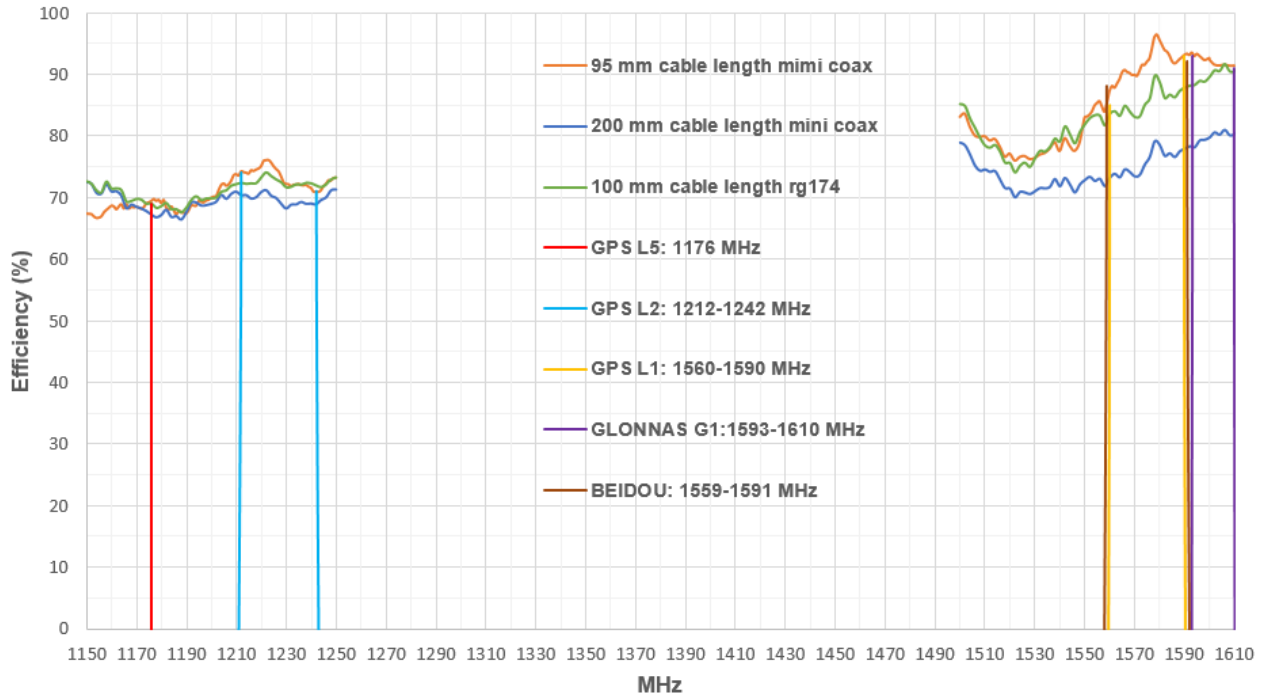

Taoglas makes no warranties based on the accuracy or completeness of the contents of this document and reserves the right to make changes to specifications and product descriptions at any time without notice. Taoglas reserves all rights to this document and the information contained herein.

Reproduction, use or disclosure to third parties without express permission is strictly prohibited.

Copyright © Taoglas Ltd.

Changelog for the datasheet

SPE-16-08-027 – FXP612.07.0095A

Revision: B (Current Version)	
Date:	2022-06-07
Changes:	Updated Image and Drawing
Changes Made by:	Cesar Sousa

Previous Revisions

Revision: A (Original First Release)	
Date:	2016-04-13
Notes:	4/13/2016
Author:	



www.taoglas.com

