



Model Number

UC3500-30GM70S-IE2R2-V15

Ultrasonic diffuse sensor with pivoting transducer

Features

- Analog output 4 ... 20 mA
- 1 switch output
- Synchronization options
- Temperature compensation
- Can be parameterized via the ULTRA-PROG-IR software and interface (accessories)

Diagrams

Characteristic response curve

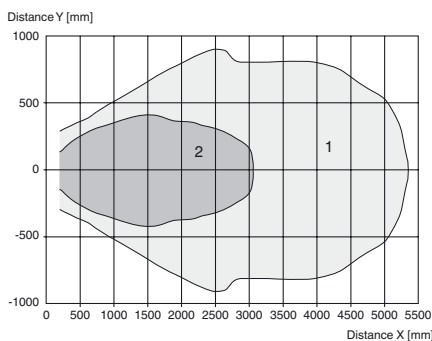

Curve 1: flat surface 100 mm x 100 mm
Curve 2: round bar, Ø 25 mm

Release date: 2012-05-14 11:22 Date of issue: 2013-10-25 236397_eng.xml

Technical data

General specifications

Sensing range	200 ... 3500 mm
Adjustment range	300 ... 3500 mm
Unusable area	0 ... 200 mm
Standard target plate	100 mm x 100 mm
Transducer frequency	approx. 120 kHz
Response delay	≤ 150 ms

Nominal ratings

Temperature drift	≤ ± 1.5 % of full-scale value
Time delay before availability t_v	≤ 175 ms

Limit data

Permissible cable length	max. 300 m
--------------------------	------------

Indicators/operating means

LED yellow	switching state switch output
LED green/yellow	yellow: object in evaluation range green: Teach-In
Potentiometer	switch output adjustable

Electrical specifications

Rated operating voltage U_o	24 V DC
Operating voltage U_B	20 ... 30 V DC (including ripple)
Ripple	≤ 10 %
No-load supply current I_o	≤ 50 mA

Interface

Interface type	Infrared
Mode	point-to-point connection

Input/Output

Input/output type	1 synchronization connection, bidirectional (Factory setting: synchronized mode) / Teach-In input
0 Level	≤ 3 V
1 Level	≥ 15 V
Input impedance	typ. 900 Ω
Number of sensors	max. 10

Switching output

Output type	1 switch output PNP, NO (NC contact programmable)
Default setting	300 ... 3500 mm (adjustable via potentiometer)
Repeat accuracy	± 5 mm
Operating current I_L	300 mA , short-circuit/overload protected
Switching frequency	≤ 2 Hz
Switching hysteresis	35 mm (programmable)
Voltage drop	≤ 3 V
Off-state current	≤ 10 μA

Analog output

Output type	1 current output 4 ... 20 mA , ascending/descending programmable
Default setting	rising slope ; evaluation limit A1: 300 mm ; evaluation limit A2: 3500 mm
Load resistor	≤ 500 Ω

Ambient conditions

Ambient temperature	-25 ... 70 °C (-13 ... 158 °F)
Storage temperature	-40 ... 85 °C (-40 ... 185 °F)
Shock resistance	30 g , 11 ms period
Vibration resistance	10 ... 55 Hz , Amplitude ± 1 mm

Mechanical specifications

Connection type	Connector M12 x 1 , 5-pin
Protection degree	IP65
Material	
Housing	brass, nickel-plated
Transducer	epoxy resin/hollow glass sphere mixture; polyurethane foam
Installation position	any position
Mass	170 g
Construction type	Cylindrical

Compliance with standards and directives

Standard conformity	
Standards	EN 60947-5-2:2007 IEC 60947-5-2:2007

Approvals and certificates

UL approval	cULus Listed, General Purpose
CSA approval	cCSAus Listed, General Purpose
CCC approval	CCC approval / marking not required for products rated ≤36 V

Dimensions

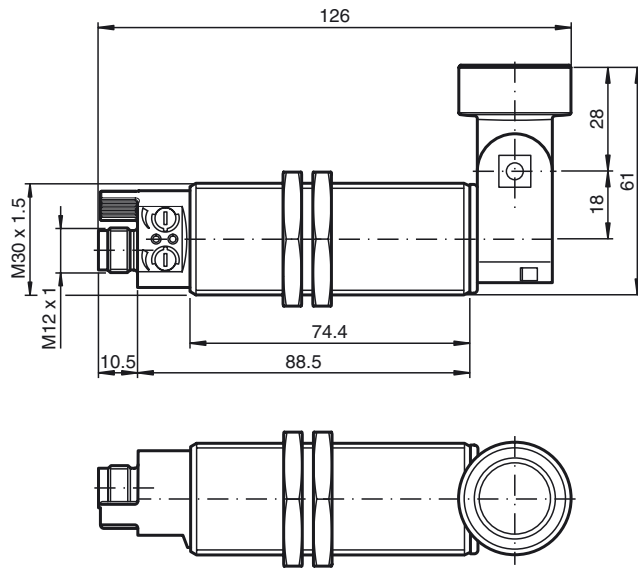

Electrical Connection

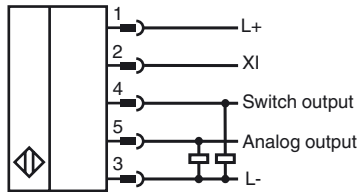

Pinout

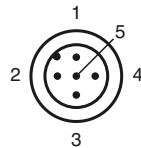

Wire colors in accordance with EN 60947-5-2

1	BN	(brown)
2	WH	(white)
3	BU	(blue)
4	BK	(black)
5	GY	(gray)

Additional Information

Analog output operating mode

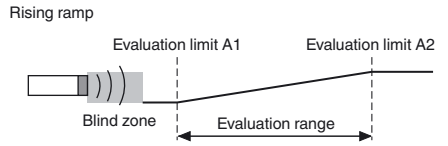

Switching output operating mode

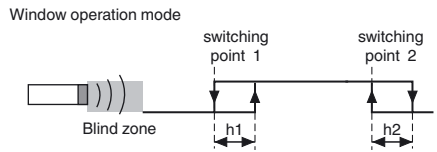

Accessories

BF 30

Mounting flange, 30 mm

BF 5-30

Universal mounting bracket for cylindrical sensors with a diameter of 5 ... 30 mm

V15-G-2M-PUR

Female cordset, M12, 5-pin, PUR cable

V15-W-2M-PUR

Female cordset, M12, 5-pin, PUR cable

UC-18/30GM-IR

Interface cable

ULTRA-PROG-IR

Configuration software for ultrasonic sensors

Description of Sensor Functions

Displays and Controls

The sensor has two potentiometers and two display LEDs.

LED 1 (yellow)	On/off: Switching state of switching output Flashing: Error when setting the switching points (switching point 2 < switching point 1). This state only occurs in window function operating mode (2 switching points).	
LED 2 (yellow)	On/off: Object between evaluation limit A1 and evaluation limit A2 in the analog evaluation range.	
LED 2 (green)	approx. 500 ms on: Range limit taught in Off: Normal mode	
Potentiometer 1	Setting for switching point 1 of the switching output.	
Potentiometer 2	Setting for switching point 2 of the switching output	

The potentiometer function described illustrates the default function. The function of the potentiometer can be altered using the ULTRA-PROG-IR software. As soon as a configuration has been changed, the potentiometer function selected using ULTRA-PROG-IR is activated.

Setting the Sensor Using the Potentiometers

The sensor is equipped with two potentiometers. These potentiometers are assigned to the switching output by default. The switching output operates in window mode by default (2 switching points). Potentiometer 1 is used to set the near switching point of the switching window. Potentiometer 2 is used to set the distant switching point of the switching window.

Note:

The function of the potentiometer can be altered using the ULTRA-PROG-IR software. As soon as a configuration has been changed, the potentiometer function selected using ULTRA-PROG-IR is activated.

Parameterization via ULTRA-PROG-IR

In order to be able to set the sensor parameters and adjust the sensor to the respective application, the sensor is able to communicate with a PC via the integrated infrared interface. The UC-18/30GM-IR interface cable is required to allow communication via this method. This cable is connected to an unused USB port on the PC.

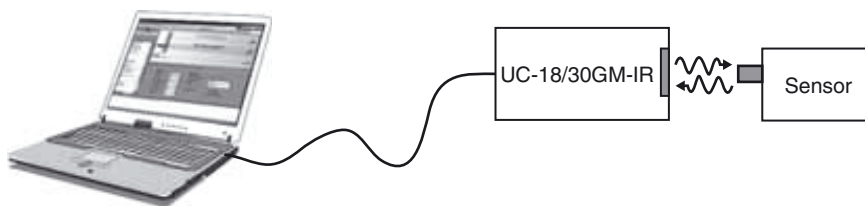

The ULTRA-PROG-IR parameterization software is also required for setting the sensor parameters. The ULTRA-PROG-IR software can be downloaded for free from the www.pepperl-fuchs.com website. The software allows all open parameters to be set, including:

- All trip points and switching hystereses
- Output modes and behaviors
- Delay times
- Settings and setting ranges of the potentiometer
- Settings for teach-in and synchronization
- Definition of blind zones
- Sensor modes and measurement methods
- Filtering measurement values

The following service functions are also available:

- Observing and recording measurement values
- Diagnosing interference reflections

Teach-in

The sensor is equipped with a function input (XI). In order to teach in a limit value, this sensor must be parameterized as the Teach-in input using the ULTRA-PROG-IR parameterization software. This parameterization software allows you to specify what limit value is taught in.

Release date: 2012-05-14 11:22 Date of issue: 2013-10-25 236397_eng.xml

Note:

The Teach-in function is not activated when the sensor is delivered.

Description of the Teach-in process:

1. Position an object at the required distance.
2. Connect the Teach-in input to L-.
The green LED lights up briefly after approx. 3 seconds. This indicates that the required distance has been successfully saved.
3. Disconnect the Teach-in input from L-.

Note:

If the Teach-in input remains connected to L-, the Teach-in process is repeated every 3 seconds.

Synchronization

The sensor features a function input (XI). Using the ULTRA-PROG-IR parameterization software, this function input can be configured as a synchronization input to suppress mutual interference from external ultrasonic signals. This is illustrated in the following description.

If the synchronization input is not connected, the sensor operates with internally generated cycle pulses.

External synchronization

The sensor can be synchronized by applying external rectangular pulses. The pulse duration must be $\geq 100 \mu\text{s}$. Each rising pulse edge sends an individual ultrasonic pulse. If the signal at the synchronization input is high, the sensor reverts to the normal, unsynchronized operating mode.

If a low signal is applied to the synchronization input, the sensor switches to standby. In this operating mode, the last recorded output statuses are retained.

Internal synchronization**Common mode operation**

Up to ten sensors can be synchronized with each other. To do this, the synchronization inputs of the individual sensors are connected to each other. When configured in this state, all of the sensors send the ultrasonic signals together at the same time. The cycle rate corresponds to the cycle rate of the sensor with the lowest rate.

Multiplex mode

Up to ten sensors can work in multiplex mode; i.e. the sensors send their ultrasonic signals in succession. This prevents the sensor signals interfering with each other. In multiplex mode, the synchronization inputs of all sensors are connected to each other. An address must also be assigned to each sensor using the ULTRA-PROG-IR parameterization software, and the number of sensors to be synchronized must be determined. To start multiplex mode, all sensors are commissioned together by switching on the power supply.