

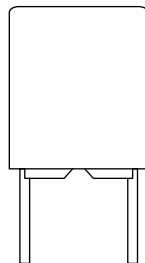

Metallized Polyester Film Capacitors MKT Radial Potted Types



FEATURES

- Material categorization: for definitions of compliance please see www.vishay.com/doc?99912



RoHS
COMPLIANT
HALOGEN
FREE
GREEN
(5-2008)

APPLICATIONS

Blocking, bypassing, filtering and timing, high frequency coupling and decoupling for fast digital and analog ICs, interference suppression in low voltage applications.

QUICK REFERENCE DATA	
Capacitance range	1 nF to 1.0 μ F (E12 series)
Capacitance tolerance	$\pm 20\%$ (M), $\pm 10\%$ (K), $\pm 5\%$ (J)
Climatic testing class according to IEC 60068-1	55/100/56 for rated voltage 63 V 55/105/56 for rated voltage > 63 V
Reference specifications	IEC 60384-2
Dielectric	Polyester film
Electrodes	Metallized
Construction	Mono construction 
Encapsulation	Flame retardant plastic case and epoxy resin sealed (UL-class 94 V-0)
Leads	Tinned wire
Marking	Manufacturer's logo/type/C-value/rated voltage/tolerance/date of manufacture
Rated DC voltage	63 V _{DC} , 100 V _{DC} , 250 V _{DC} , 400 V _{DC}
Rated AC voltage	40 V _{AC} , 63 V _{AC} , 160 V _{AC} , 200 V _{AC}
Rated temperature	85 °C
Maximum application temperature	100 °C for rated voltage 63 V 105 °C for rated voltage > 63 V
Performance grade	1 (long life)

Note

- For more detailed data and test requirements, contact dc-film@vishay.com

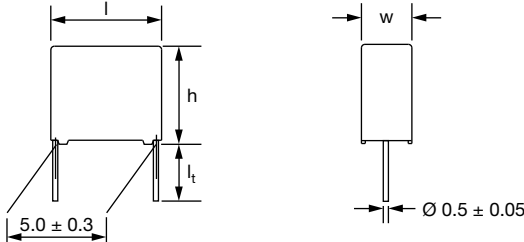
DIMENSIONS in millimeters



COMPOSITION OF CATALOG NUMBER



SPECIFIC REFERENCE DATA				
DESCRIPTION		VALUE		
Tangent of loss angle:		at 1 kHz		at 100 kHz
		$C \leq 0.1 \mu\text{F}$	$\leq 80 \times 10^{-4}$	$\leq 150 \times 10^{-4}$
$0.1 \mu\text{F} < C \leq 1.0 \mu\text{F}$		$\leq 80 \times 10^{-4}$	$\leq 150 \times 10^{-4}$	-
PITCH (mm)	RATED VOLTAGE PULSE SLOPE (dU/dt) _R AT			
	63 V _{DC}	100 V _{DC}	250 V _{DC}	400 V _{DC}
5	60	110	330	630
If the maximum pulse voltage is less than the rated voltage higher dV/dt values can be permitted.				
R between leads, for $C \leq 0.33 \mu\text{F}$ and $U_R \leq 100 \text{ V}$		> 15 000 MΩ		
R between leads, for $C \leq 0.33 \mu\text{F}$ and $U_R > 100 \text{ V}$		> 30 000 MΩ		
RC between leads, for $C > 0.33 \mu\text{F}$ and $U_R \leq 100 \text{ V}$		> 5000 s		
RC between leads, for $C > 0.33 \mu\text{F}$ and $U_R > 100 \text{ V}$		> 10 000 s		
R between interconnecting leads and casing 100 V (foil method)		> 30 000 MΩ		
Withstanding (DC) voltage (cut off current 10 mA) ⁽¹⁾ ; rise time $\leq 1000 \text{ V/s}$		$1.6 \times U_{\text{RDC}}$, 1 min		
Withstanding (DC) voltage between leads and case		$2.0 \times U_{\text{RDC}}$, with minimum of 200 V _{DC} ; 1 min		
Maximum application temperature		100 °C for rated voltage 63 V 105 °C for rated voltage > 63 V		

Note

⁽¹⁾ See "Voltage Proof Test for Metalized Film Capacitors": www.vishay.com/doc?28169



ELECTRICAL DATA					
U_{RDC} (V)	CAP. (μ F)	CAPACITANCE CODE	VOLTAGE CODE	V_{AC}	DIMENSIONS w x h x l (mm)
63	0.10	-410	06	40	2.5 x 6.5 x 7.2
	0.15	-415			2.5 x 6.5 x 7.2
	0.22	-422			3.5 x 8.0 x 7.2
	0.33	-433			3.5 x 8.0 x 7.2
	0.47	-447			3.5 x 8.0 x 7.2
	0.68	-468			4.5 x 9.0 x 7.2
	1.0	-510			6.0 x 11.0 x 7.2
100	0.022	-322	01	63	2.5 x 6.5 x 7.2
	0.033	-333			2.5 x 6.5 x 7.2
	0.047	-347			2.5 x 6.5 x 7.2
	0.068	-368			2.5 x 6.5 x 7.2
	0.10	-410			2.5 x 6.5 x 7.2
	0.15	-415			3.5 x 8.0 x 7.2
	0.22	-422			4.5 x 9.0 x 7.2
	0.33	-433			4.5 x 9.0 x 7.2
250	0.0033	-233	25	160	2.5 x 6.5 x 7.2
	0.0047	-247			2.5 x 6.5 x 7.2
	0.0068	-268			2.5 x 6.5 x 7.2
	0.010	-310			2.5 x 6.5 x 7.2
	0.015	-315			2.5 x 6.5 x 7.2
	0.022	-322			3.5 x 8.0 x 7.2
	0.033	-333			3.5 x 8.0 x 7.2
	0.047	-347			4.5 x 9.0 x 7.2
	0.068	-368			6.0 x 11.0 x 7.2
	0.10	-410			6.0 x 11.0 x 7.2
	250	0.0033			-233
0.0047		-247	2.5 x 6.5 x 7.2		
0.0068		-268	2.5 x 6.5 x 7.2		
0.010		-310	2.5 x 6.5 x 7.2		
0.015		-315	2.5 x 6.5 x 7.2		
0.022		-322	3.5 x 8.0 x 7.2		
0.033		-333	3.5 x 8.0 x 7.2		
0.047		-347	4.5 x 9.0 x 7.2		
0.068		-368	6.0 x 11.0 x 7.2		
0.10		-410	6.0 x 11.0 x 7.2		
400		0.0010	-210	40	200
	0.0015	-215	2.5 x 6.5 x 7.2		
	0.0022	-222	2.5 x 6.5 x 7.2		
	0.0033	-233	2.5 x 6.5 x 7.2		
	0.0047	-247	2.5 x 6.5 x 7.2		
	0.0068	-268	2.5 x 6.5 x 7.2		
	0.010	-310	3.5 x 8.0 x 7.2		
	0.015	-315	3.5 x 8.0 x 7.2		
	0.022	-322	4.5 x 9.0 x 7.2		

RECOMMENDED PACKAGING					
PACKAGING CODE	TYPE OF PACKAGING	HEIGHT (H) (mm)	REEL DIAMETER (mm)	ORDERING CODE EXAMPLES	PITCH 5
G	Ammo	18.5	S ⁽¹⁾	MKT1817233255G	x
W	Reel	18.5	350	MKT1817233255W	x
-	Bulk	-	-	MKT1817233255	x

Note

⁽¹⁾ S = box size 55 mm x 210 mm x 340 mm (w x h x l)



MOUNTING

Normal Use

The capacitors are designed for mounting on printed-circuit boards. The capacitors packed in bandoliers are designed for mounting in printed-circuit boards by means of automatic insertion machines.

For detailed tape specifications refer to packaging information www.vishay.com/docs?28139

Specific Method of Mounting to Withstand Vibration and Shock

In order to withstand vibration and shock tests, it must be ensured that the stand-off pips are in good contact with the printed-circuit board.

- For pitches ≤ 15 mm the capacitors shall be mechanically fixed by the leads
- For larger pitches the capacitors shall be mounted in the same way and the body clamped

Space Requirements on Printed-Circuit Board

The maximum space for length ($l_{max.}$), width ($w_{max.}$) and height ($h_{max.}$) of film capacitors to take in account on the printed-circuit board is shown in the drawings.

- For products with pitch ≤ 15 mm, $\Delta w = \Delta l = 0.3$ mm; $\Delta h = 0.1$ mm

Eccentricity defined as in drawing. The maximum eccentricity is smaller than or equal to the lead diameter of the product concerned.

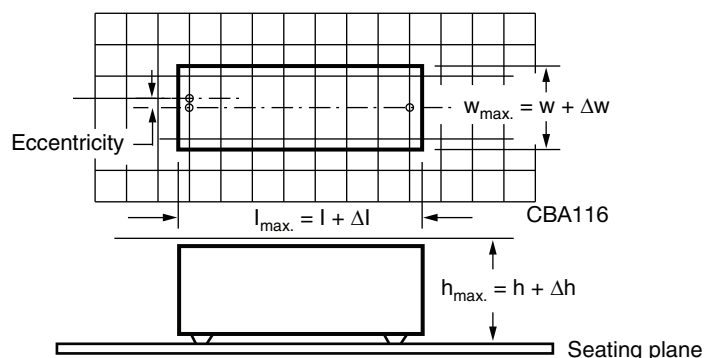

SOLDERING CONDITIONS

For general soldering conditions and wave soldering profile, we refer to the document “Characteristics and Definitions Used for Film Capacitors”: www.vishay.com/doc?28147

Storage Temperature

$T_{stg} = -25$ °C to $+35$ °C with RH maximum 75 % without condensation

Ratings and Characteristics Reference Conditions

Unless otherwise specified, all electrical values apply to an ambient free air temperature of 23 °C ± 1 °C, an atmospheric pressure of 86 kPa to 106 kPa and a relative humidity of 50 % ± 2 %.

For reference testing, a conditioning period shall be applied over 96 h ± 4 h by heating the products in a circulating air oven at the rated temperature and a relative humidity not exceeding 20 %.



CHARACTERISTICS

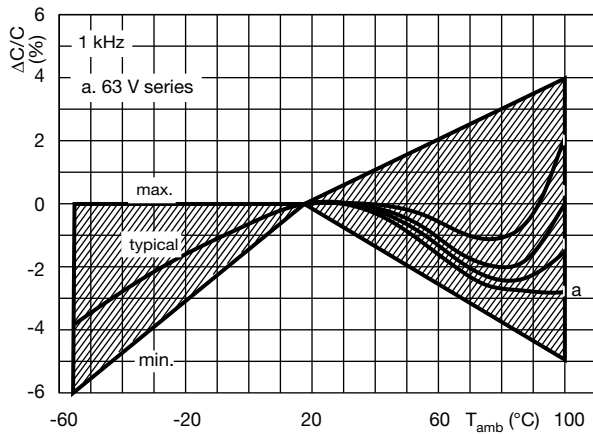

Capacitance as a function of ambient temperature (typical) for voltage 63 V

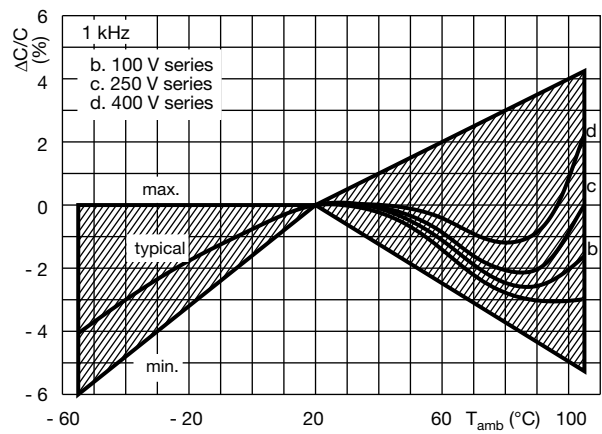

Capacitance as a function of ambient temperature (typical) for voltages > 63 V

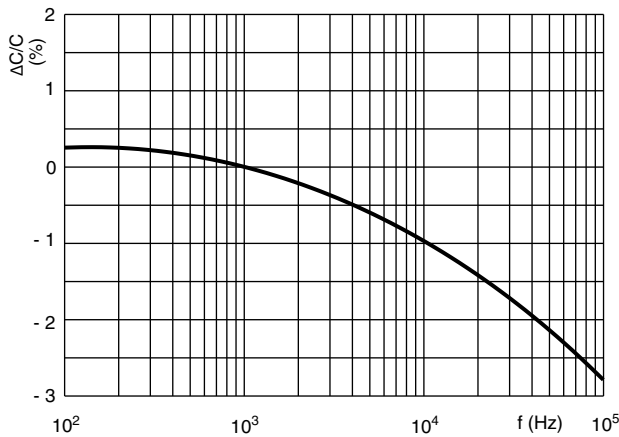

Capacitance as a function of frequency (typical curve)

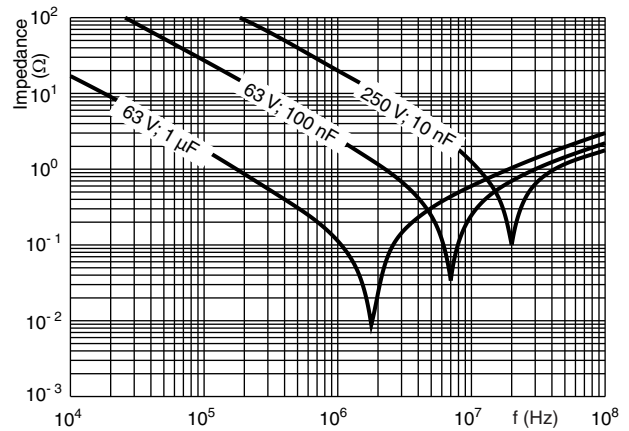

Impedance as a function of frequency

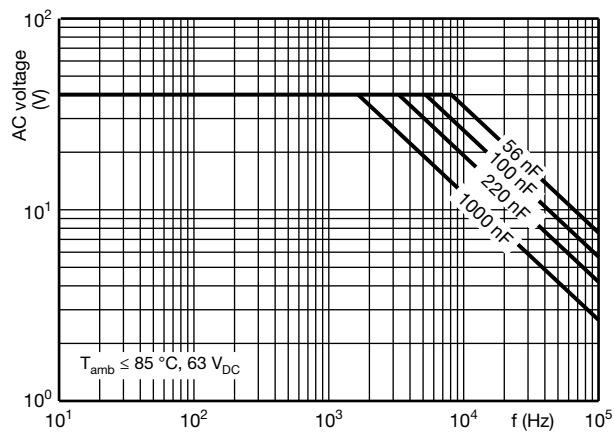

Max. AC voltage as a function of frequency

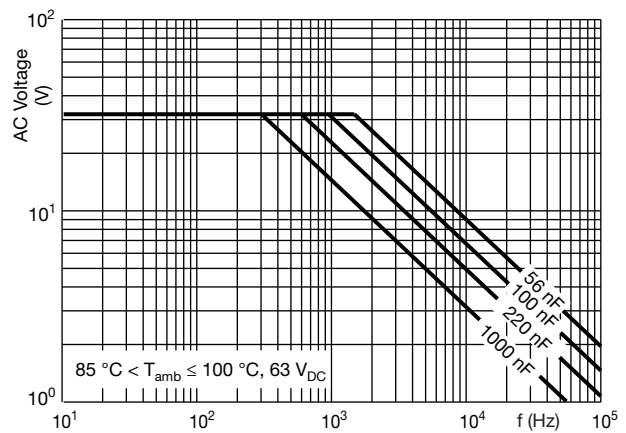

Max. AC voltage as a function of frequency



Max. AC voltage as a function of frequency



Max. AC voltage as a function of frequency



Max. AC voltage as a function of frequency



Max. AC voltage as a function of frequency



Max. AC voltage as a function of frequency



Max. AC voltage as a function of frequency



Maximum RMS Current (Sinewave) as a Function of Frequency

The maximum RMS current is defined by $I_{ac} = \omega \times C \times U_{ac}$.

U_{AC} is the maximum AC voltage depending on the ambient temperature in the curves "Max. RMS voltage and AC current as a function of frequency".

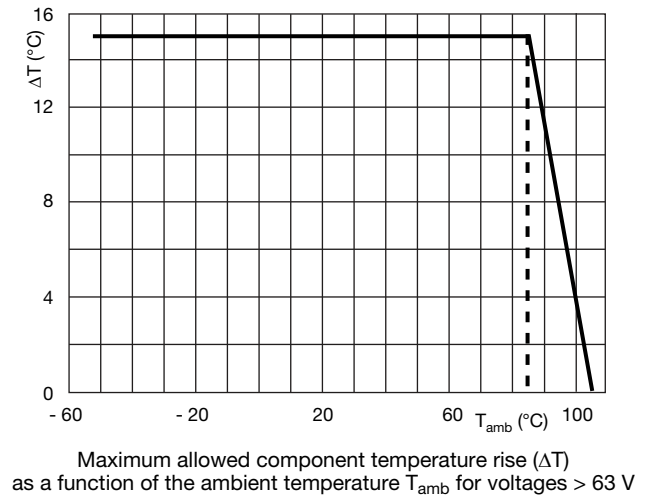
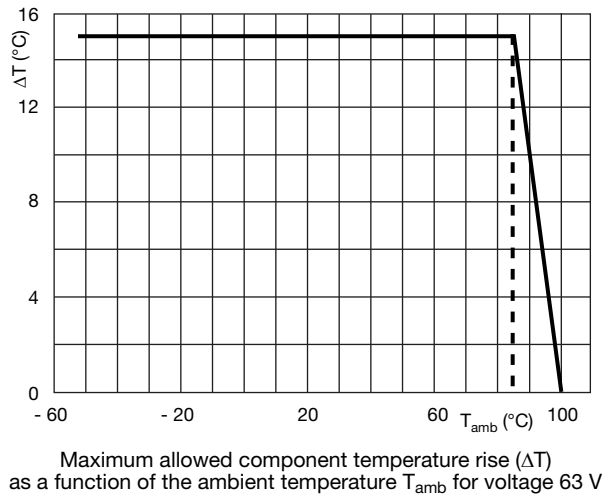
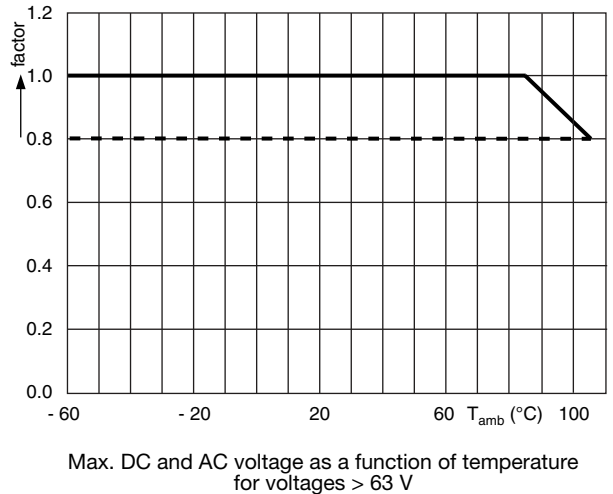
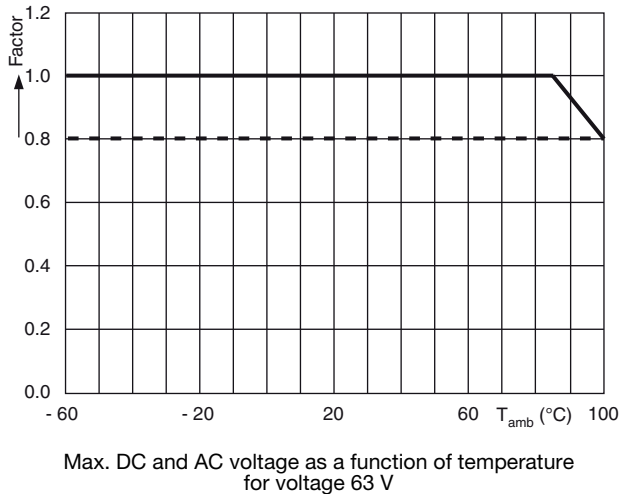
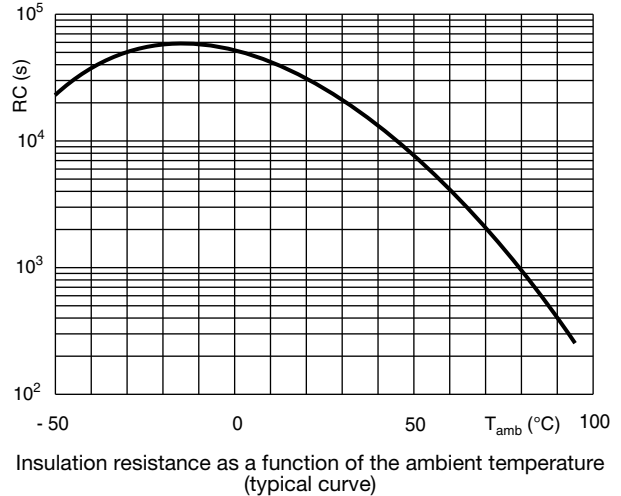
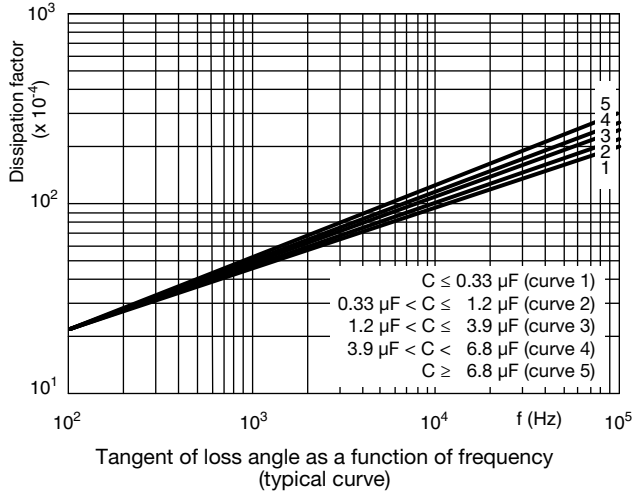



HEAT CONDUCTIVITY (G) AS A FUNCTION OF (ORIGINAL) PITCH AND CAPACITOR BODY THICKNESS IN mW/°C	
W_{max.} (mm)	HEAT CONDUCTIVITY (mW/°C)
	PITCH 5 mm
2.5	2.5
3.0	3.0
4.5	4.0
6.0	5.5

POWER DISSIPATION AND MAXIMUM COMPONENT TEMPERATURE RISE

The power dissipation must be limited in order not to exceed the maximum allowed component temperature rise as a function of the free ambient temperature.

The power dissipation can be calculated according type detail specification “HQN-384-01/101: Technical Information Film Capacitors”.

The component temperature rise (ΔT) can be measured (see section “Measuring the Component Temperature” for more details) or calculated by $\Delta T = P/G$:

- ΔT = component temperature rise (°C)
- P = power dissipation of the component (mW)
- G = heat conductivity of the component (mW/°C)

MEASURING THE COMPONENT TEMPERATURE

A thermocouple must be attached to the capacitor body as in:

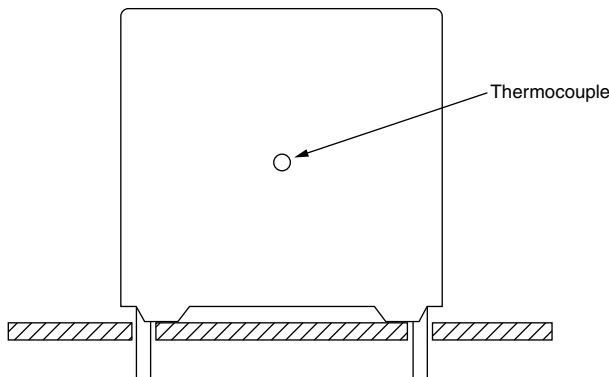

The temperature is measured in unloaded (T_{amb}) and maximum loaded condition (T_C).

The temperature rise is given by $\Delta T = T_C - T_{amb}$.

To avoid radiation or convection, the capacitor should be tested in a wind-free box.



APPLICATION NOTE AND LIMITING CONDITIONS

These capacitors are not suitable for mains applications as across-the-line capacitors without additional protection, as described hereunder. These mains applications are strictly regulated in safety standards and therefore electromagnetic interference suppression capacitors conforming the standards must be used.

For capacitors connected in parallel, normally the proof voltage and possibly the rated voltage must be reduced. For information depending of the capacitance value and the number of parallel connections contact: dc-film@vishay.com

To select the capacitor for a certain application, the following conditions must be checked:

1. The peak voltage (U_P) shall not be greater than the rated DC voltage (U_{RDC})
2. The peak-to-peak voltage (U_{P-P}) shall not be greater than $2\sqrt{2} \times U_{RAC}$ to avoid the ionization inception level
3. The voltage peak slope (dU/dt) shall not exceed the rated voltage pulse slope in an RC-circuit at rated voltage and without ringing. If the pulse voltage is lower than the rated DC voltage, the rated voltage pulse slope may be multiplied by U_{RDC} and divided by the applied voltage.

For all other pulses following equation must be fulfilled:

$$2 \times \int_0^T \left(\frac{dU}{dt}\right)^2 \times dt < U_{RDC} \times \left(\frac{dU}{dt}\right)_{rated}$$

T is the pulse duration.

4. The maximum component surface temperature rise must be lower than the limits (see graph "Max. allowed component temperature rise").
5. Since in circuits used at voltages over 280 V peak-to-peak the risk for an intrinsically active flammability after a capacitor breakdown (short circuit) increases, it is recommended that the power to the component is limited to 100 times the values mentioned in the table: "Heat Conductivity"
6. When using these capacitors as across-the-line capacitor in the input filter for mains applications or as series connected with an impedance to the mains the applicant must guarantee that the following conditions are fulfilled in any case (spikes and surge voltages from the mains included).

VOLTAGE CONDITIONS FOR 6 ABOVE		
ALLOWED VOLTAGES	$T_{amb} \leq 85\text{ }^\circ\text{C}$	$85\text{ }^\circ\text{C} < T_{amb} \leq 100\text{ }^\circ\text{C FOR 63 V}$
		$85\text{ }^\circ\text{C} < T_{amb} \leq 100\text{ }^\circ\text{C FOR } > 63\text{ V}$
Maximum continuous RMS voltage	U_{RAC}	See "Max. AC voltage as function of temperature" per characteristics
Maximum temperature RMS-overvoltage (< 24 h)	$1.25 \times U_{RAC}$	U_{RAC}
Maximum peak voltage (V_{O-P}) (< 2 s)	$1.6 \times U_{RDC}$	$1.3 \times U_{RDC}$

Example

C = 330 nF - 63 V used for the voltage signal shown in next drawing.

$U_{P-P} = 40\text{ V}$; $U_P = 35\text{ V}$; $T_1 = 100\text{ }\mu\text{s}$; $T_2 = 200\text{ }\mu\text{s}$

The ambient temperature is $35\text{ }^\circ\text{C}$

Checking conditions:

1. The peak voltage $U_P = 35\text{ V}$ is lower than 63 V_{DC}
2. The peak-to-peak voltage 40 V is lower than $2\sqrt{2} \times 40\text{ V}_{AC} = 113\text{ V}_{P-P}$
3. The voltage pulse slope (dU/dt) = $40\text{ V}/100\text{ }\mu\text{s} = 0.4\text{ V}/\mu\text{s}$
This is lower than $60\text{ V}/\mu\text{s}$ (see specific reference data for each version)
4. The dissipated power is 16.2 mW as calculated with fourier terms
The temperature rise for $w_{max} = 3.5\text{ mm}$ and pitch = 5 mm will be $16.2\text{ mW}/3.0\text{ mW}/^\circ\text{C} = 5.4\text{ }^\circ\text{C}$
This is lower than $15\text{ }^\circ\text{C}$ temperature rise at $35\text{ }^\circ\text{C}$, according figure "Max. allowed component temperature rise"
5. Not applicable
6. Not applicable

Voltage Signal

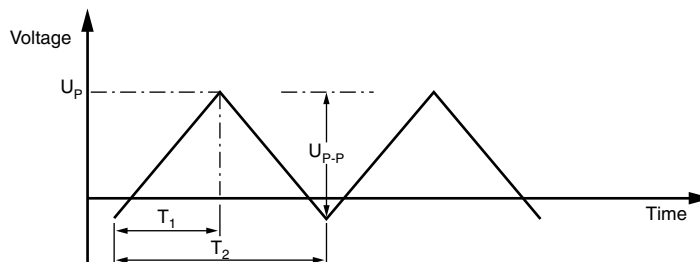



INSPECTION REQUIREMENTS

General Notes

Sub-clause numbers of tests and performance requirements refer to the “Sectional Specification, Publication IEC 60384-2 and Specific Reference Data”.

GROUP C INSPECTION REQUIREMENTS		
SUB-CLAUSE NUMBER AND TEST	CONDITIONS	PERFORMANCE REQUIREMENTS
SUB-GROUP C1A PART OF SAMPLE OF SUB-GROUP C1		
4.1 Dimensions (detail)		As specified in chapters “MKT370 General Data” of this specification
4.3.1 Initial measurements	Capacitance Tangent of loss angle: for C ≤ 470 nF at 100 kHz for C > 470 nF at 10 kHz	
4.3 Robustness of terminations	Tensile and bending	No visible damage
4.4 Resistance to soldering heat	Method: 1A Solder bath: 280 °C ± 5 °C Duration: 10 s	
4.14 Component solvent resistance	Isopropylalcohol at room temperature Method: 2 Immersion time: 5 min ± 0.5 min Recovery time: min. 1 h, max. 2 h	
4.4.2 Final measurements	Visual examination Capacitance Tangent of loss angle	No visible damage Legible marking ΔC/C ≤ 2 % of the value measured initially Increase of tan δ: ≤ 0.005 for: C ≤ 100 nF or ≤ 0.010 for: 100 nF < C ≤ 220 nF or ≤ 0.015 for: 220 nF < C ≤ 470 nF or ≤ 0.003 for: C > 470 nF Compared to values measured in 4.3.1
SUB-GROUP C1B OTHER PART OF SAMPLE OF SUB-GROUP C1		
4.6.1 Initial measurements	Capacitance Tangent of loss angle: for C ≤ 470 nF at 100 kHz for C > 470 nF at 10 kHz	
4.6 Rapid change of temperature	θA = -55 °C θB = +100 °C 5 cycles Duration t = 30 min	
4.7 Vibration	Visual examination Mounting: see section “Mounting” of this specification Procedure B4 Frequency range: 10 Hz to 55 Hz Amplitude: 0.75 mm or Acceleration 98 m/s ² (whichever is less severe) Total duration 6 h	No visible damage



GROUP C INSPECTION REQUIREMENTS		
SUB-CLAUSE NUMBER AND TEST	CONDITIONS	PERFORMANCE REQUIREMENTS
SUB-GROUP C1B OTHER PART OF SAMPLE OF SUB-GROUP C1		
4.7.2 Final inspection	Visual examination	No visible damage
4.9 Shock	Mounting: see section "Mounting" of this specification Pulse shape: half sine Acceleration: 490 m/s ² Duration of pulse: 11 ms	
4.9.3 Final measurements	Visual examination	No visible damage
	Capacitance	$ \Delta C/C \leq 3\%$ of the value measured in 4.6.1
	Tangent of loss angle	Increase of $\tan \delta$: ≤ 0.010 for: $C \leq 220$ nF or ≤ 0.015 for: 220 nF < $C \leq 470$ nF or ≤ 0.003 for: $C > 470$ nF Compared to values measured in 4.6.1
	Insulation resistance	As specified in section "Specific Reference Data 370" of this specification
SUB-GROUP C1 COMBINED SAMPLE OF SPECIMENS OF SUB-GROUPS C1A AND C1B		
4.10 Climatic sequence		
4.10.2 Dry heat	Temperature: +100 °C for rated voltage 63 V +105 °C for rated voltage > 63 V Duration: 16 h	
4.10.3 Damp heat cyclic Test Db, first cycle		
4.10.4 Cold	Temperature: -55 °C Duration: 2 h	
4.10.6 Damp heat cyclic Test Db, remaining cycles	Voltage proof = U_{RDC} for 1 min within 15 min after removal from test chamber	No breakdown or flash-over
4.10.6.2 Final measurements	Visual examination	No visible damage Legible marking
	Capacitance	$ \Delta C/C \leq 3\%$ of the value measured in 4.4.2 or 4.9.3
	Tangent of loss angle	Increase of $\tan \delta$: ≤ 0.010 for: $C \leq 220$ nF or ≤ 0.015 for: 220 nF < $C \leq 470$ nF or ≤ 0.005 for: $C > 470$ nF Compared to values measured in 4.3.1 or 4.6.1
	Insulation resistance	$\geq 50\%$ of values specified in section "Specific Reference Data 370" of this specification



GROUP C INSPECTION REQUIREMENTS		
SUB-CLAUSE NUMBER AND TEST	CONDITIONS	PERFORMANCE REQUIREMENTS
SUB-GROUP C2		
4.11 Damp heat steady state	56 days, 40 °C, 90 % to 95 % RH	
4.11.1 Initial measurements	Capacitance Tangent of loss angle at 1 kHz	
4.11.3 Final measurements	Voltage proof = U_{RDC} for 1 min within 15 min after removal from testchamber	No breakdown or flash-over
	Visual examination	No visible damage Legible marking
	Capacitance	$ \Delta C/C \leq 5\%$ of the value measured in 4.11.1.
	Tangent of loss angle	Increase of $\tan \delta: \leq 0.005$ Compared to values measured in 4.11.1
	Insulation resistance	$\geq 50\%$ of values specified in section "Specific Reference Data 370" of this specification
SUB GROUP C3		
4.12 Endurance	Duration: 2000 h 1.25 x U_{RDC} at 85 °C 0.8 x 1.25 U_{RDC} at 100 °C for rated voltage 63 V 0.8 x 1.25 U_{RDC} at 105 °C for rated voltage > 63 V	
4.12.1 Initial measurements	Capacitance Tangent of loss angle: for $C \leq 470$ nF at 100 kHz for $C > 470$ nF at 10 kHz	
4.12.5 Final measurements	Visual examination	No visible damage Legible marking
	Capacitance	$ \Delta C/C \leq 5\%$ compared to values measured in 4.12.1
	Tangent of loss angle	Increase of $\tan \delta$: ≤ 0.005 at 85 °C ≤ 0.010 at 100 °C for: $C \leq 220$ nF or ≤ 0.015 for: 220 nF < $C \leq 470$ nF or ≤ 0.003 for: $C > 470$ nF Compared to values measured in 4.12.1
	Insulation resistance	$\geq 50\%$ of values specified in section "Specific Reference Data 370" of this specification



GROUP C INSPECTION REQUIREMENTS		
SUB-CLAUSE NUMBER AND TEST	CONDITIONS	PERFORMANCE REQUIREMENTS
SUB-GROUP C4		
4.13 Charge and discharge	10 000 cycles Charged to U_{RDC} Discharge resistance: $R = \frac{U_R}{C \times 2.5 \times (dU/dt)_R}$	
4.13.1 Initial measurements	Capacitance Tangent of loss angle: for $C \leq 470$ nF at 100 kHz for $C > 470$ nF at 10 kHz	
4.13.3 Final measurements	Capacitance Tangent of loss angle Insulation resistance	$ \Delta C/C \leq 3\%$ compared to values measured in 4.13.1 Increase of $\tan \delta$: ≤ 0.005 for: $C \leq 100$ nF or ≤ 0.010 for: 100 nF $< C \leq 220$ nF or ≤ 0.015 for: 220 nF $< C \leq 470$ nF or ≤ 0.003 for: $C > 470$ nF Compared to values measured in 4.13.1 $\geq 50\%$ of values specified in section "Specific Reference Data 370" of this specification



Disclaimer

ALL PRODUCT, PRODUCT SPECIFICATIONS AND DATA ARE SUBJECT TO CHANGE WITHOUT NOTICE TO IMPROVE RELIABILITY, FUNCTION OR DESIGN OR OTHERWISE.

Vishay Intertechnology, Inc., its affiliates, agents, and employees, and all persons acting on its or their behalf (collectively, "Vishay"), disclaim any and all liability for any errors, inaccuracies or incompleteness contained in any datasheet or in any other disclosure relating to any product.

Vishay makes no warranty, representation or guarantee regarding the suitability of the products for any particular purpose or the continuing production of any product. To the maximum extent permitted by applicable law, Vishay disclaims (i) any and all liability arising out of the application or use of any product, (ii) any and all liability, including without limitation special, consequential or incidental damages, and (iii) any and all implied warranties, including warranties of fitness for particular purpose, non-infringement and merchantability.

Statements regarding the suitability of products for certain types of applications are based on Vishay's knowledge of typical requirements that are often placed on Vishay products in generic applications. Such statements are not binding statements about the suitability of products for a particular application. It is the customer's responsibility to validate that a particular product with the properties described in the product specification is suitable for use in a particular application. Parameters provided in datasheets and/or specifications may vary in different applications and performance may vary over time. All operating parameters, including typical parameters, must be validated for each customer application by the customer's technical experts. Product specifications do not expand or otherwise modify Vishay's terms and conditions of purchase, including but not limited to the warranty expressed therein.

Except as expressly indicated in writing, Vishay products are not designed for use in medical, life-saving, or life-sustaining applications or for any other application in which the failure of the Vishay product could result in personal injury or death. Customers using or selling Vishay products not expressly indicated for use in such applications do so at their own risk. Please contact authorized Vishay personnel to obtain written terms and conditions regarding products designed for such applications.

No license, express or implied, by estoppel or otherwise, to any intellectual property rights is granted by this document or by any conduct of Vishay. Product names and markings noted herein may be trademarks of their respective owners.

Material Category Policy

Vishay Intertechnology, Inc. hereby certifies that all its products that are identified as RoHS-Compliant fulfill the definitions and restrictions defined under Directive 2011/65/EU of The European Parliament and of the Council of June 8, 2011 on the restriction of the use of certain hazardous substances in electrical and electronic equipment (EEE) - recast, unless otherwise specified as non-compliant.

Please note that some Vishay documentation may still make reference to RoHS Directive 2002/95/EC. We confirm that all the products identified as being compliant to Directive 2002/95/EC conform to Directive 2011/65/EU.

Vishay Intertechnology, Inc. hereby certifies that all its products that are identified as Halogen-Free follow Halogen-Free requirements as per JEDEC JS709A standards. Please note that some Vishay documentation may still make reference to the IEC 61249-2-21 definition. We confirm that all the products identified as being compliant to IEC 61249-2-21 conform to JEDEC JS709A standards.