

MOSA M8 FEMALE 0° FIELD-WIREABLE (IDC)

4-pol., 0,14-0,34mm²

Female straight

4-pole

Insulation displacement technology

Connection cross section: 0.14...0.34 mm²

[Link to Product](#)

Illustration

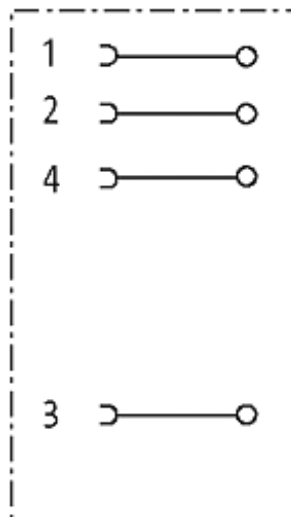

Female

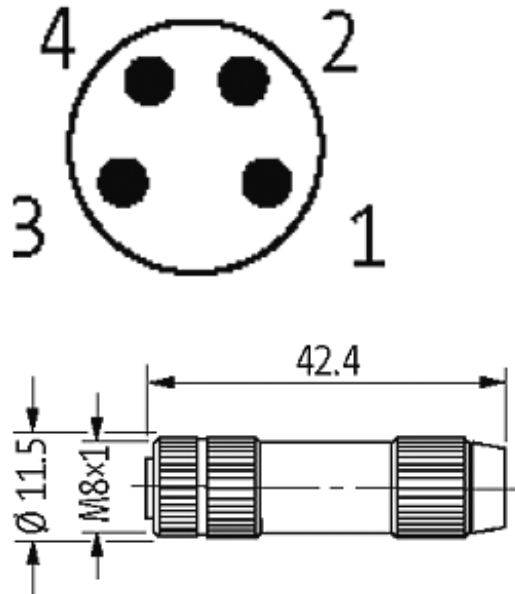

Product may differ from Image

Approvals



Form

08391

Technical Data

Operating voltage	max. 32 V AC/DC
Operating current per contact	max. 4 A
Connection cross section	0.14...0.34 mm ² (conductor diameter min. 0.1 mm)
Sealing range (cable diameter)	2.5...5.1 mm (gasket included)
Wire isolation	PVC, PP, TPE
Outer wire diameter	1.0...1.6 mm
Protection	IP67 inserted and tightened (EN 60529)

General data

Temperature range	-25...+85 °C
Dimensions H × W × D	42.5×11.8×11.8 mm

Commercial data

country of origin	DE
-------------------	----

customs tariff number	85369010
minimum order quantity	1
