

M23 FEMALE 19 POLE 90°

PUR 8x0,5+3x1,0 GRAY, drag ch 15m

M23

Female 90°

19-pole

11-pole used

for 4-way distribution boxes, 5-pole

Further cable lengths on request. Plastic housings with good resistance against chemicals and oils. The resistance to aggressive media should be individually tested for your application. Further details on request.

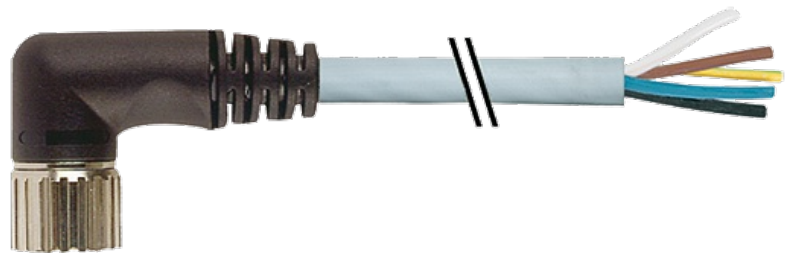
[Link to Product](#)**Illustration**

15	white
7	gray/pink
5	green
4	red/blue
	yellow
16	white/green
8	gray
3	brown/green
14	brown 1.0 mm ²
19	blue 1.0 mm ²
6	green/yellow 1.0 mm ²
12	

Female

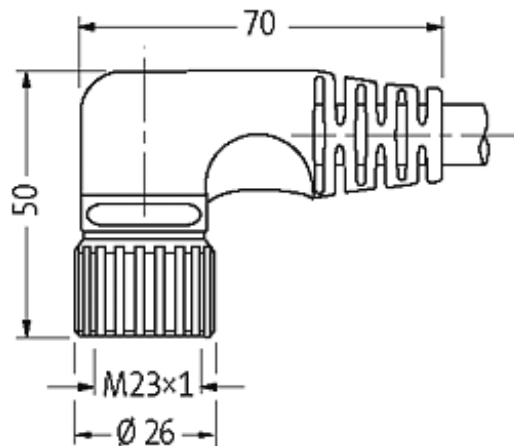
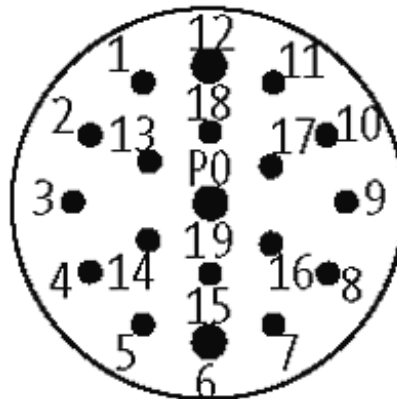

Product may differ from Image

Cables

Cable number	448
No./diameter of wires	8×0.5 + 3×1.0 mm ²
Wire isolation	TPE (grpk, wh, rdbl, gn, whgn, ye, brgn, gr, br, bl, gnye)
C-track properties	5 Mio.
Jacket Color	gray
Shore hardness outer jacket	94 ± 5A
Material (jacket)	PUR (UL/CSA)
Outer diameter	approx. 9.1 mm
Bend radius (fixed)	5 × outer Ø
Bend radius (moving)	10 × outer Ø
Temperature range (fixed)	-40...+80 °C
Temperature range (mobile)	-5...+80 °C

General data

Temperature range -25...+85 °C, depending on cable quality

Commercial data

country of origin DE

customs tariff number	85444290
minimum order quantity	1
