

Type	Ordering code	Package
TDA 4942	Q67000-A1926	DIP 16

The TDA 4942 contains a switchable matrix with tristate input to provide *L-R* information. The switch input is controlled by the immediately preceding pilot tone decoding IC TDA 4940. During dual operation the subsequent analog switch enables the selection of audio I or audio II. The LED driver displays the position of the analog switch, and/or stereo or mono operation. The analog switch controls the audio tape recorder output as well as the AF output. This output is equipped with a dc voltage regulated volume and balance control.

Features

- Switchable matrix
- Tape recorder output
- Volume and balance control
- All outputs are short-circuit resistant

Maximum ratings

Supply voltage (1 minute)	V_S	16.5	V
Junction temperature	T_j	150	°C
Storage temperature range	T_{stg}	-40 to 125	°C
Thermal resistance (system-air)	$R_{th SA}$	70	K/W

Operating range

Supply voltage	V_S	10 to 15.8	V
Frequency (-1 dB)	f_i	20 to 20,000	Hz
Ambient temperature	T_A	0 to 70	°C

Characteristics

 $V_S = 12\text{ V}$; $T_A = 25\text{ }^\circ\text{C}$

		min	typ	max	
Total current consumption (without LED)	I_{S12}		15		mA
LED driver current (each LED)	$I_{LED\ 3,4}$	10	15		mA
Reference voltage	$V_{REF\ 5}$		4.8		V
Input resistance audio I	R_{i2}		15		k Ω
Input resistance audio II	R_{i16}		30		k Ω
Input current of the adjust. input	$I_{ad\ 7,10}$		3.5		μA
Input current of the switch	$I_{sw\ 6}$		20		μA
Input voltage audio I (THD = 0.7%)	$V_{i2\ rms}$		150	600	mV
Input voltage audio II (THD = 0.7%)	$V_{i16\ rms}$		300	1200	mV
Output voltage tape rec. output $V_{i2} = 150\text{ mV}$	$V_{q\ TR\ 11,13\ rms}$		150		mV
Output voltage tape rec. output $V_{i16} = 300\text{ mV}$	$V_{q\ TR\ 11,13\ rms}$		150		mV
AF output voltage $V_{i2} = 150\text{ mV}$	$V_{q\ AF\ 8,9\ rms}$		300		mV
AF output voltage $V_{i16} = 300\text{ mV}$	$V_{q\ AF\ 8,9\ rms}$		300		mV
AGC range balance $V_{bal} = 0 \dots V_{REF}$	$G_{bal\ max}$		6		dB
AGC range balance $V_{bal} = 0 \dots V_{REF}$	$G_{bal\ min}$		-12		dB
Voltage balance center $V_{right} = V_{left}$	$V_{bal\ 7}$	0.48	$0.5 V_{REF}$	0.52	V
AGC range volume $V_{vol} = 0 \dots V_{REF}$	ΔG_{vol}	85			dB
Output resistance AF output	$R_{q\ AF\ 8,9}$		0.2		k Ω
Output resistance tape rec. output	$R_{q\ TR\ 11,13}$		0.5		k Ω
Total harmonic distortion ($V_i = 0.5$ or 1 V)	$THD_{8,9,11,13}$			0.5	%
Channel separation	$a_{L/R\ 8-9,11-13}$	60			dB
Channel deviation (volume = max)	$a_{L/R\ 8-9}$			2	dB
Disturbance voltage spacing (volume = max; $f_i = 20\text{ Hz to }20\text{ kHz}$)	$a_{S/N}$		70		dB
Noise voltage at the AF output volume = min; $f_i = 20\text{ Hz to }20\text{ kHz}$	$V_{n\ AF\ 8,9}$		10		μV
Switch input					
H input voltage \triangleq audio I (or open)	$V_{6\ H}$	4		V_S	V
L input voltage \triangleq audio II	$V_{6\ L}$	0		2.8	V
Control voltage balance $V_{qr} = \text{max}$; $V_{ql} = \text{min}$	$V_{bal\ 7}$		0		V
Control voltage balance $V_{ql} = \text{max}$; $V_{qr} = \text{min}$	$V_{bal\ 7}$		V_{REF}		V
Switch voltage matrix					
dual audio	$V_{sw\ 15}$	0		$1/6 V_S$	V
mono	$V_{sw\ 15}$	$1/3 V_S$		$2/3 V_S$	V
stereo	$V_{sw\ 15}$	$5/6 V_S$		V_S	V

Block diagram

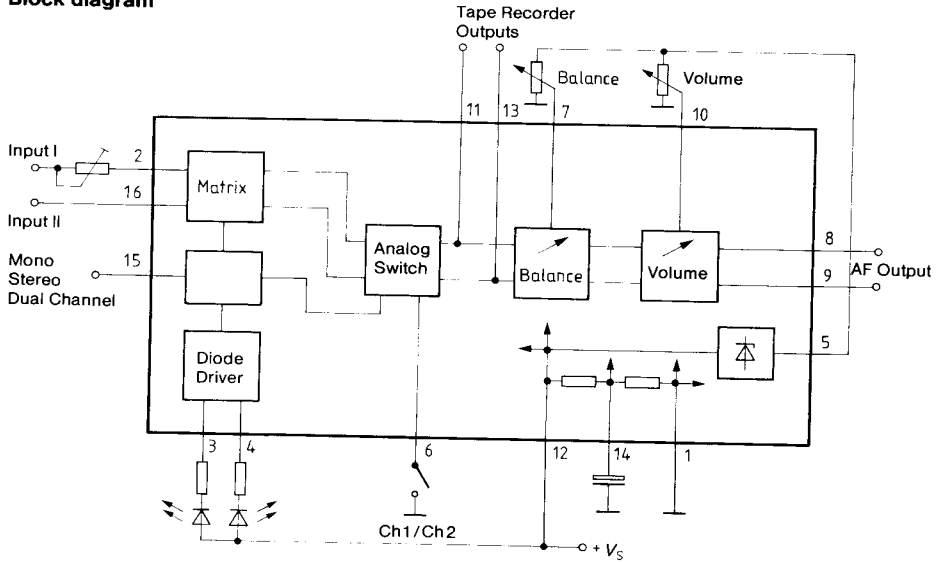

Truth table

Pin 6	Pin 15	Pin 4	Pin 3
S1/AF	Tristate input	LED 1	LED 2
Any	Stereo = V_S	ON	ON
Any	Mono = $V_S/2$	OFF	OFF
Open H	2 tone = 0 V	ON	OFF
Ground L	2 tone = 0 V	OFF	ON

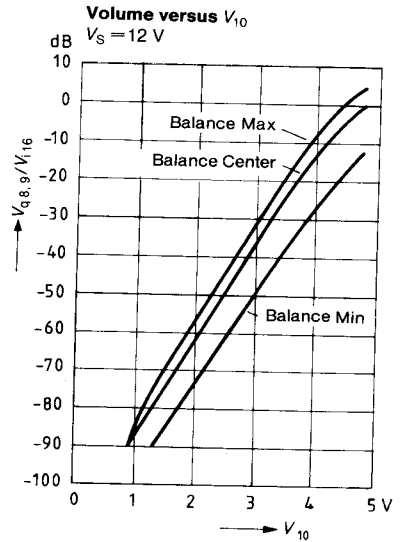

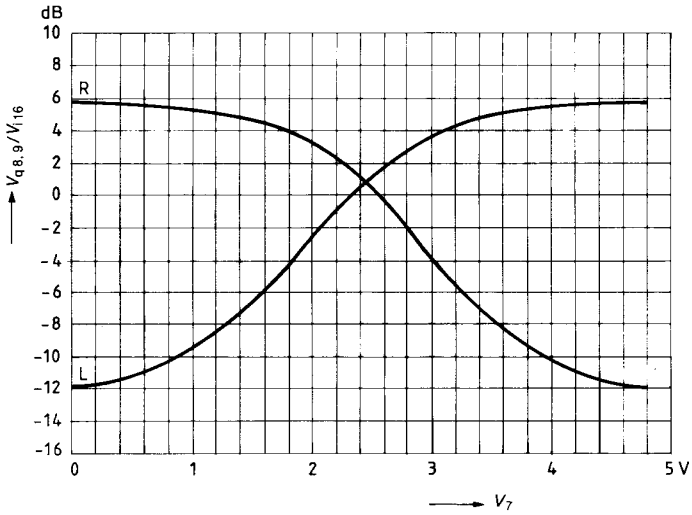
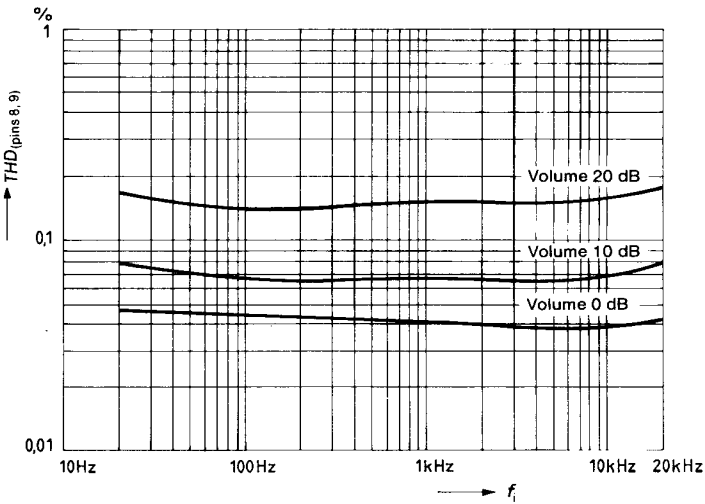
Balance versus V_7 $V_S = 12\text{ V}$; $V_{1,16\text{ rms}} = 500\text{ mV}$ **Total harmonic distortion versus input frequency** $V_S = 12\text{ V}$; $V_{\text{rms}} = 300\text{ mV}$ 

**Cross-talk rejection
Dual tone operation versus input frequency**

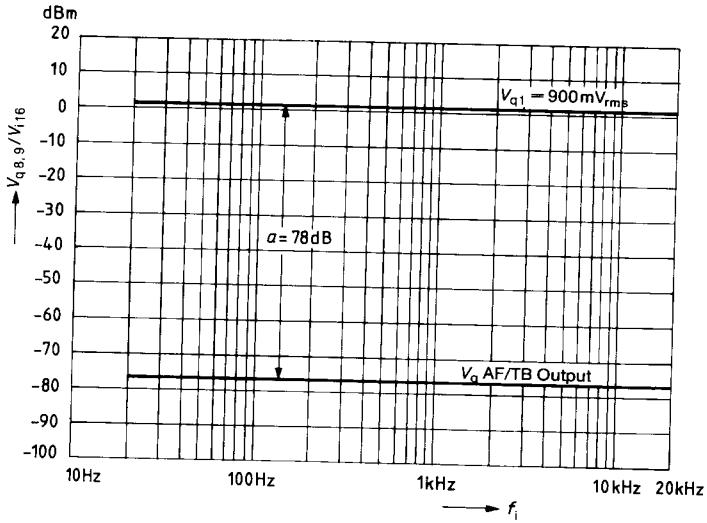

* TB = Tape recorder

Disturbance voltage spacing versus attenuation

$V_S = 12 \text{ V}$; $V_{\text{irms}} = 300 \text{ mV}$; $f_i = 1 \text{ kHz}$

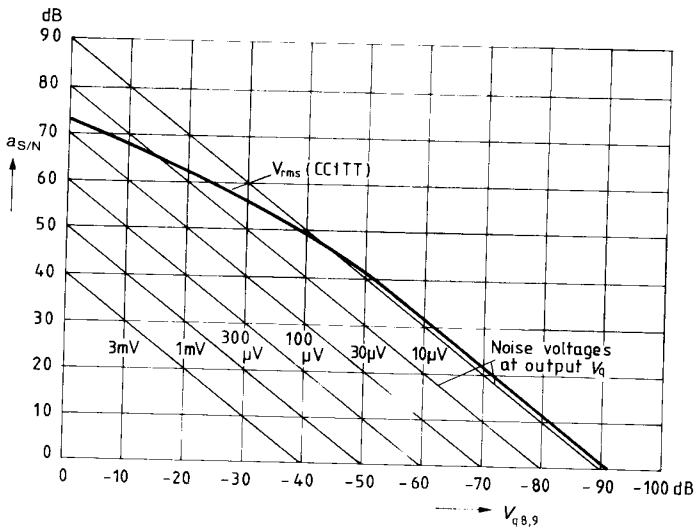

Application circuit

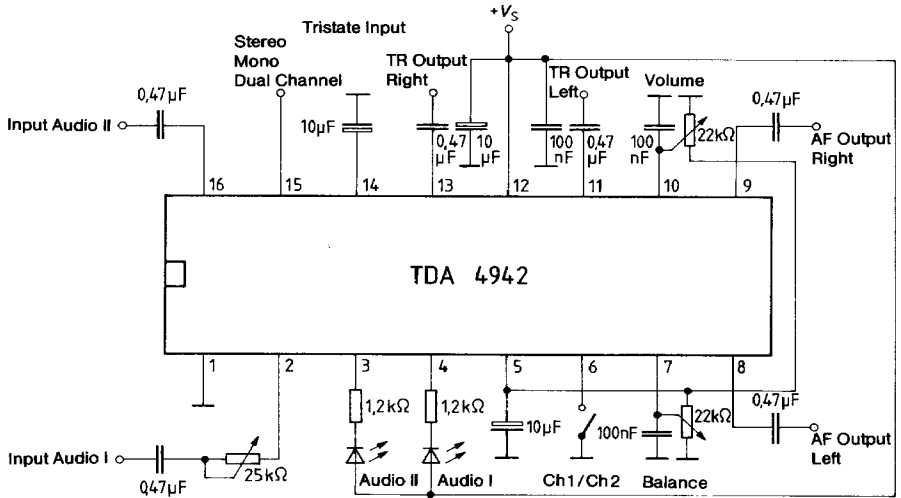

Application circuit

