

**SAI Passive
SAI-8-F 4P IDC PUR 5M**

Weidmüller Interface GmbH & Co. KG
Klingenbergstraße 16
D-32758 Detmold
Germany
Fon: +49 5231 14-0
Fax: +49 5231 14-292083
www.weidmueller.com



- The compact IDC system cuts production, installation and maintenance work.
- Knurled metal nuts ensure sturdy, secure handling with little effort.
- The IDC distributors have the same dimensions as the standard SAI distributors. They are compatible with the standard SAI distributors.
- 3-pole version with 1 I/O signal per slot and 4-pole version with 2 I/O signals per slot,
- individual assembly of the sensor/actuator cables on the spot,
- reliable and fast connection thanks to IDC connecting element,
- IP67 class of protection.

General ordering data

Type	SAI-8-F 4P IDC PUR 5M
Order No.	1766700000
Version	SAI Passive, Sensor-actuator passive distributor, IDC, M12, Fixed cable version, 5 m, Yes
GTIN (EAN)	4032248107407
Qty.	1 pc(s).

SAI Passive SAI-8-F 4P IDC PUR 5M

Weidmüller Interface GmbH & Co. KG
 Klingenbergstraße 16
 D-32758 Detmold
 Germany
 Fon: +49 5231 14-0
 Fax: +49 5231 14-292083
 www.weidmueller.com

Technische Daten

Dimensions and weights

Length	152 mm	Width	60 mm
Height	25 mm	Net weight	751 g

General data

Number of contact sockets	8	Fire behaviour	V-0
Contact tube diameter	M12	No. of poles	8
Pollution severity	2	Distributor outlet	Fixed cable version
Insulation resistance	10 ⁹ Ω	Rated voltage , max.	30 V
Rated voltage , min.	10 V	Electrical isolation available	No
Test voltage	1 kV	Current per signal	2 A
Total current	9 A	Max. current-carrying capacity per slot	4 A
Housing main material	Pocan	Housing colour	grey, RAL 7032
Screw socket	CuZn, nickel-plated	Contact material	CuZn
Contact surface	Gold-plated	Contact carrier material	PBT (UL 94 V0)
Sheathing stripping length	15 mm	Cable length	5 m
Conductor O.D.	1.2 - 1.6mm	Conductor O.D., max.	1.6 mm
Conductor O.D., min.	1.2 mm	Suitable for cable carriers	Yes
max. connection of equal cross-section	10	LED initiator	Yes
LED	Yes	LED colour for indicating operation	green
LED colour for I/O function	yellow		

Classifications

ETIM 3.0	EC001856	UNSPSC	30-21-18-01
eClass 6.2	27-06-91-90	eClass 7.1	27-06-91-90

Approvals

Approvals



ROHS

Conform

**SAI Passive
SAI-8-F 4P IDC PUR 5M**

Weidmüller Interface GmbH & Co. KG
 Klingenbergstraße 16
 D-32758 Detmold
 Germany
 Fon: +49 5231 14-0
 Fax: +49 5231 14-292083
 www.weidmueller.com

Zeichnungen

Dimensioned drawing

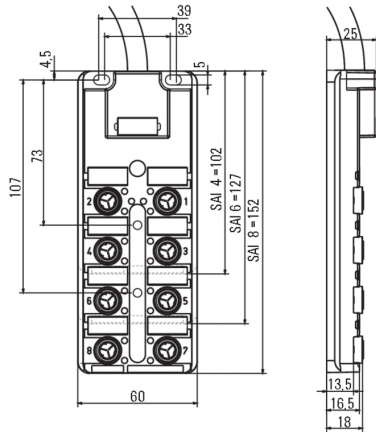

Circuit diagram

