

Operating Instructions

RN42

1-channel active barrier with wide range power supply for the safe separation of 0/4 to 20 mA standard signal circuits, HART-transparent



Table of contents

1	About this document	3	11	Repair	14
1.1	Document function	3	11.1	General information	14
1.2	Symbols	3	11.2	Spare parts	15
1.3	Registered trademarks	4	11.3	Return	15
			11.4	Disposal	15
2	Basic safety instructions	5	12	Technical data	16
2.1	Requirements for the personnel	5	12.1	Function and system design	16
2.2	Intended use	5	12.2	Input	16
2.3	Workplace safety	5	12.3	Output	16
2.4	Operational safety	5	12.4	Power supply	17
2.5	Product safety	6	12.5	Performance characteristics	18
2.6	Installation instructions	6	12.6	Mounting	19
3	Product descriptions	7	12.7	Environment	20
3.1	Product description RN42	7	12.8	Mechanical construction	21
4	Incoming acceptance and product identification	7	12.9	Display and operating elements RN42	22
4.1	Incoming acceptance	7	12.10	Ordering information	22
4.2	Product identification	7	12.11	Accessories	22
4.3	Scope of delivery	8	12.12	Certificates and approvals	23
4.4	Certificates and approvals	8	12.13	Documentation	23
4.5	Storage and transport	9	13	Appendix: system overview of RN Series	25
5	Mounting	9	13.1	Power supply of RN Series	25
5.1	Mounting requirements	9	13.2	Applications of the isolating amplifiers	25
5.2	Installing a DIN rail device	9	Index	29	
5.3	Disassembling the DIN rail device	10			
6	Electrical connection	11			
6.1	Connecting requirements	11			
6.2	Special connection instructions	11			
6.3	Quick wiring guide	12			
6.4	Connecting the supply voltage	12			
6.5	Post-connection check	12			
7	Operation options	13			
7.1	Display and operating elements RN42	13			
8	Commissioning	13			
8.1	Post-installation check	13			
8.2	Switching on the device	13			
9	Diagnostics and troubleshooting ...	14			
9.1	General troubleshooting	14			
10	Maintenance	14			





1 About this document

1.1 Document function













These Operating Instructions contain all the information that is required in various phases of the life cycle of the device: from product identification, incoming acceptance and storage, to mounting, connection, operation and commissioning through to troubleshooting, maintenance and disposal.

1.2 Symbols





1.2.1 Safety symbols

 DANGER This symbol alerts you to a dangerous situation. Failure to avoid this situation will result in serious or fatal injury.	 WARNING This symbol alerts you to a dangerous situation. Failure to avoid this situation can result in serious or fatal injury.
 CAUTION This symbol alerts you to a dangerous situation. Failure to avoid this situation can result in minor or medium injury.	 NOTICE This symbol contains information on procedures and other facts which do not result in personal injury.

1.2.2 Symbols for certain types of information

Symbol	Meaning
	Permitted Procedures, processes or actions that are permitted.
	Preferred Procedures, processes or actions that are preferred.
	Forbidden Procedures, processes or actions that are forbidden.
	Tip Indicates additional information.
	Reference to documentation
	Reference to page
	Reference to graphic
	Notice or individual step to be observed
	Series of steps
	Result of a step
	Help in the event of a problem
	Visual inspection



1.2.3 Electrical symbols

	Direct current		Alternating current
	Direct current and alternating current		Ground connection A grounded terminal which, as far as the operator is concerned, is grounded via a grounding system.

1.2.4 Symbols in graphics

1, 2, 3,...	Item numbers	A, B, C, ...	Views
-------------	--------------	--------------	-------

1.2.5 Symbols at the device

	Warning Observe the safety instructions contained in the associated Operating Instructions
	Equipment protected throughout by DOUBLE INSULATION or REINFORCED INSULATION

1.3 Registered trademarks

HART®

Registered trademark of the FieldComm Group, Austin, Texas, USA

2 Basic safety instructions

2.1 Requirements for the personnel

The personnel for installation, commissioning, diagnostics and maintenance must fulfill the following requirements:

- ▶ Trained, qualified specialists must have a relevant qualification for this specific function and task.
- ▶ Are authorized by the plant owner/operator.
- ▶ Are familiar with federal/national regulations.
- ▶ Before starting work, read and understand the instructions in the manual and supplementary documentation as well as the certificates (depending on the application).
- ▶ Follow instructions and comply with basic conditions.

The operating personnel must fulfill the following requirements:

- ▶ Are instructed and authorized according to the requirements of the task by the facility's owner-operator.
- ▶ Follow the instructions in this manual.

2.2 Intended use

2.2.1 Active barrier

The active barrier is used for the safe isolation of 0/4 to 20 mA standard signal circuits. An intrinsically safe version is optionally available for operation in Zone 2. The device is designed for installation on DIN rails in accordance with IEC 60715.

A use in a manner not specified by the manufacturer's manual may impair the safety.

2.2.2 Product liability

The manufacturer does not accept any responsibility for damage that results from non-designated use and from failure to comply with the instructions in this manual.

2.3 Workplace safety

For work on and with the device:

- ▶ Wear the required personal protective equipment according to federal/national regulations.

2.4 Operational safety

Risk of injury!

- ▶ Operate the device only if it is in proper technical condition, free from errors and faults.
- ▶ The operator is responsible for interference-free operation of the device.

Modifications to the device

Unauthorized modifications to the device are not permitted and can lead to unforeseeable dangers:

- ▶ If modifications are nevertheless required, consult with the manufacturer.

Repair

To ensure continued operational safety and reliability:

- ▶ Carry out repairs on the device only if they are expressly permitted.

- ▶ Observe federal/national regulations pertaining to the repair of an electrical device.
- ▶ Use only original spare parts and accessories from the manufacturer.

Hazardous area

To eliminate danger to persons or the facility when the device is used in the hazardous area (e.g. explosion protection):

- ▶ Check the nameplate to verify if the device ordered can be put to its intended use in the hazardous area.
- ▶ Observe the specifications in the separate supplementary documentation that is an integral part of these instructions.

2.5 Product safety

This device is designed in accordance with good engineering practice to meet state-of-the-art safety requirements, has been tested, and left the factory in a condition in which it is safe to operate.

2.6 Installation instructions

- The device's IP20 degree of protection is intended for a clean and dry environment.
- Do not expose the device to mechanical and/or thermal stress that exceeds the specified limits.
- The device is intended for installation in a cabinet or similar housing. The device may only be operated as an installed device.
- To protect against mechanical or electrical damage, the device must be installed in an appropriate housing with a suitable degree of protection according to IEC/EN 60529.
- The device fulfills the EMC regulations for the industrial sector.

3 Product descriptions

3.1 Product description RN42

3.1.1 Product design

Active barrier, 1-channel

- The active barrier is used for the transmission and galvanic isolation of 0/4 to 20 mA/HART signals. The device has an active/passive current input to which a 2- or 4-wire transmitter can be directly connected. The output of the device can be operated actively or passively. The current signal is then available to the PLC / controller or to other instrumentation at plug-in screw terminals or optional push-in terminals.
- HART communication signals are transmitted bidirectionally by the device. Connection sockets for connecting HART communicators are integrated into the front of the device.
- The device is optionally available as an "associated apparatus", which allows devices to be connected in Ex Zone 0/20 [ia] and operated in Ex Zone 2 [ec]. 2-wire transmitters are supplied with power, and transmit analog 0/4 to 20 mA/HART measured values from the hazardous area to the non-hazardous area. These devices are accompanied by separate Ex documentation, which is an integral part of this manual. Compliance with the installation instructions and connection data in this documentation is mandatory!

4 Incoming acceptance and product identification

4.1 Incoming acceptance

Check the following during incoming acceptance:

- Are the order codes on the delivery note and the product sticker identical?
- Are the goods undamaged?
- Do the data on the nameplate match the ordering information on the delivery note?



If one of these conditions is not met, please contact the manufacturer's sales office.

4.2 Product identification

The following options are available for identification of the device:

- Nameplate specifications
- Extended order code with breakdown of the device features on the delivery note
- Enter the serial number from the nameplate in the *W@M Device Viewer* (www.endress.com/deviceviewer): all data relating to the device and an overview of the Technical Documentation supplied with the device are displayed.
- Enter the serial number on the nameplate into the *Endress+Hauser Operations App* or scan the 2-D matrix code (QR code) on the nameplate with the *Endress+Hauser Operations App*: all the information about the device and the technical documentation pertaining to the device is displayed.

4.2.1 Nameplate

The right device?

Compare and check the data on the nameplate of the device against the requirements of the measuring point:

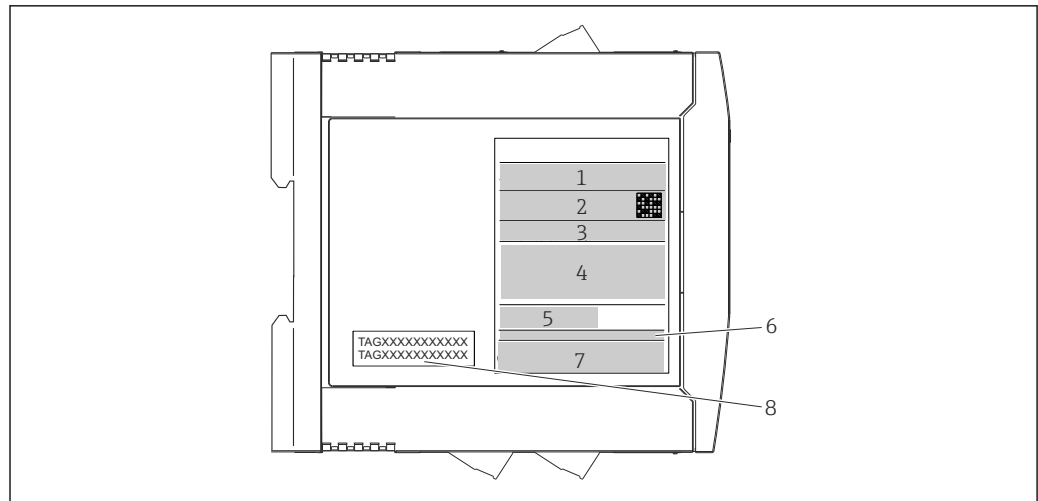

A0041996

1 Nameplate (example of Ex version)

- 1 Product name and manufacturer ID
- 2 Order code, extended order code and serial number, DataMatrix 2D code, FCC-ID (if applicable)
- 3 Power supply and current consumption, output
- 4 Approval in hazardous area with number of the relevant Ex documentation (XA...)
- 5 Fieldbus communication logo
- 6 Firmware version and device revision
- 7 Approval logos
- 8 2 lines for the TAG name

4.2.2 Name and address of manufacturer

Name of manufacturer:	Endress+Hauser Wetzer GmbH + Co. KG
Address of manufacturer:	Obere Wank 1, D-87484 Nesselwang
Model/type reference:	RN42

4.3 Scope of delivery

The scope of delivery comprises:

- Device as per order
- Printed copy of the Brief Operating Instructions
- Optional: Functional safety manual (SIL mode)
- Additional documentation for devices which are suitable for use in the hazardous area (Ex, , ,) , such as Safety Instructions (XA...), Control or Installation Drawings (ZD...)

4.4 Certificates and approvals

i For certificates and approvals valid for the device: see the data on the nameplate

i Approval-related data and documents: www.endress.com/deviceviewer → (enter the serial number)

4.4.1 Functional safety

A SIL version of the device is optionally available. It can be used in safety equipment in accordance with IEC 61508 up to SIL 2 (SC 3) .

📖 Please refer to Safety Manual FY01034K for the use of the device in safety instrumented systems according to IEC 61508.

4.5 Storage and transport

- i** When storing and transporting the device, pack it so that it is reliably protected against impact. The original packaging provides optimum protection.

5 Mounting

5.1 Mounting requirements

5.1.1 Dimensions

The dimensions of the device are provided in the 'Technical data' section of the Operating Instructions.

5.1.2 Mounting location

The device is designed for installation on 35 mm (1.38 in) DIN rails in accordance with IEC 60715 (TH35).

NOTICE

- ▶ When using in hazardous areas, the limit values of the certificates and approvals must be observed.

- i** For information on ambient conditions, see the "Technical data" section.

5.2 Installing a DIN rail device

The device can be installed in any position (horizontal or vertical) on the DIN rail without lateral clearance from neighboring devices. No tools are required for installation. The use of end brackets (type "WEW 35/1" or equivalent) on the DIN rail is recommended to fix the device.

- i** If several devices are installed side by side, it is important to ensure that the maximum side wall temperature of the individual devices of 80 °C (176 °F) is not exceeded. If this cannot be guaranteed, mount the devices at a distance from one another or ensure sufficient cooling.

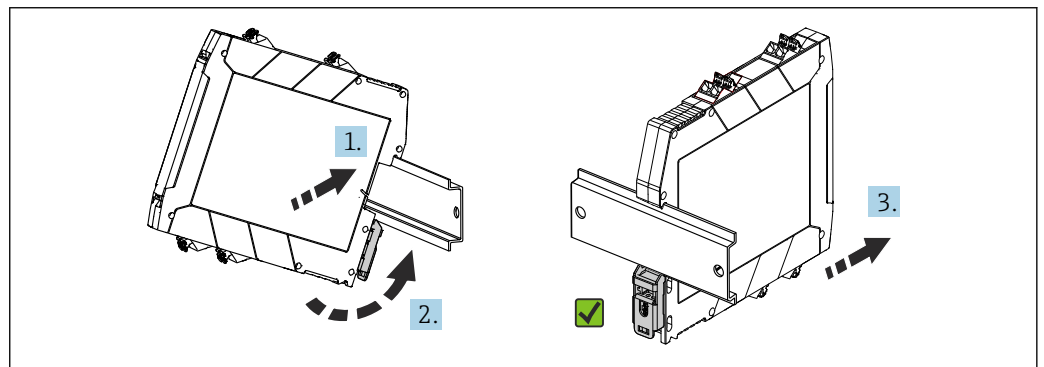

2 Installing on DIN rail

A0041736

1. Position the top DIN rail groove at the top end of the DIN rail.

2. While holding the front of the device horizontally, lower it until you hear the locking clip of the device click into place on the DIN rail.
3. Pull gently on the device to check if it is correctly mounted on the DIN rail.

5.3 Disassembling the DIN rail device

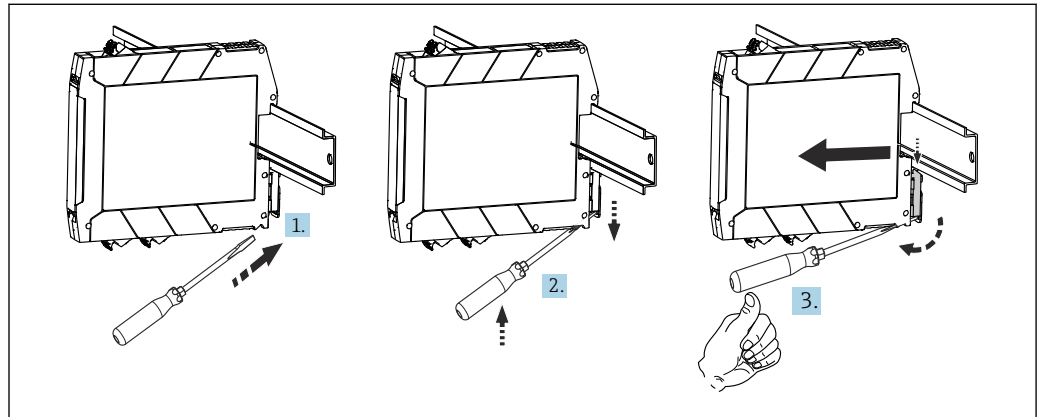

 3 *Disassembling the DIN rail device*

1. Insert a screwdriver into the tab of the DIN rail clip.
2. Use the screwdriver to pull down on the DIN rail clip as shown in the diagram.
3. Hold down the screwdriver to remove the device from the DIN rail.

6 Electrical connection

6.1 Connecting requirements

A flat-blade screwdriver is required to establish an electrical connection to screw or push-in terminals.

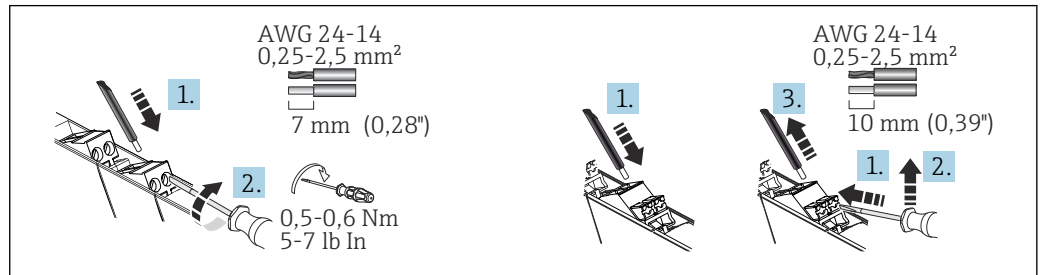

4 Electrical connection using screw terminals (left) and push-in terminals (right)

CAUTION

Destruction of parts of the electronics

- ▶ Switch off the power supply before installing and connecting the device.

NOTICE

Destruction or malfunction of parts of the electronics

- ▶ ⚠ ESD - Electrostatic discharge. Protect the terminals and HART sockets on the front from electrostatic discharge.
- ▶ A shielded cable is recommended for HART communication. Observe grounding concept of the plant.

i For information on the connection data, see the "Technical data" section.

6.2 Special connection instructions

- Disconnecting units and auxiliary circuit protective systems with suitable AC or DC values must be provided within reach in the building installation.
- A switch/power circuit breaker must be provided close to the device and clearly marked as a disconnecting unit for this device.
- A circuit breaker (nominal current ≤ 10 A; breaking capacity 6 kA; e.g. type B) must be provided within reach for the supply line.

i For information on the connection data, see the "Technical data" section.

6.3 Quick wiring guide

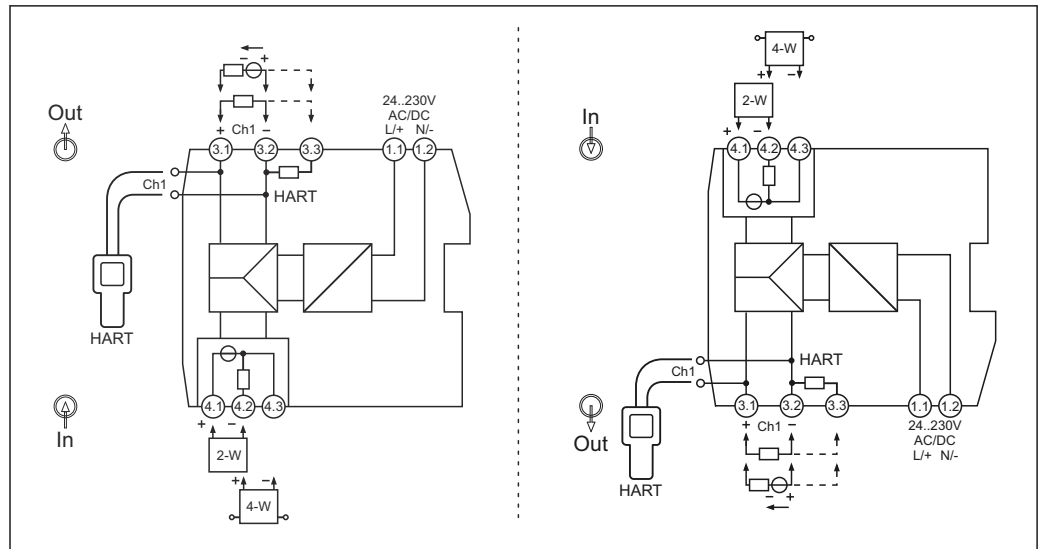

5 Terminal assignment, left: power supply top; right: power supply bottom (option)

i HART communicators can be connected to the HART connection sockets. Ensure an adequate external resistance ($\geq 230 \Omega$) in the output circuit.

To use the HART terminals, the internal 250Ω communication resistor can be added to the measuring loop via the alternative terminal assignment (terminal 3.3).

6.4 Connecting the supply voltage

The power is supplied via terminals 1.1 and 1.2.

6.5 Post-connection check

Device condition and specifications	Notes
Are the device or cables free from damage (visual check)?	--
Do the ambient conditions match the device specification (e.g. ambient temperature, measuring range, etc.)?	See 'Technical data'
Electrical connection	Notes
Does the supply voltage match the specifications on the nameplate?	Active barrier: U = 24 to 230 V
Are the power supply and signal cables connected correctly?	--
Are all the screw terminals well tightened and have the connections of the push-in terminals been checked?	--

7 Operation options

7.1 Display and operating elements RN42

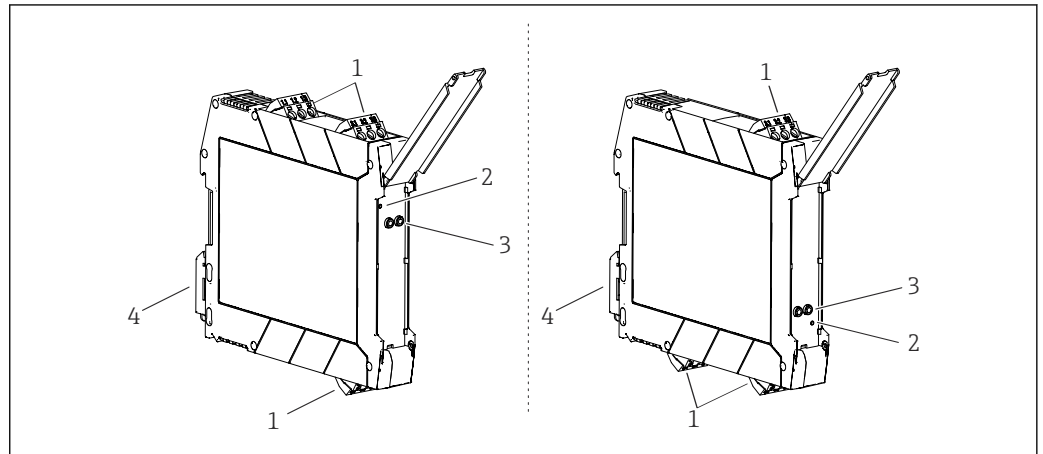

6 Display and operating elements, left: power supply top; right: power supply bottom (option)

- 1 Plug-in screw or push-in terminal
- 2 Green LED "On", power supply
- 3 Connection sockets for HART communication (channel 1)
- 4 DIN rail clip for DIN rail mounting

7.1.1 Local operation

Hardware settings / configuration

No manual hardware settings are required at the device for commissioning.

Attention must be paid to the different terminal assignment when connecting 2/4-wire transmitters. At the output side, the connected system is detected and automatic switching takes place between the active and passive mode.

8 Commissioning

8.1 Post-installation check

Before commissioning the device, ensure that all post-mounting and post-connection checks have been carried out.

NOTICE

- ▶ Before commissioning the device, make sure that the supply voltage matches the voltage specifications on the nameplate. Failure to perform these checks may result in damage to the device caused by the incorrect supply voltage.

8.2 Switching on the device

Switch on the supply voltage. The green LED display on the front of the device indicates that the device is operational.

- i** To prevent incorrect wiring, the output current should be verified when simulating a high alarm at the input.

9 Diagnostics and troubleshooting

9.1 General troubleshooting

Always start troubleshooting with the checklists below if faults occur after startup or during operation. The checklists take you directly (via various queries) to the cause of the problem and the appropriate remedial measures.

 Due to its design, the device cannot be repaired. However, it is possible to send the device in for examination. See the "Return" section.

General faults

Fault	Possible cause	Remedial action
Device does not respond.	Supply voltage does not match the voltage specified on the nameplate.	Check the voltage directly using a voltmeter and correct.
	Connecting cables are not in contact with the terminals.	Ensure electrical contact between the cable and the terminal.
	Electronics module is defective.	Replace the device.
HART communication is not working.	Missing or incorrectly installed communication resistor.	Install the communication resistor (230 Ω) correctly.
	HART modem is not properly connected.	Connect HART modem correctly.
	HART modem is not set to "HART".	Set HART modem selector switch to "HART".
The power LED on the DIN rail device is not lit (green).	Power failure or insufficient supply voltage.	Check the supply voltage and check if wiring is correct.
High-alarm at the input cannot be output at the output.	Output load is too high (max. output load active / passive: see technical data)	Reduce output load.
	Passive mode: external voltage at the output is incorrectly connected.	Connect external voltage correctly to output.

10 Maintenance

No special maintenance work is required for the device.

Cleaning

A clean, dry cloth can be used to clean the device.

11 Repair

11.1 General information

Due to its design, the device cannot be repaired.

11.2 Spare parts

Spare parts currently available for the device can be found online at: http://www.products.endress.com/spareparts_consumables. Always quote the serial number of the device when ordering spare parts!

Type	Order code
Plug-in terminal set, 3-pin, DIN rail interfaces - screw	71505345
Plug-in terminal set, 3-pin, DIN rail interfaces - push-in	71505346
Front cover 17.5 mm, DIN rail housing (5 pcs per pack)	71505348

11.3 Return

The requirements for safe device return can vary depending on the device type and national legislation.

1. Refer to the website for more information:
<http://www.endress.com/support/return-material>
2. Return the device if repairs or a factory calibration are required, or if the wrong device was ordered or delivered.

11.4 Disposal



If required by the Directive 2012/19/EU on waste electrical and electronic equipment (WEEE), the product is marked with the depicted symbol in order to minimize the disposal of WEEE as unsorted municipal waste. Do not dispose of products bearing this marking as unsorted municipal waste. Instead, return them to the manufacturer for disposal under the applicable conditions.

12 Technical data

12.1 Function and system design

Product description RN42

Product design

Active barrier, 1-channel

- The active barrier is used for the transmission and galvanic isolation of 0/4 to 20 mA/HART signals. The device has an active/passive current input to which a 2- or 4-wire transmitter can be directly connected. The output of the device can be operated actively or passively. The current signal is then available to the PLC / controller or to other instrumentation at plug-in screw terminals or optional push-in terminals.
- HART communication signals are transmitted bidirectionally by the device. Connection sockets for connecting HART communicators are integrated into the front of the device.
- The device is optionally available as an "associated apparatus", which allows devices to be connected in Ex Zone 0/20 [ia] and operated in Ex Zone 2 [ec]. 2-wire transmitters are supplied with power, and transmit analog 0/4 to 20 mA/HART measured values from the hazardous area to the non-hazardous area. These devices are accompanied by separate Ex documentation, which is an integral part of this manual. Compliance with the installation instructions and connection data in this documentation is mandatory!

Dependability

We only provide a warranty if the device is installed and used as described in the Operating Instructions.

12.2 Input

Version

The following versions are available:
1-channel

Input data, measuring range

Input signal range (underrange / overrange)	0 to 22 mA
Function range, input signal	0/4 to 20 mA
Input voltage drop signal for 4-wire connection	< 7 V at 20 mA
Transmitter supply voltage	17.5 V ± 1 V at 20 mA Open-circuit voltage: 24.5 V ± 5 %

12.3 Output

Output data

Output signal range (underrange / overrange)	0 to 22 mA
Function range, output signal	0/4 to 20 mA
Transmission behavior	1:1 to input signal
NAMUR NE 43	A current at the input that is valid according to NAMUR NE 43 is transmitted to the output (within the specified measuring uncertainty range)
Maximum load, active mode	≤ 500 Ω
Open-circuit voltage, active mode	17.5 V (± 5%)
Maximum load, passive mode	$R_{max} = (U_{ext} - 4 V) / 0.022 A$

External voltage, passive mode	U _{ext} = 12 to 30 V
Transmissible communication protocols	HART

Signal on alarm	Line break in input	Input 0 mA / output 0 mA
	Line short circuit in input	Input > 22 mA/ output > 22 mA

Ex connection data See associated XA Safety Instructions

Galvanic isolation	Power supply for input/output	Testing voltage: 3 000 V _{AC} 50 Hz, 1 min
--------------------	-------------------------------	---

12.4 Power supply

Terminal assignment

Quick wiring guide

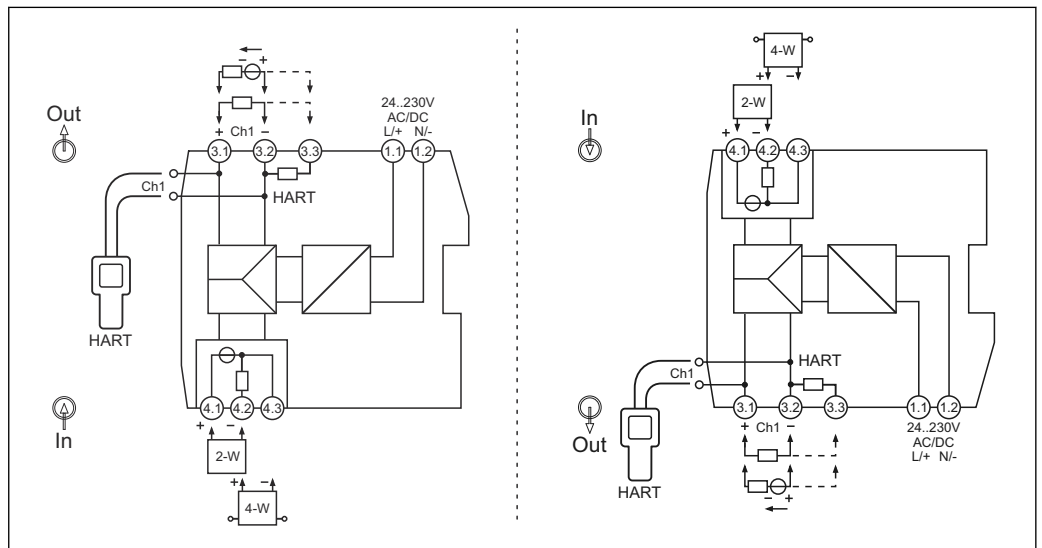

7 Terminal assignment, left: power supply top; right: power supply bottom (option)

i HART communicators can be connected to the HART connection sockets. Ensure an adequate external resistance ($\geq 230 \Omega$) in the output circuit.
 To use the HART terminals, the internal 250Ω communication resistor can be added to the measuring loop via the alternative terminal assignment (terminal 3.3).

Connecting the supply voltage The power is supplied via terminals 1.1 and 1.2.

Special connection instructions

- Disconnecting units and auxiliary circuit protective systems with suitable AC or DC values must be provided in the building installation.
- A switch/power circuit breaker must be provided close to the device and clearly marked as a disconnecting unit for this device.
- An overcurrent protection unit ($I \leq 10 \text{ A}$) must be provided in the installation.

i For information on the connection data, see the "Technical data" section.

Performance characteristics *Power supply*¹⁾

Supply voltage	24 to 230 V _{AC/DC} (-20% / +10%, 0/50/60 Hz)
Power consumption	≤ 4.9 VA / 2.4 W (20 mA); ≤ 5 VA / 2.5 W (22 mA)
Power loss	≤ 2 W (20 mA); ≤ 2.1 W (22 mA)
Current consumption at 24 V _{DC}	≤ 0.1 A (20 mA); ≤ 0.1 A (22 mA)
Current consumption at 230 V _{AC}	≤ 0.02 A (20 mA); ≤ 0.02 A (22 mA)

1) The data apply for the following operating scenario: input active / output active / output load 0 Ω. When external voltages are connected to the output, the power loss in the device may increase. The power loss in the device can be reduced by connecting an external output load.

Terminals

A flat-blade screwdriver is required to establish an electrical connection to screw or push-in terminals.

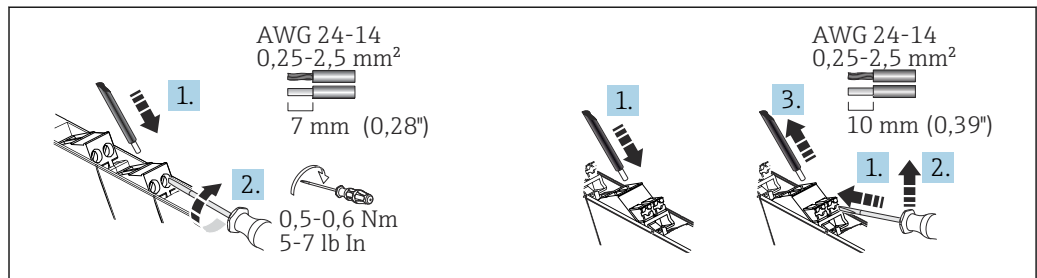

8 Electrical connection using screw terminals (left) and push-in terminals (right)

Terminal design	Cable design	Cable cross-section
Screw terminals Tightening torque: minimum 0.5 Nm/maximum 0.6 Nm	Rigid or flexible (Stripping length = 7 mm (0.28 in))	0.2 to 2.5 mm ² (24 to 14 AWG)
	Flexible with wire end ferrules (with or without plastic ferrule)	0.25 to 2.5 mm ² (24 to 14 AWG)
Push-in spring terminals	Rigid or flexible (Stripping length = 10 mm (0.39 in))	0.2 to 2.5 mm ² (24 to 14 AWG)
	Flexible with wire end ferrules (with or without plastic ferrule)	0.25 to 2.5 mm ² (24 to 14 AWG)

Cable specification

A shielded cable is recommended for HART communication. Observe grounding concept of the plant.

12.5 Performance characteristics

Response time

Step response (10 to 90 %)	≤ 1 ms
----------------------------	--------

Reference operating conditions

- Calibration temperature: +25 °C ±3 K (77 °F ±5.4 °F)
- Supply voltage: 24 V_{DC} / 230 V_{AC}
- Output load: 225 Ω
- External output voltage (passive output): 20 V_{DC}
- Warm-up: > 1 h

Maximum measured error

Accuracies

Transmission error	< 0.1 % / of full scale value (< 20 μ A)
Temperature coefficient	< 0.01 % /K

Long-term drift

Max. ± 0.1 %/year (of full scale value)

12.6 Mounting

Mounting location

The device is designed for installation on 35 mm (1.38 in) DIN rails in accordance with IEC 60715 (TH35).

NOTICE

- ▶ When using in hazardous areas, the limit values of the certificates and approvals must be observed.



For information on ambient conditions, see the "Technical data" section.

Installing a DIN rail device

The device can be installed in any position (horizontal or vertical) on the DIN rail without lateral clearance from neighboring devices. No tools are required for installation. The use of end brackets (type "WEW 35/1" or equivalent) on the DIN rail is recommended to fix the device.



If several devices are installed side by side, it is important to ensure that the maximum side wall temperature of the individual devices of 80 °C (176 °F) is not exceeded. If this cannot be guaranteed, mount the devices at a distance from one another or ensure sufficient cooling.

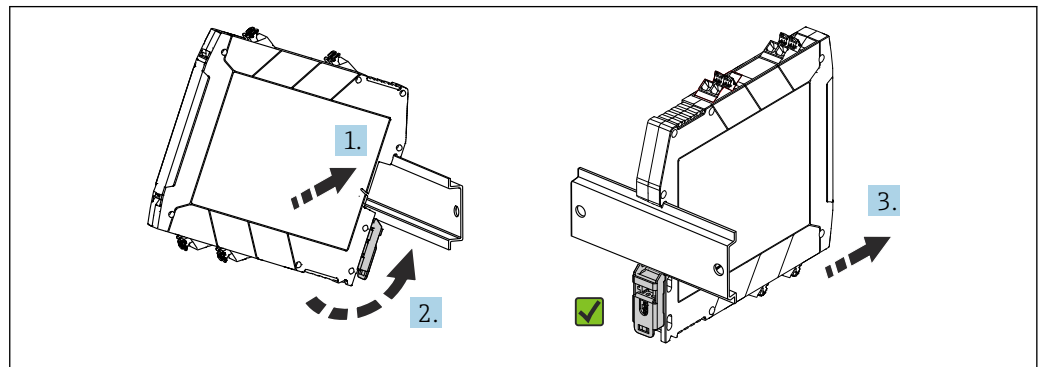

9 Installing on DIN rail

1. Position the top DIN rail groove at the top end of the DIN rail.
2. While holding the front of the device horizontally, lower it until you hear the locking clip of the device click into place on the DIN rail.
3. Pull gently on the device to check if it is correctly mounted on the DIN rail.

12.7 Environment

Important ambient conditions	Ambient temperature range	-40 to 60 °C (-40 to 140 °F)	Storage temperature	-40 to 80 °C (-40 to 176 °F)
	Degree of protection	IP 20	Overvoltage category	II
	Pollution degree	2	Humidity	5 to 95 %
	Operating altitude, hazardous area version	≤ 2 000 m (6 562 ft)	Operating altitude, non-hazardous area version	≤ 4 000 m (13 123 ft)
			Insulation class	Class II

Maximum temperature change rate 0.5 °C/min, no condensation permitted

Shock and vibration resistance Sinusoidal vibrations, in accordance with IEC 60068-2-6

- 5 to 13.2 Hz: 1 mm peak
- 13.2 to 100 Hz: 0.7g peak

Electromagnetic compatibility (EMC) **CE compliance**

Electromagnetic compatibility in accordance with all the relevant requirements of the IEC/EN 61326 series and NAMUR Recommendation EMC (NE21). For details, refer to the Declaration of Conformity.

- Maximum measured error < 1% of measuring range
- Strong, pulse-like EMC interference can result in transient (< 1) deviations in the output signal (≥ ±1 %).
- Interference immunity as per IEC/EN 61326 series, industrial requirements
- Interference emission as per IEC/EN 61326 series (CISPR 11) Group 1 Class A

 This unit is not intended for use in residential environments and cannot guarantee adequate protection of the radio reception in such environments.

12.8 Mechanical construction

Design, dimensions

Dimensions in mm (in)

Terminal housing for mounting on DIN rail

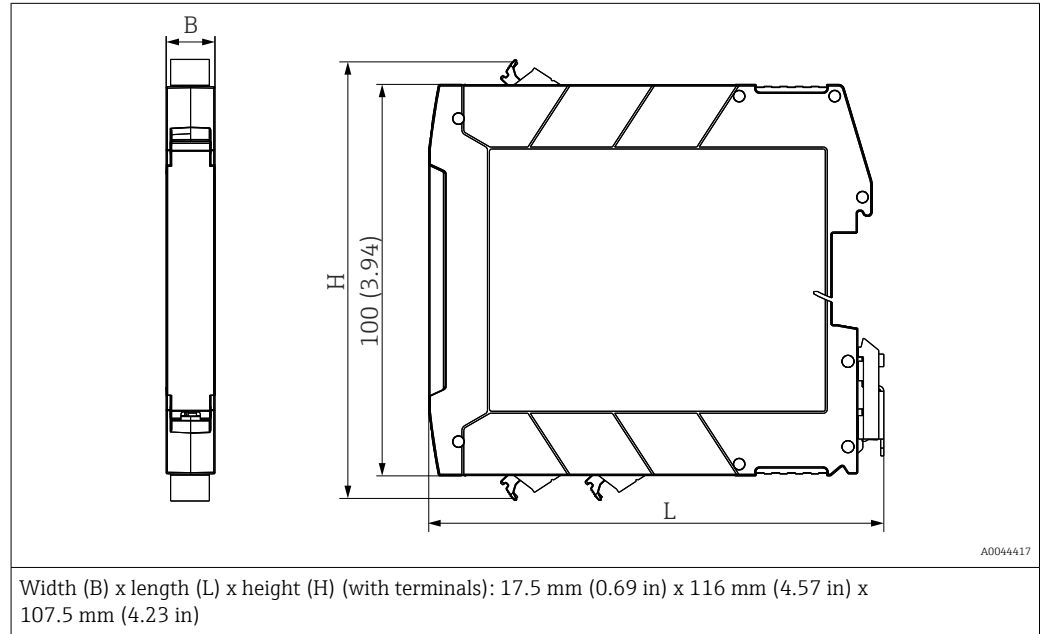

Weight

Device with terminals (values rounded up):
Approx. 135 g (4.76 oz)

Color

Light gray

Materials

All the materials used are RoHS-compliant.
Housing: polycarbonate (PC); flammability rating according to UL94: V-0

12.9 Display and operating elements RN42

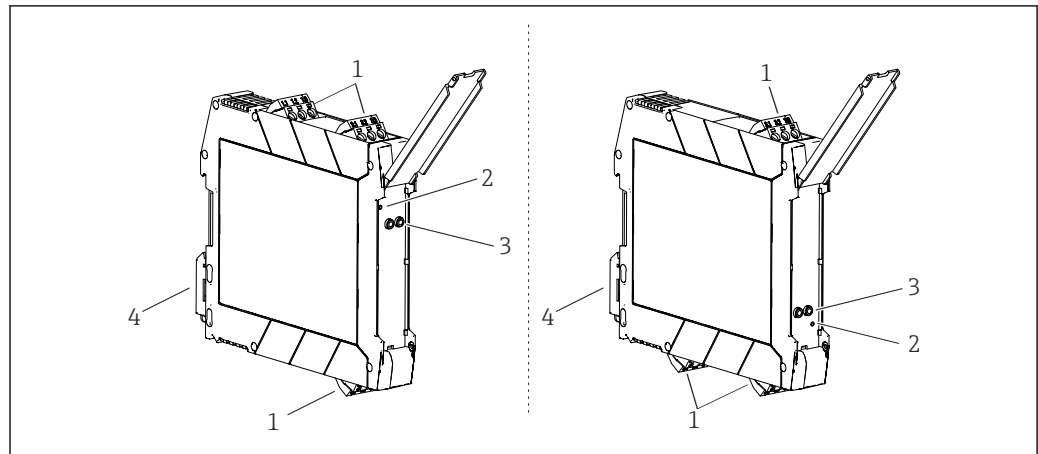

A0045155

 10 Display and operating elements, left: power supply top; right: power supply bottom (option)

- 1 Plug-in screw or push-in terminal
- 2 Green LED "On", power supply
- 3 Connection sockets for HART communication (channel 1)
- 4 DIN rail clip for DIN rail mounting

Local operation

Hardware settings / configuration

No manual hardware settings are required at the device for commissioning.

Attention must be paid to the different terminal assignment when connecting 2/4-wire transmitters. At the output side, the connected system is detected and automatic switching takes place between the active and passive mode.

12.10 Ordering information

Detailed ordering information is available from the nearest sales organization www.addresses.endress.com or in the Product Configurator under www.endress.com:

1. Select the product using the filters and search field.
2. Open the product page.

The **Configuration** button opens the Product Configurator.

Product Configurator - the tool for individual product configuration



- Up-to-the-minute configuration data
- Depending on the device: Direct input of measuring point-specific information such as measuring range or operating language
- Automatic verification of exclusion criteria
- Automatic creation of the order code and its breakdown in PDF or Excel output format
- Ability to order directly in the Endress+Hauser Online Shop

12.11 Accessories

Various accessories, which can be ordered with the device or subsequently from Endress +Hauser, are available for the device. Detailed information on the order code in question is available from your local Endress+Hauser sales center or on the product page of the Endress+Hauser website: www.endress.com.

Accessories	Description
Configurator	<p>Product Configurator - the tool for individual product configuration</p> <ul style="list-style-type: none"> Up-to-the-minute configuration data Depending on the device: Direct input of measuring point-specific information such as measuring range or operating language Automatic verification of exclusion criteria Automatic creation of the order code and its breakdown in PDF or Excel output format Ability to order directly in the Endress+Hauser Online Shop <p>The Configurator is available on the Endress+Hauser website at: www.endress.com -> Click "Corporate" -> Select your country -> Click "Products" -> Select the product using the filters and search field -> Open product page -> The "Configure" button to the right of the product image opens the Product Configurator.</p>
Accessories	Description
W@M	<p>Life cycle management for your plant</p> <p>W@M offers assistance with a wide range of software applications over the entire process: from planning and procurement to the installation, commissioning and operation of the measuring devices. All the relevant information is available for every measuring device over the entire life cycle, such as the device status, device-specific documentation, spare parts etc.</p> <p>The application already contains the data of your Endress+Hauser device. Endress+Hauser also takes care of maintaining and updating the data records.</p> <p>W@M is available: Via the Internet: www.endress.com/lifecyclemanagement</p>

12.12 Certificates and approvals

-  For certificates and approvals valid for the device: see the data on the nameplate
-  Approval-related data and documents: www.endress.com/deviceviewer → (enter the serial number)

Functional safety

A SIL version of the device is optionally available. It can be used in safety equipment in accordance with IEC 61508 up to SIL 2 (SC 3) .

-  Please refer to Safety Manual FY01034K for the use of the device in safety instrumented systems according to IEC 61508.

12.13 Documentation

The following document types are available in the Downloads section of the Endress +Hauser website (www.endress.com/downloads):

-  For an overview of the scope of the associated Technical Documentation, refer to the following:
 - W@M Device Viewer* (www.endress.com/deviceviewer): Enter the serial number from the nameplate
 - Endress+Hauser Operations App*: Enter the serial number from the nameplate or scan the matrix code on the nameplate

Brief Operating Instructions (KA)

Guide that takes you quickly to the 1st measured value

The Brief Operating Instructions contain all the essential information from incoming acceptance to initial commissioning.

Operating Instructions (BA)

Your reference guide

These Operating Instructions contain all the information that is required in various phases of the life cycle of the device: from product identification, incoming acceptance and

storage, to mounting, connection, operation and commissioning through to troubleshooting, maintenance and disposal.

Safety Instructions (XA)

Depending on the approval, the following Safety Instructions (XA) are supplied with the device. They are an integral part of the Operating Instructions.



The nameplate indicates the Safety Instructions (XA) that are relevant to the device.

Supplementary device-
dependent documentation

Additional documents are supplied depending on the device version ordered: Always comply strictly with the instructions in the supplementary documentation. The supplementary documentation is an integral part of the device documentation.

13 Appendix: system overview of RN Series

13.1 Power supply of RN Series

13.1.1 General information on the power supply of Endress+Hauser isolating amplifiers

 Read the information leaflet enclosed in the package of the individual products.

13.1.2 Power supply options of RN4x Series (24 to 230 V)

The RN42 active barrier and RLN42 NAMUR isolating amplifier are available with an extended supply voltage range of 24 to 230 V_{AC/DC}. These modules are powered individually and exclusively via the terminals on the device and are **not** suitable for power supply via the DIN rail bus connector.

13.2 Applications of the isolating amplifiers

This section describes the typical applications of the devices.

These devices perform various functions during signal conditioning:

- Amplification
- Normalization
- Filtering
- Galvanic isolation
- Supply of electrical power to connected sensors
- Line monitoring

The devices for these tasks are collectively known as isolating amplifiers or signal isolators and are available with different functions in the Endress+Hauser RN Series. Different types of signals are conditioned in this context.

13.2.1 Types of signals

Signals are referred to as **analog** signals if they can continuously assume every value between a minimum and maximum value (e.g. 0/4-20 mA) and are therefore also known as "value-continuous" signals. The value range in this interval is huge and is practically infinite in terms of measuring accuracy.

Electrical analog signals are generated with the help of a sensor, for example, which records the states, or changes of state, of physical variables and converts them to an electrical signal.

The following variables are typically measured in system and process engineering using Endress+Hauser measuring devices:

- Temperature
- Pressure
- Level
- Total flow
- Analysis values (e.g. turbidity, conductivity, pH etc.)

These analog signals are evaluated in the controller (PLC) and the signals can be used in a "target device": e.g. for

- Display devices, e.g. level indication via RIA15
- Control unit, e.g. level control
- Actuators, e.g. to fill a tank

A transmitter can also be connected downstream of the sensor. This transmitter converts the analog measured value signal to a standard signal and thereby enables the further processing of the signal with additional standardized, electrical modules. The transmitter can also be integrated in the sensor housing.

Binary signals only assume two values and signal the states "on" or "off" / "1" or "0" with these values. Binary signals are often equated with "digital" signals because digital signals are generally binary encoded.

HART (Highway Addressable Remote Transducer) signals are essentially characterized by the fact that they are operated and used as a complement to classic analog standard signals, in contrast to other digital fieldbus systems. HART therefore does not replace point-to-point wiring but rather enables the integration of smart field devices. The digital signals are modulated onto an analog 4 to 20 mA standard current signal by means of HART modulation in order to transmit digital information in addition to the analog information of the process value.

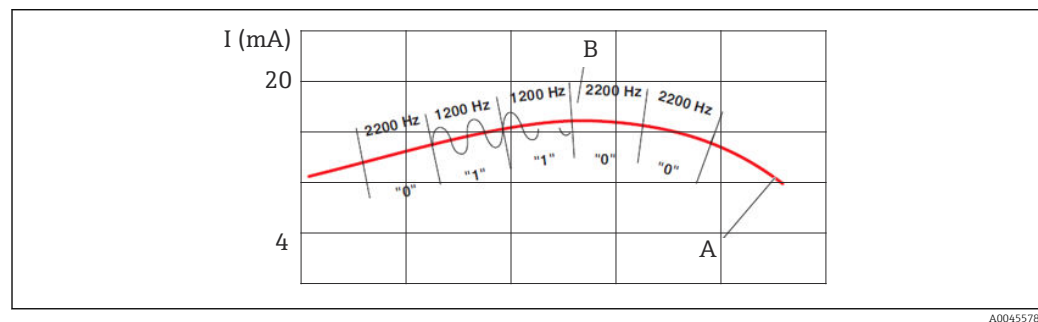

A0045578

11 Modulated HART signal

A Analog signal

B Digital signal

NAMUR sensors are operated with a transmitted current and have four states so that sensor errors can also be detected by an analog evaluation unit. This is sometimes referred to as the "closed circuit current principle".

NAMUR sensors can adopt four states at the output:

- Current 0 mA: wire break; circuit open
- Current <1.2 mA: sensor ready, undamped
- Current >2.1 mA: sensor ready, dampened
- Current maximum value >6 mA: short-circuit, maximum current

The portfolio of the RN Series offers the following function modules:

- RN22, RN42 active barrier
- RN22 signal doubler
- RLN22, RLN42 NAMUR isolating amplifier
- RNO22 output isolating amplifier

13.2.2 RN42 active barrier

The active barriers perform several functions. In addition to galvanic signal isolation and the proportional transmission of analog 0/4-20 mA signals, they also provide power to connected sensors. The RN42 devices are HART-transparent, i.e. they also transmit the HART information supplied by the PMP71B. Via the HART connections on the front, HART signals can be measured or connected "SMART" sensors can be easily configured.

The following are examples of typical applications of the RN42 active barrier. Each application is explained briefly and described in a schematic diagram.

Example: pressure measurement in a hazardous area

- The PMP71B passive 2-wire sensor supplies a current signal proportional to the pressure to the active input of the RN42 active barrier
- The RN42 active barrier supplies an active current output signal proportional to the input signal to a passive input of the evaluation unit

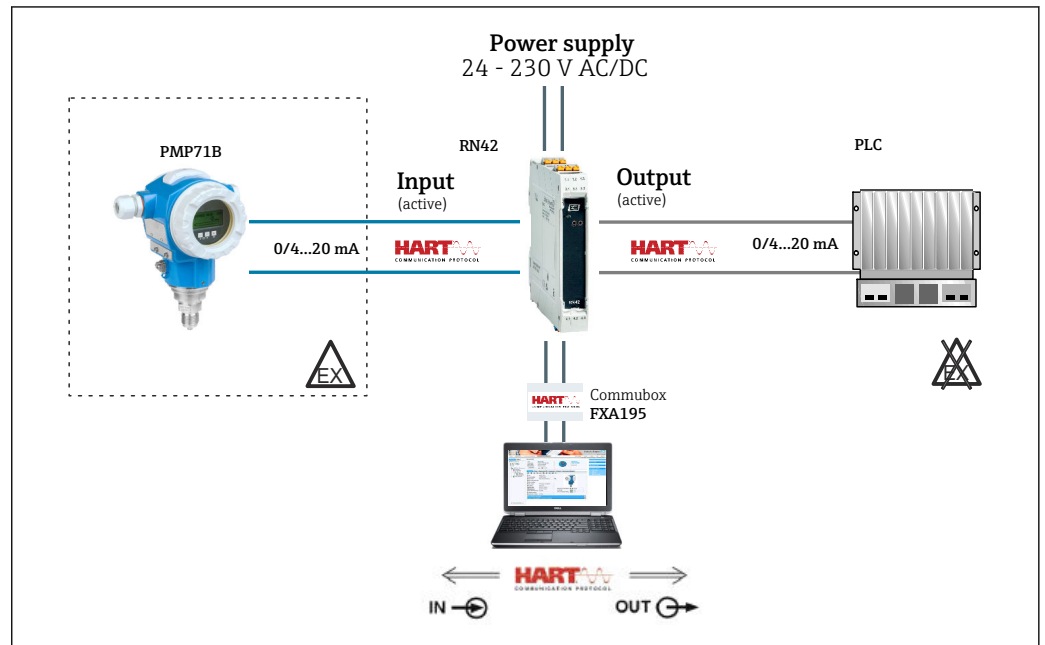

A0045917

12 Pressure measurement in a hazardous area with an RN42 active barrier

Please note: the devices have an active and passive current input to which a 2-wire or 4-wire transmitter can be directly connected. The output of the device can be operated actively or passively. The current signal is then available to the PLC / controller or to other instrumentation.

Flow measurement in a hazardous area

- The Promag P300 active 4-wire sensor supplies a current signal proportional to the flow to the passive input of the RN42 active barrier
- The RN42 active barrier supplies a passive current output signal proportional to the input signal to an active input of the evaluation unit

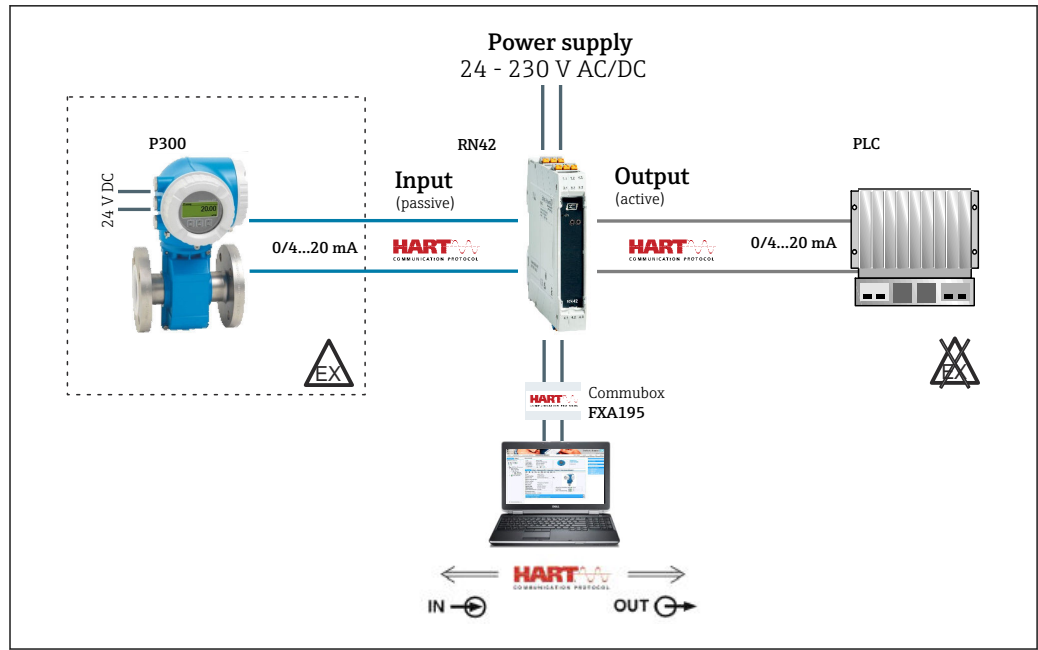

A0045918

13 Flow measurement in the hazardous area with an RN42 active barrier

Index

C

CE mark 6

D

Declaration of Conformity 6

Device documentation

 Supplementary documentation 24

Display and operating elements

 Overview 13, 22

Document

 Function 3

Document function 3

N

Nameplate 7

O

Operation options

 Local operation 13, 22

Operational safety 5

P

Product safety 6

R

Requirements for personnel 5

Return 15

S

Safety Instructions (XA) 24

T

Terminal assignment 12, 17

Troubleshooting

 General faults 14

W

Workplace safety 5



www.addresses.endress.com
