



MB-Power-cable IP67 for connecting the Multiblock, 3 m , prefabricated with 7/8" plug and 7/8" socket



Part no. SWD4-3LR4P-2R
Catalog No. 183223
Eaton Catalog No. SWD4-3LR4P-2R

Similar to illustration

Delivery program

Product range		SmartWire-DT accessories
Basic function		Supply cable
Function		For directly connecting the power supply to EU6E., EU8E.. IP67 SmartWire-DT modules
Description		4 pole Prefabricated with 7/8" right-angle plug and 7/8" right-angle socket
Length	m	3
Note regarding length		1 off
Connection to SmartWire-DT		yes
Protection type (IEC/EN 60529, EN50178, VBG 4)		IP67

Technical data

Ambient conditions, mechanical

Protection type (IEC/EN 60529, EN50178, VBG 4)		IP67
--	--	------

Climatic environmental conditions

Operating ambient temperature (IEC 60068-2)	°C	
Operating ambient temperature max.	°C	+ 70
Condensation		permissible

Design verification as per IEC/EN 61439

Technical data for design verification			
Static heat dissipation, non-current-dependent	P_{vs}	W	0
Heat dissipation capacity	P_{diss}	W	0
Operating ambient temperature max.		°C	-25
Operating ambient temperature max.		°C	70
Degree of Protection			IP67
IEC/EN 61439 design verification			
10.2 Strength of materials and parts			
10.2.2 Corrosion resistance			Meets the product standard's requirements.
10.2.3.1 Verification of thermal stability of enclosures			Meets the product standard's requirements.
10.2.3.2 Verification of resistance of insulating materials to normal heat			Meets the product standard's requirements.
10.2.3.3 Verification of resistance of insulating materials to abnormal heat and fire due to internal electric effects			Meets the product standard's requirements.
10.2.4 Resistance to ultra-violet (UV) radiation			Meets the product standard's requirements.
10.2.5 Lifting			Does not apply, since the entire switchgear needs to be evaluated.
10.2.6 Mechanical impact			Does not apply, since the entire switchgear needs to be evaluated.
10.2.7 Inscriptions			Meets the product standard's requirements.
10.3 Degree of protection of ASSEMBLIES			Meets the product standard's requirements.
10.4 Clearances and creepage distances			Meets the product standard's requirements.
10.5 Protection against electric shock			Does not apply, since the entire switchgear needs to be evaluated.
10.6 Incorporation of switching devices and components			Does not apply, since the entire switchgear needs to be evaluated.
10.7 Internal electrical circuits and connections			Is the panel builder's responsibility.
10.8 Connections for external conductors			Is the panel builder's responsibility.
10.9 Insulation properties			
10.9.2 Power-frequency electric strength			Is the panel builder's responsibility.
10.9.3 Impulse withstand voltage			Is the panel builder's responsibility.
10.9.4 Testing of enclosures made of insulating material			Is the panel builder's responsibility.

10.10 Temperature rise		The panel builder is responsible for the temperature rise calculation. Eaton will provide heat dissipation data for the devices.
10.11 Short-circuit rating		Is the panel builder's responsibility.
10.12 Electromagnetic compatibility		Is the panel builder's responsibility.
10.13 Mechanical function		The device meets the requirements, provided the information in the instruction leaflet (IL) is observed.

Technical data ETIM 6.0

Cables and wires unpreassembled (EG000001) / Data cable (EC000830)

Electric engineering, automation, process control engineering / Cable, wire / Communication cable / Data cable (ecl@ss8.1-27-06-18-01 [AKE197011])

Conductor material		Cu, bare
Diameter conductor	mm	1.5
Nominal cross section conductor	mm ²	0.5
AWG-size		20
Conductor category		Class 2 = stranded
Number of cores		4
Stranding element		Pairs
Core insulation		PE (polyethylene)
Core identification		Colour
Screen over stranding element		Foil
Screen over stranding		None
Material outer sheath		PVC
Colour outer sheath		Black
Halogen free (acc. EN 60754-1/2)		Yes
Flame retardant		In accordance with EN 60332-1-2
Low smoke (acc. EN 61034-2)		No
Outer diameter approx.	mm	11
Permitted cable outer temperature, in movement	°C	-10 - 80
Permitted cable outer temperature, fixed	°C	-20 - 80
Category		-
NVP value	%	66.5

Approvals

North America Certification		UL listed, CSA certified
Specially designed for North America		No

Dimensions

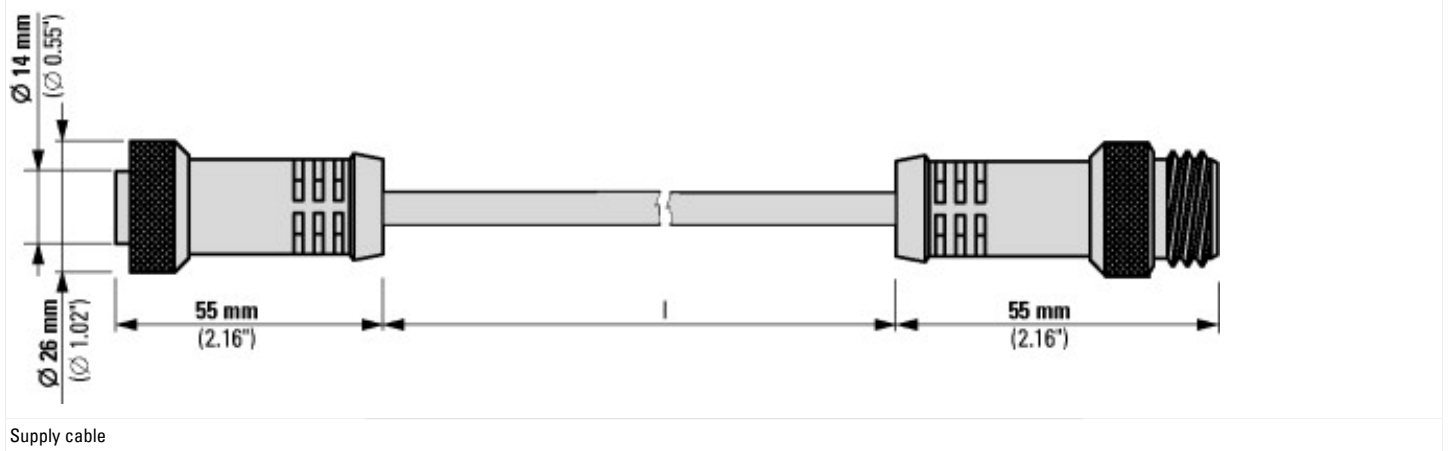

Additional product information (links)

SmartWire-DT product range catalog	http://ecat.moeller.net/flip-cat/?edition=SWKAT&startpage=Titel
------------------------------------	---