

E12588

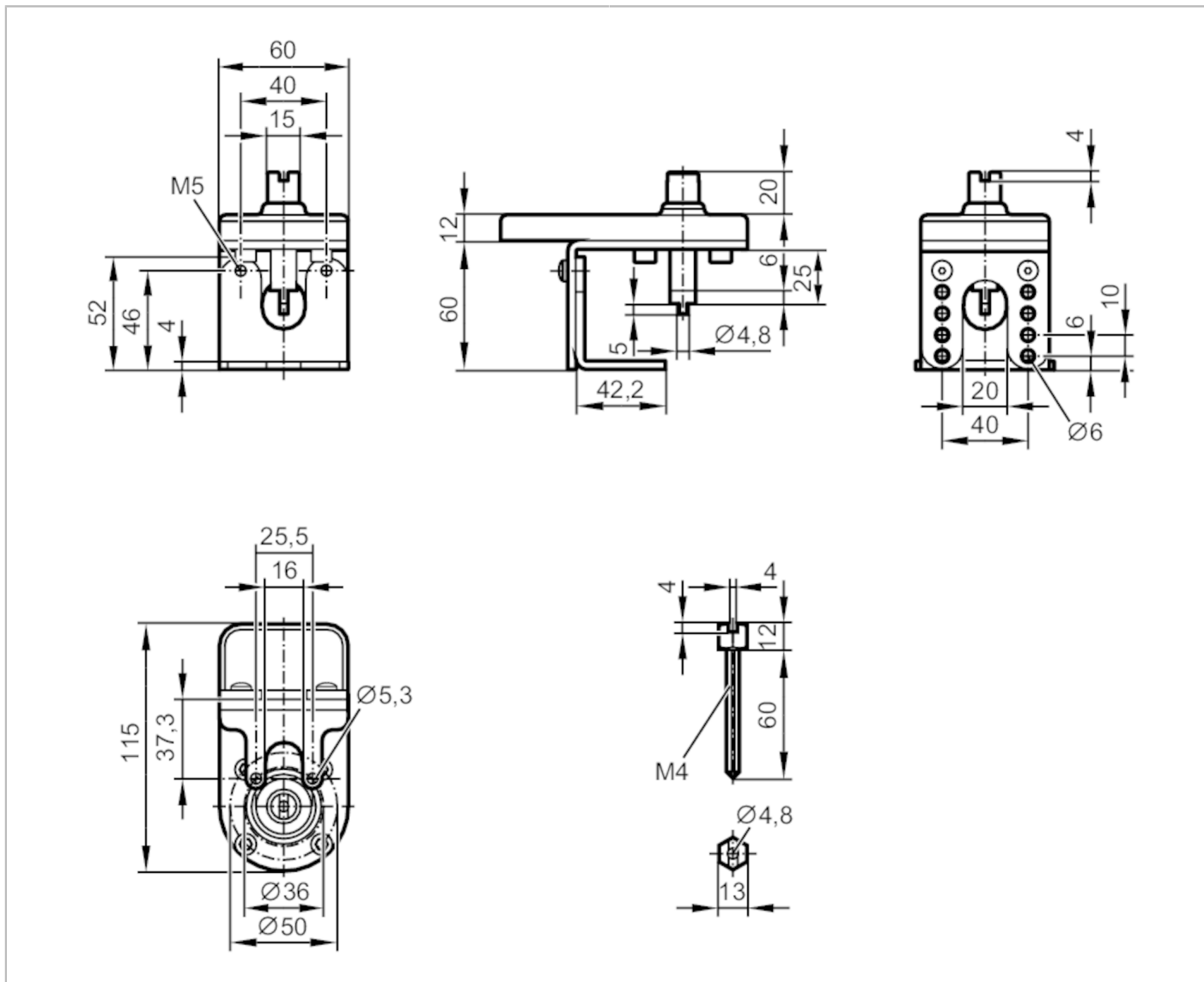

Mounting set for manual valves and ball valves

MOUNTING KIT FOR MANUAL VALVES F03/M4



Application	
Design	for types IND, INE
Operating conditions	
Ambient temperature	[°C] -30...80
Mechanical data	
Weight	[g] 459
Top flange diameter	[mm] 36
ISO top flange type	F03
Shaft extension	M4
Materials	Mounting plate: plastics; metal parts: stainless steel (1.4301 / 304)
Remarks	
Pack quantity	1 pcs.