

TA2303

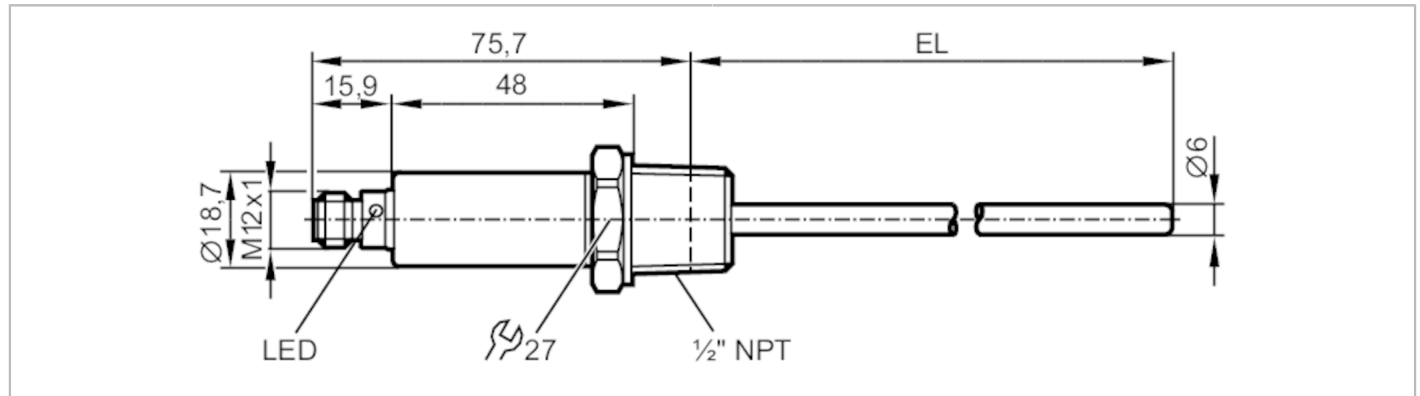

Temperature transmitter

TA-030FLEN12-A-ZVG/US



Product characteristics	
Number of inputs and outputs	Number of analogue outputs: 1
Measuring range [°F]	-58...302
Process connection	threaded connection 1/2" NPT
Installation length EL [mm]	30
Application	
Special feature	Gold-plated contacts
Measuring element	1 x Pt 1000; (to DIN EN 60751, class A)
Media	liquids and gases
Pressure rating [bar]	400
Note on pressure rating	sensor
MAWP (for applications according to CRN) [bar]	When mounted in adapters the specifications of the adapter data sheet apply. 350
Electrical data	
Operating voltage [V]	18...32 DC; ("supply class 2" to cULus)
Current consumption [mA]	< 50
Protection class	III
Reverse polarity protection	yes
Power-on delay time [s]	1
Inputs / outputs	
Number of inputs and outputs	Number of analogue outputs: 1
Outputs	
Total number of outputs	1
Output signal	analogue signal; IO-Link; (configurable)
Number of analogue outputs	1
Analogue current output [mA]	4...20
Max. load [Ω]	250; ((18...19 V); 19...32 V: 300 Ω)
Short-circuit protection	yes
Overload protection	yes

TA2303



Temperature transmitter

TA-030FLEN12-A-ZVG/US

Measuring/setting range		
Measuring range	[°F]	-58...302
Factory setting		0...300 °F
Resolution		
Resolution of analogue output	[K]	0.04
Accuracy / deviations		
Precision analogue output	[K]	± 0,3 + (± 0,1 % MS)
Temperature coefficient [% of the span / 10 K]		0,1; (in case of deviation from the reference condition 25 ± 5 °C)
Response times		
Dynamic response T05 / T09	[s]	1 / 3
Interfaces		
Communication interface		IO-Link
Transmission type		COM2 (38,4 kBaud)
IO-Link revision		1.1
Operating conditions		
Ambient temperature	[°C]	-25...80
Storage temperature	[°C]	-40...100
Protection		IP 67; IP 68; IP 69K
Tests / approvals		
EMC		DIN EN 61000-6-2
Shock resistance		DIN IEC 68-2-27
Vibration resistance		DIN IEC 68-2-6
MTTF	[years]	572
UL approval		UL Approval no. K002
Mechanical data		
Weight	[g]	129.5
Dimensions	[mm]	Ø 18.7
Materials		stainless steel (1.4404 / 316L); PEI; FKM
Materials (wetted parts)		stainless steel (1.4404 / 316L)
Process connection		threaded connection 1/2" NPT
Probe diameter	[mm]	6
Installation length EL	[mm]	30
Displays / operating elements		
Display	operating status	1 x LED, green
Remarks		
Remarks		MS = set measuring span
Pack quantity		1 pcs.
Electrical connection		

Connector: 1 x M12; Contacts: gold-plated

TA2303



Temperature transmitter

TA-030FLEN12-A-ZVG/US



Connection

