

MAX17526A Evaluation Kit

Evaluates: MAX17526A – 5.5V to 60V, 6A Current Limiter with OV, UV, Reverse Protection, and Power Limit

General Description

The MAX17526A evaluation kit (EV kit) is a fully assembled and tested circuit board that demonstrates the MAX17526A high accuracy adjustable power limiter in a 20-pin TQFN-EP package. The EV kit can be configured to demonstrate adjustable overvoltage, undervoltage, overcurrent, different current-limit types, and power limit features.

Features

- 5.5V to 60V Wide Input Voltage Range
- Features a TVS Diode across the Input and Schottky Diode across the Output Terminals
- External NMOSFET Installed
- Evaluates UVLO, OVLO, Three Current-Limit Types, and Current-Limit Threshold
- Programmable Input Overvoltage Setting up to 40V
- Demonstrates Internal UVLO programmed to 12.8V
- Demonstrates Internal OVLO programmed to 36.2V
- Active Power Limit to Protect Supply or Load
- Proven PCB Layout
- Fully Assembled and Tested

Ordering Information appears at end of data sheet.

Quick Start

Recommended Equipment

- MAX17526A EV kit
- 60V DC power supply
- Multimeters
- Adjustable load (0A to 10A)
- 5V DC power supply

Equipment Setup and Test Procedure

The EV kit is fully assembled and tested. Follow the steps below to verify board operation. **Caution: Do not turn on the power supply until all connections are completed.**

- 1) Verify that all jumpers are in their default positions.
- 2) Connect a 5V DC power supply to V_{IO} (TP21).
- 3) Set the 40V DC power supply to 10V and connect it between V_{SN} (TP1/TP2) and GND (TP3/TP4). Verify that LED1 is on and \overline{FLAG} (TP15) is 0V.
- 4) Increase the DC power-supply voltage and verify that LED2 turns on when voltage reaches approximately 12.8V. Also check that voltage on V_{OUT} (TP5/TP6) is 12.8V and \overline{FLAG} is 5V.
- 5) Gradually increase the DC power-supply voltage and verify that LED2 turns off when voltage reaches approximately 36.2V. Also check that voltage on V_{OUT} goes down and \overline{FLAG} is 0V.
- 6) Gradually decrease the DC power-supply voltage and verify that LED2 turns on when voltage reaches approximately 34.1V. Also check that voltage on V_{OUT} is 34.1V and \overline{FLAG} is 5V.
- 7) Set the DC power-supply voltage to 24V and connect the adjustable load between V_{OUT} and GND terminals and a multimeter in series to measure the current. Gradually increase the load current and verify that the V_{OUT} goes down and \overline{FLAG} goes low when the load current increases above 6A.
- 8) The jumpers JU7-JU10 can be configured to change the current-limit as in [Table 7](#). Verify various current-limit operations by repeating step 7.

MAX17526A Evaluation Kit

Evaluates: MAX17526A – 5.5V to 60V, 6A Current Limiter with OV, UV, Reverse Protection, and Power Limit

Detailed Description

The EV kit circuit can be configured to evaluate user-defined UVLO and OVLO thresholds using resistor-dividers. The overcurrent threshold is determined by external resistors connected to the SETI pin and is jumper-configurable through jumpers JU7-JU10. Using jumper JU2, the EV kit circuit can be configured to evaluate different current-limit types (Autoretry, Continuous, and Latch-off). The EV kit also features LEDs to indicate the presence of input and output voltages (see [Table 1](#)).

Input Power Supply

The EV kit is powered by a user-supplied 5.5V to 60V power supply connected between TP1/TP2 (V_{SN}) and GND.

Enable Inputs

Use jumpers JU1 and JU12 to enable the device (see [Table 2](#) for jumper settings and [Table 3](#) for enable switch status).

UVLO/OVLO Threshold

Use jumpers JU3 and JU5 to select internal or external OVLO threshold. Install a shunt on either JU3 or JU5. See [Table 4](#) for jumper settings.

Table 1. LED Indicator (LED1, LED2)

LED	DESCRIPTION
LED1	LED1 is on when SN is powered
LED2	LED2 is on when OUT is powered

Table 2. Enable Inputs Jumper Setting (JU1, JU12)

JUMPER	SHUNT POSITION	DESCRIPTION
JU1	1-2	$\overline{\text{HVEN}}$ pin connected to V _{SN}
	2-3*	$\overline{\text{HVEN}}$ pin connected to GND
JU12	Installed	EN is high
	Not Installed*	EN is low

*Default Position

The external OVLO threshold for input voltage is set through either R2/R3 or R6 resistive divider. Use the following equation to calculate the value of R2 for a required OVLO threshold level:

$$R3 = \frac{R2}{\left(\frac{V_{OVLO}}{V_{SET_OVLO}} - 1\right)}$$

where:

R2 can be chosen as 2.2MΩ

V_{SET_OVLO} = 1.22V

V_{OVLO} = Required overvoltage protection threshold

Use jumpers JU4 and JU6 to select internal or external UVLO threshold. Install a shunt on either JU4 or JU6. See [Table 5](#) for jumper settings.

The external UVLO threshold for input voltage is set through either R4/R5 or R7 resistive divider. Use the following equation to calculate the value of R4 for a required UVLO threshold level:

$$R4 = \frac{R5}{\left(\frac{V_{UVLO}}{V_{SET_UVLO}} - 1\right)}$$

where:

R5 can be chosen as 2.2MΩ

V_{SET_UVLO} = 1.26V

V_{UVLO} = Required undervoltage protection threshold

Table 3. Enable Inputs Switch Status

$\overline{\text{HVEN}}$	EN	MAX17526A STATUS
0	0	ON
0	1	ON
1	0	OFF
1	1	ON

Power Limit Threshold

The EV kit features jumpers (JU13-JU14) to use different power limit thresholds. Install jumpers as shown in [Table 6](#) to change the power-limit threshold. Refer to the MAX17526A data sheet to program PLIM using R21 and R22 (or R16 resistive divider).

Current-Limit Threshold

The EV kit features jumpers (JU7-JU10) to use different resistors to program the current-limit threshold. Install a jumper as shown in [Table 7](#) to change the current-limit threshold.

Current-Limit Type Select

The EV kit features jumper JU2 to select different current-limit responses. See [Table 8](#) for jumper settings.

Table 4. OVLO Threshold Jumper Setting (JU3, JU5)

JUMPER	SHUNT POSITION	DESCRIPTION
JU3	Installed*	OVLO is connected to ground; internal OVLO threshold is used (do not install JU5).
	Not Installed	OVLO is programmable
JU5	1-2	OVLO is connected to V_{SN} with external voltage-divider; use either R2/R3 or R6 to set overvoltage threshold (do not install JU3).
	2-3	OVLO is connected to V_{IN} with an external voltage-divider; use either R2/R3 or R6 to set overvoltage threshold (do not install JU3).
	Not Installed*	Internal OVLO is selected through JU3

*Default Position

Table 5. UVLO Threshold Jumper Setting (JU4, JU6)

JUMPER	SHUNT POSITION	DESCRIPTION
JU4	Installed*	UVLO is connected to ground; internal UVLO threshold is used (do not install JU6).
	Not Installed	UVLO is programmable
JU6	1-2	UVLO is connected to V_{SN} with external voltage-divider; use either R4/R5 or R7 to set overvoltage threshold (do not install JU4).
	2-3	UVLO is connected to V_{IN} with external voltage-divider; use either R4/R5 or R7 to set overvoltage threshold (do not install JU4).
	Not Installed*	Internal UVLO is selected through JU4

*Default Position

Table 6. PLIM Threshold Jumper Setting (JU13, JU14)

JUMPER	SHUNT POSITION	DESCRIPTION
JU13	Installed*	PLIM is connected to ground; PLIM is disabled (do not install JU14).
	Not Installed	PLIM is programmable
JU14	1-2	PLIM is connected to V_{OUT} with external voltage-divider; Use either R21/R22 or R16 to set PLIM threshold (do not install JU13).
	2-3	PLIM is connected to V_{IN} with external voltage-divider; Use either R21/R22 or R16 to set PLIM threshold (do not install JU13).
	Not Installed*	PLIM is disabled

*Default Position

Table 7. Current-Limit Threshold (JU7-JU10)

JUMPER	SHUNT POSITION	DESCRIPTION
JU7	Installed*	Current-limit 0.6A
	Not Installed	SETI open. Part is disabled.
JU8	Installed	Current-limit 2.9A
	Not Installed*	SETI open. Part is disabled.
JU9	Installed	Current-limit 6.0A
	Not Installed*	SETI open. Part is disabled.
JU10	Installed	Current-limit adjustable
	Not Installed*	SETI open. Part is disabled

*Default Position

Table 8. Current-Limit Type Select (JU2)

JUMPER	SHUNT POSITION	DESCRIPTION
JU2	1-2*	Autoretry
	2-3	Latch-off
	Open	Continuous

*Default Position

MAX17526A EV Kit Performance Report

($V_{IN} = 24V$, unless otherwise noted.)

POWER-UP RESPONSE WITH 2200 μ F CAPACITOR AT NO LOAD toc01

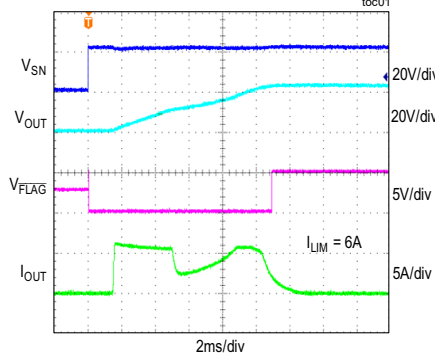

REVERSE-BLOCKING RESPONSE toc02

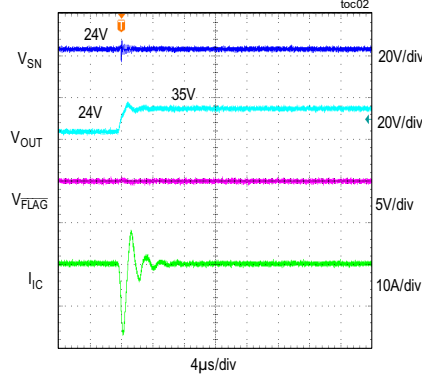

THERMAL FOLDBACK DUE TO OUTPUT SHORT-CIRCUIT toc03

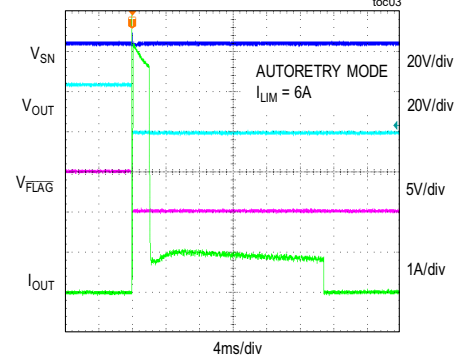

OUTPUT SHORT-CIRCUIT RESPONSE toc04

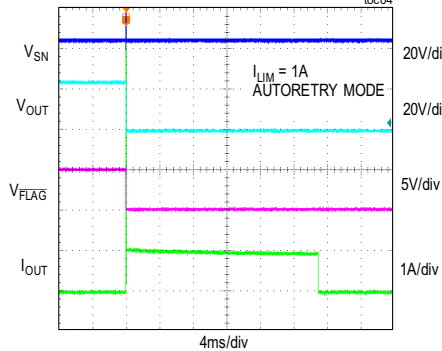

CURRENT-LIMIT RESPONSE toc05

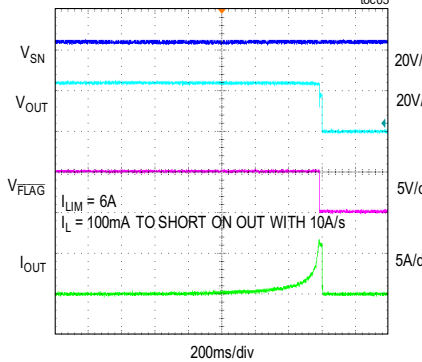

AUTORETRY CURRENT-LIMIT RESPONSE toc06

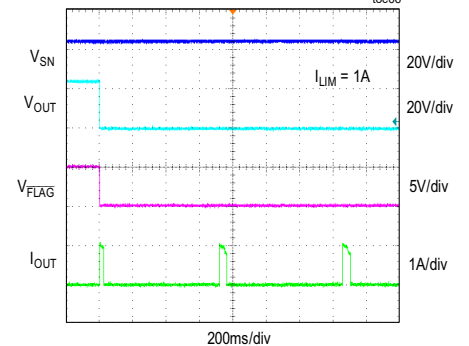

CONTINUOUS CURRENT-LIMIT RESPONSE toc07

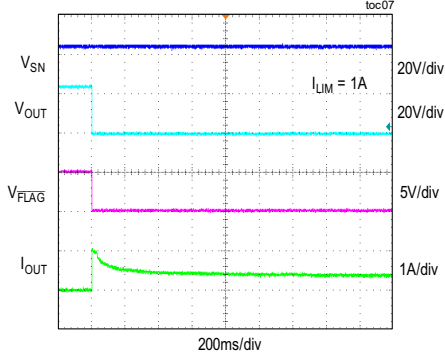

LATCH-OFF CURRENT-LIMIT RESPONSE toc08

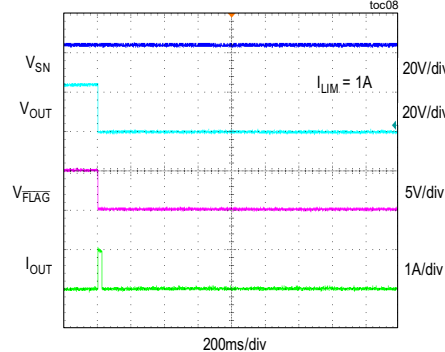

MAX17526A EV Kit Performance Report (continued)

(V_{IN} = 24V, unless otherwise noted.)

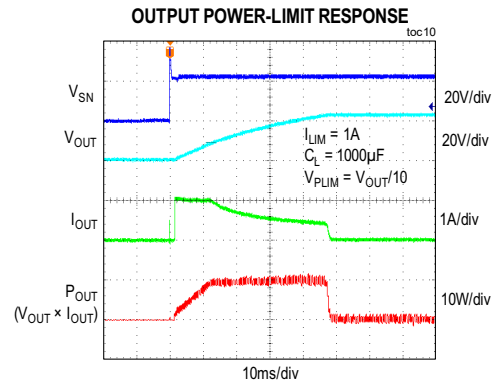
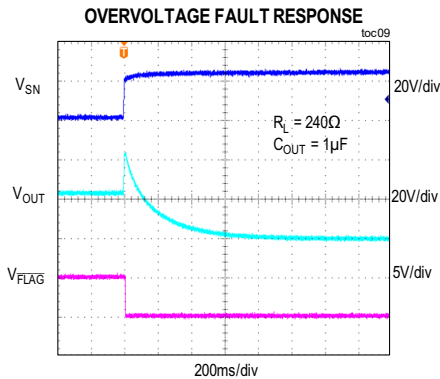

Component Suppliers

SUPPLIER	WEBSITE
Bourns, Inc.	www.bourns.com
Infineon	www.infineon.com
Lite-On, Inc.	www.us.liteon.com
Lumex Inc.	www.lumex.com
Murata Americas	www.murata.com
Panasonic Corp.	www.panasonic.com
TDK Corp.	www.component.tdk.com
ON Semiconductor	www.onsemi.com
SullinsCorp Connector Solutions	www.sullinscorp.com
Keystone Electronics Corp	www.keyelco.com

Note: Indicate that you are using the MAX17526A when contacting these component suppliers.

Ordering Information

PART	TYPE
MAX17526AEVKIT#	EV Kit

MAX17526A Evaluation Kit

Evaluates: MAX17526A – 5.5V to 60V, 6A
Current Limiter with OV, UV, Reverse
Protection, and Power Limit

MAX17526A EV System Bill of Materials

PART REFERENCE	QTY	DESCRIPTION	MANUFACTURER PART NUMBER
C1, C5	2	1µF 10%, 100V X7R ceramic capacitors (1206)	Murata GRM31CR72A105KA01L; TDK C3216X7R2A105K160
C2, C4	2	10µF 20%, 63V aluminium electrolytic (5mm)	Panasonic ECA-1JHG100
C3	1	1µF 10%, 6.3V X7R ceramic capacitors (0603)	Murata GRM188R60J105KA01
D1	1	Power Schottky Diode, 50V, 1A (SMA)	ON Semiconductor MURA105T3G
D2	1	TVS Diode, 1500W (SMC)	Generic Part SMCJ36CA
JU1, JU2, JU5, JU6, JU14	5	3-Pin Single-Row Header, 0.1in centers, cut to fit	Sullins Connector PEC03SAAN
JU3, JU4, JU7-JU10, JU12, JU13	8	2-Pin Single-Row Header, 0.1in centers, cut to fit	Sullins Connector PEC02SAAN
LED1	1	Green LED (1206)	Lumex Optocomponents SML-LX1206GW-TR
LED2	1	Yellow LED (1206)	Lite-On Electronics LTST-C150KSKT
Q1	1	N-CH MOSFET 100V 40A	Infineon BSZ150N10LS3 G
R1, R15	2	220k ohm 1% resistors (0603)	-
R6, R7, R16	3	1M ohm Trimmer Potentiometers	Bourns Inc. PV36W105C01B00
R8	1	62k ohm 1% resistor (0603)	-
R9	1	13k ohm 1% resistors (0603)	-
R10	1	6.2k ohm 1% resistors (0603)	-
R11	1	100k ohm Trimmer Potentiometers	Bourns Inc. 3296W-1-104LF
R12, R13	2	10k ohm 1% resistors (0603)	-
R14	1	100k ohm 1% resistors (0603)	-
R17, R18	2	2.7k ohm 1% resistors (0805)	-
R19, R20	2	0 ohm 5% resistors (0805)	-
TP1, TP5, TP17	3	Red Banana Connector	Keystone Electronics Corp 7006
TP2, TP6, TP12, TP18	4	Red Test Point	Keystone Electronics Corp 5000
TP3, TP7	2	Black Banana Connector	Keystone Electronics Corp 7007
TP4, TP8, TP22-TP27	8	Black Test Point	Keystone Electronics Corp 5001
TP9-TP11, TP14, TP16, TP20	6	Yellow Test Point	Keystone Electronics Corp 5004
TP15	1	White Test Point	Keystone Electronics Corp 5002
TP21	1	Orange Test Point	Keystone Electronics Corp 5003
U1	1	5.5V to 60V, 6A Current-Limiter with OV, UV, Reverse Protection, and Power Limit (20-Pin TQFN-EP 5mm x 5mm)	MAX17526AATP+
C6	0	10µF 20%, 63V aluminium electrolytic (5mm)	Panasonic ECA-1JHG100
JU11	0	2-Pin Single-Row Header, 0.1in centers, cut to fit	Sullins Connector PEC02SAAN
R2-R5, R21, R22	0	0603 Resistors (Open)	-
PCB	1	PCB: MAX17526A Evaluation Kit	-

MAX17526A EV System Schematic

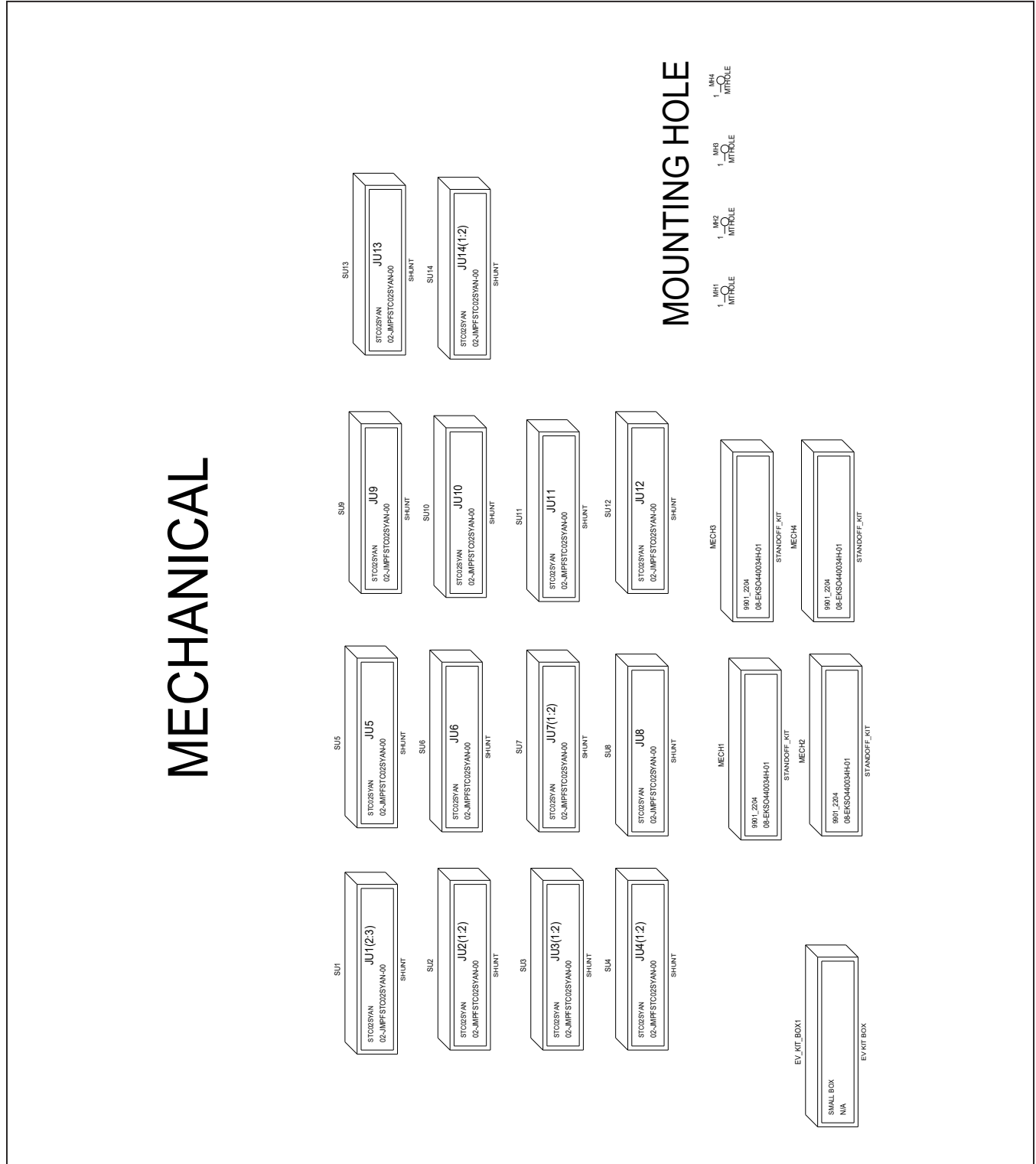

MAX17526A Evaluation Kit

Evaluates: MAX17526A – 5.5V to 60V, 6A
Current Limiter with OV, UV, Reverse
Protection, and Power Limit

MAX17526A EV System Schematic (continued)

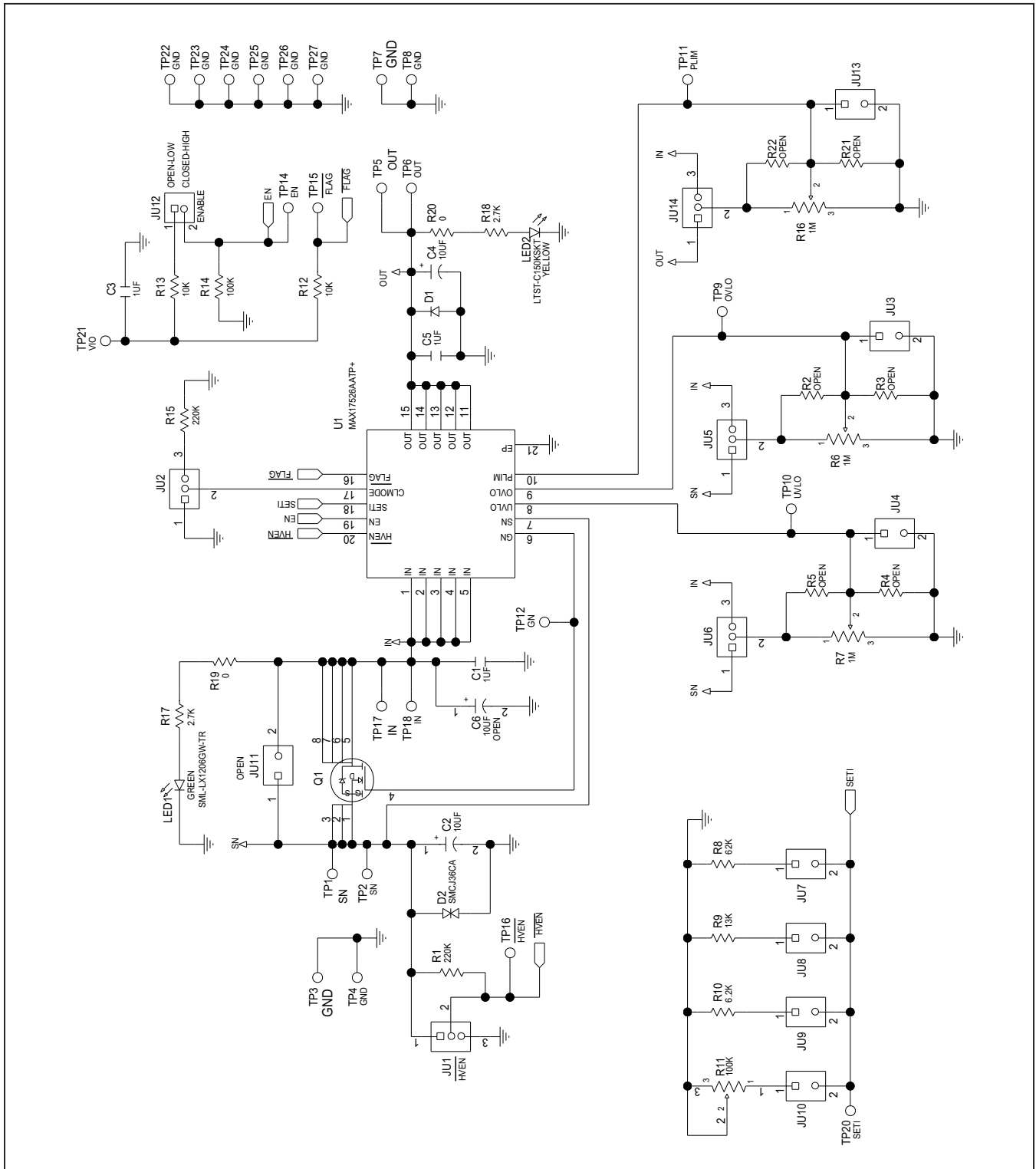

MAX17526A Evaluation Kit

Evaluates: MAX17526A – 5.5V to 60V, 6A
Current Limiter with OV, UV, Reverse
Protection, and Power Limit

MAX17526A EV System PCB Layouts

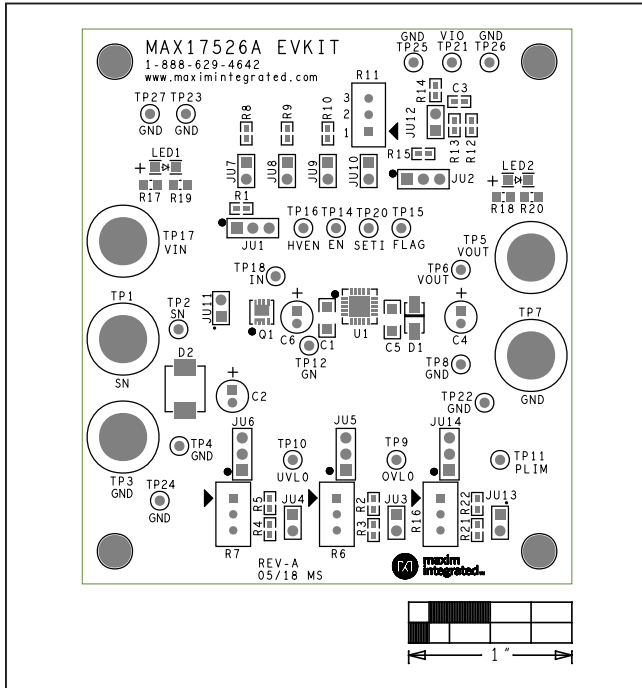

Silk_Top

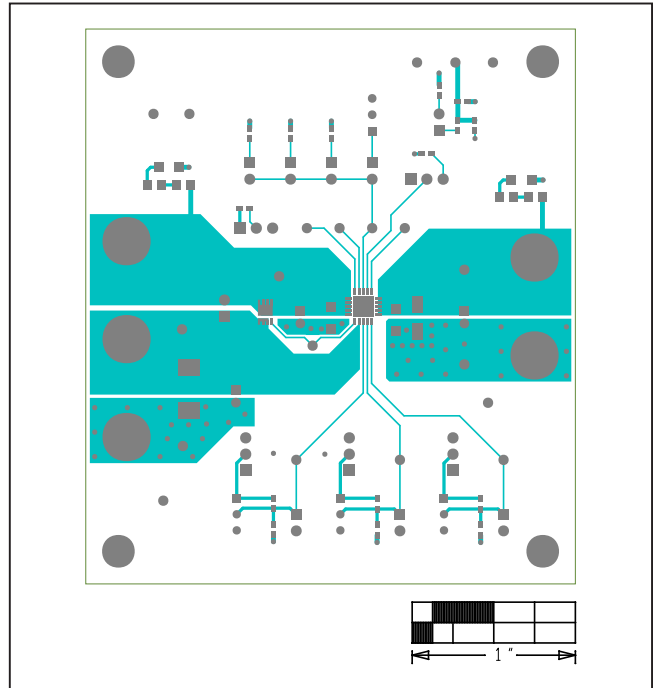

Top

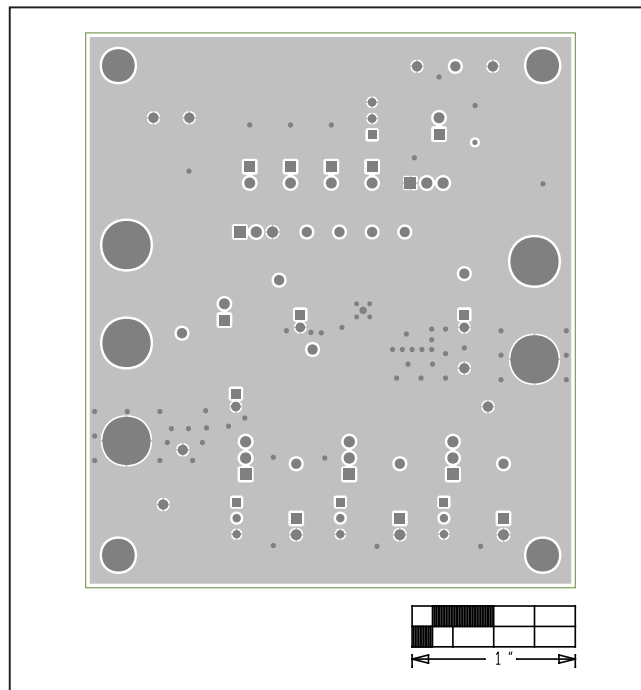

INTERNAL2

MAX17526A EV System PCB Layouts (continued)

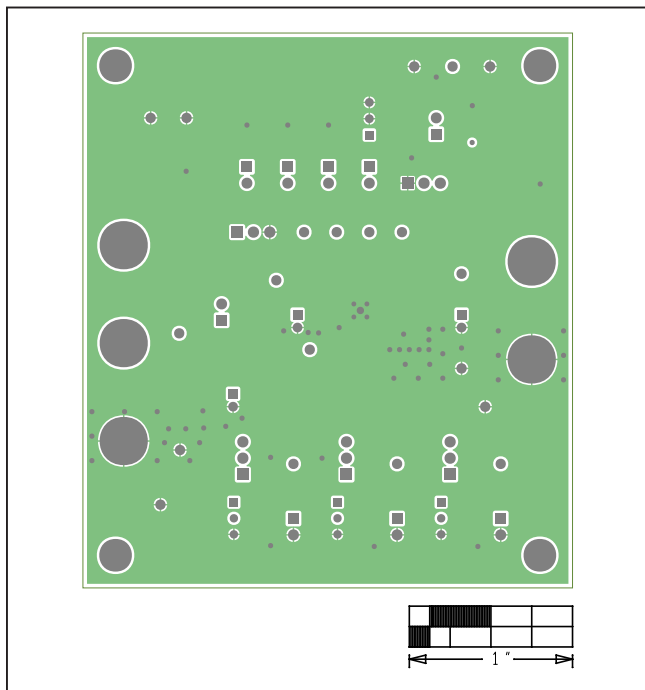

INTERNAL3

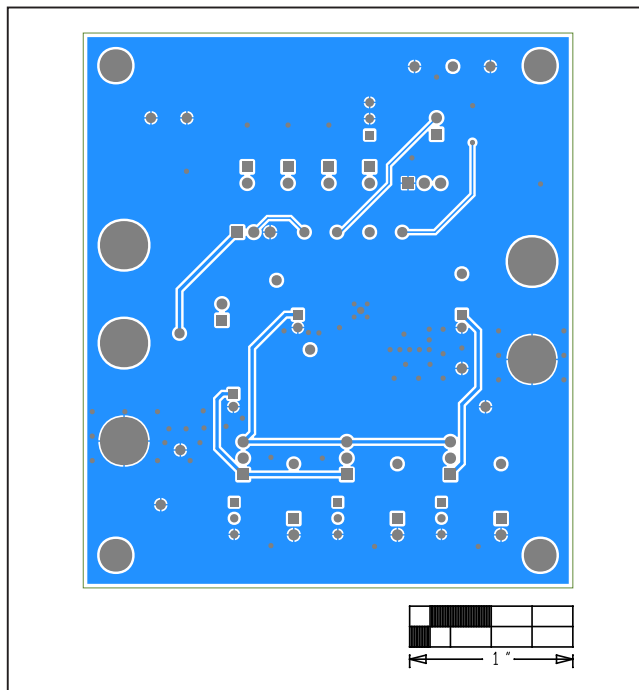

Bottom

MAX17526A Evaluation Kit

Evaluates: MAX17526A – 5.5V to 60V, 6A
Current Limiter with OV, UV, Reverse
Protection, and Power Limit

Revision History

REVISION NUMBER	REVISION DATE	DESCRIPTION	PAGES CHANGED
0	6/18	Initial release	—

For pricing, delivery, and ordering information, please contact Maxim Direct at 1-888-629-4642, or visit Maxim's website at www.maximintegrated.com.

Maxim Integrated cannot assume responsibility for use of any circuitry other than circuitry entirely embodied in a Maxim Integrated product. No circuit patent licenses are implied. Maxim Integrated reserves the right to change the circuitry and specifications without notice at any time. The parametric values (min and max limits) shown in the Electrical Characteristics table are guaranteed. Other parametric values quoted in this data sheet are provided for guidance.