

FEATURES

AVAILABLE OPTIONS	CHARACTERISTICS	CODE	No.
DISPLAY FORMAT	16 Characters by 2 Lines	FC1602N04	1~6
POLARIZER OPTIONS	Positive Transflective	F	7
BACKLIGHT TYPE OPTIONS	Edge Type LED Backlight (Long life span version)	H	8
BACKLIGHT COLOR OPTIONS	Yellow-Green color	Y	9
LCD PANEL OPTIONS	Yellow-Green STN	Y	10
VIEWING ANGLE OPTIONS	6:00 (Bottom)	B	11
TEMPERATURE RANGE OPTIONS	-20°C ~ 70°C, Single Supply Voltage	W	12
SUGGESTED DRIVING VOLTAGE	V _{lcm} = 3.0V V _{led} = 3.0V	9	13
SUGGESTED LED DRIVING MODE	PIN15: LED+, PIN16:LED-	1	14
CONTROLLER ▲1	SPLC780D+SPLC100A	L	15
FONT MAP CODE	E Version	E	16
DRIVING DUTY	1/16	—	—
DRIVING BIAS	1/5	—	—

▲1 Please ask for datasheet of the mentioned controller from FORDATA or FORDATA's authorized distributors. You can find the related information including AC & DC characteristics, Write & Read Timing diagram, Instruction table and descriptions, DDRAM & CGRAM, Rest Function and so on from the datasheet of controller.

▲1 You can ask for the example of software program (C language) from FORDATA or FORDATA's authorized distributors.



MECHANICAL SPECIFICATIONS

OVERALL SIZE	80.0W x 36.0H	mm	THICKNESS	max 13.5	mm
VIEWING AREA	64.5W x 13.8H	mm	HOLE-HOLE	75.0W x 31.0H	mm
CHARACTER SIZE	2.95W x 4.35H	mm	CHARACTER PITCH	0.7W x 0.7H	mm
DOT SIZE	0.55W x 0.50H	mm	DOT PITCH	0.05W x 0.05H	mm

ABSOLUTE MAXIMUM RATINGS

ITEM	SYMBOL	CONDITION	MIN	TYP	MAX	UNIT
POWER SUPPLY (LOGIC)	V _{dd}	25°C	-0.3	—	7.0	V
POWER SUPPLY (LCD)	V ₀	25°C	V _{dd} -13.5	—	V _{dd} +0.3	V
INPUT VOLTAGE	V _{in}	25°C	-0.3	—	V _{dd} +0.3	V
OPERATING TEMPERATURE	V _{opr}	—	-20	—	70	°C
STORAGE TEMPERATURE	V _{stg}	—	-30	—	80	°C

ELECTRONIC CHARACTERISTICS *

ICONS	ITEM	SYMBOL	CONDITION	MIN	TYP	MAX	UNIT
	INPUT VOLTAGE	V _{lcm} = V _{dd}	—	—	3.0	—	V
	SUPPLY CURRENT	I _{dd}	V _{dd} =3V	—	1.5	—	mA
	DRIVING VOLTAGE FOR LCD PANEL	V _{lcd} = (V _{dd} - V ₀)	-20°C	—	—	—	V
			0°C	—	—	—	
			25°C	—	—	—	
			50°C	—	—	—	
			70°C	—	—	—	

* All data are recorded from TEST REPORT #FSYP000700078

LCD CHARACTERISTICS

FOR STN/FSTN TYPE LCD Panel (TA=25 °C, Vdd=5.0V ± 0.5V)

ICONS	ITEM	SYMBOL	CONDITION	MIN	TYP	MAX	UNIT
	VIEWING ANGLE	$\Phi 2 - \Phi 1$	K=4	40	—	—	deg
		θ		60			
	CONTRAST RATIO	K	—	—	10	—	—
	RESPONSE TIME(RISE)	TR	—	—	150	250	ms
	RESPONSE TIME(FALL)	TF	—	—	150	250	ms

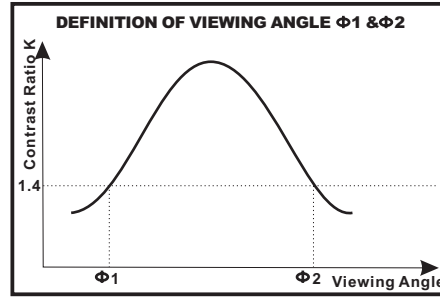
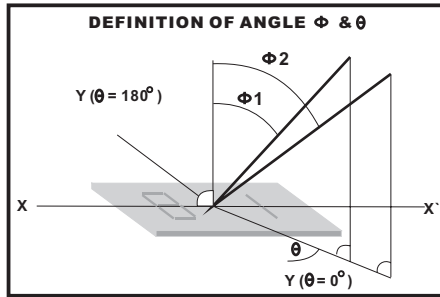

LED CHARACTERISTICS

ICONS	ITEM	SYMBOL	CONDITION	MIN	TYP	MAX	UNIT
	LED FORWARD VOLTAGE	Vf	25°C If = 5mA	—	3.0	—	V
	LED FORWARD CURRENT ▲2	If	25°C	—	5	—	mA
	LED REVERSE CURRENT	Ir	25°C Vr=5.0V	—	—	10	μA
	LED PEAK WAVE LENGTH	λp	25°C If = 5mA	569	—	575	nm
	LED BRIGHTNESS (WITHOUT LCD)	Lv	25°C If = 5mA	—	140	—	cd/m ²
	LED BRIGHTNESS UNIFORMITY	Lvmin/Lvmax	25°C If = 5mA	70	—	—	Ratio
	LED LIFE TIME	—	25°C If = 5mA	20K	—	—	Hours

▲2 请注意, 驱动背光考虑的是恒流而不是恒压. 所以, 这个数值非常重要!

YOUR ATTENTION: It is constant current (not constant voltage) that should be applied when driving LED backlight. Therefore, this data is very important!

* 当工作温度高于25°C时, Ifm, Ifp和Pd必须降低; 电流降低率是 -0.36*1mA/°C (直流驱动), 或-0.86*1 mA/°C (脉冲驱动), 功率降低率是-75*1mW/°C. 产品工作电流不能大于对应的工作条件温度Ifm或Ifpr的60%.
 For operation above 25°C, The Ifm Ifp & Pd must be derated, the Current derating is -0.36*1mA/°C for DC drive and -0.86*1 mA/°C for Pulse drive, the power dissipation is -75*1 mW/°C The product working current must not be more than 60% of the Ifm or Ifp according to the working temperature.



PIN ASSIGNMENT

PIN	SYMBOL	DESCRIPTION	REMARKS
1	Vss	GND	
2	Vdd	Power supply for LCM	3.0V
3	NC	No connection	
4	RS	Register Select Signal	
5	R/W	Data Read / Write	
6	E	Enable Signal	
7	DB0	Data bus line	
8	DB1	Data bus line	
9	DB2	Data bus line	
10	DB3	Data bus line	
11	DB4	Data bus line	
12	DB5	Data bus line	
13	DB6	Data bus line	
14	DB7	Data bus line	
15	LED+	Power supply for BKL	3.0V
16	LED-	Power supply for BKL	

BLOCK DIAGRAM

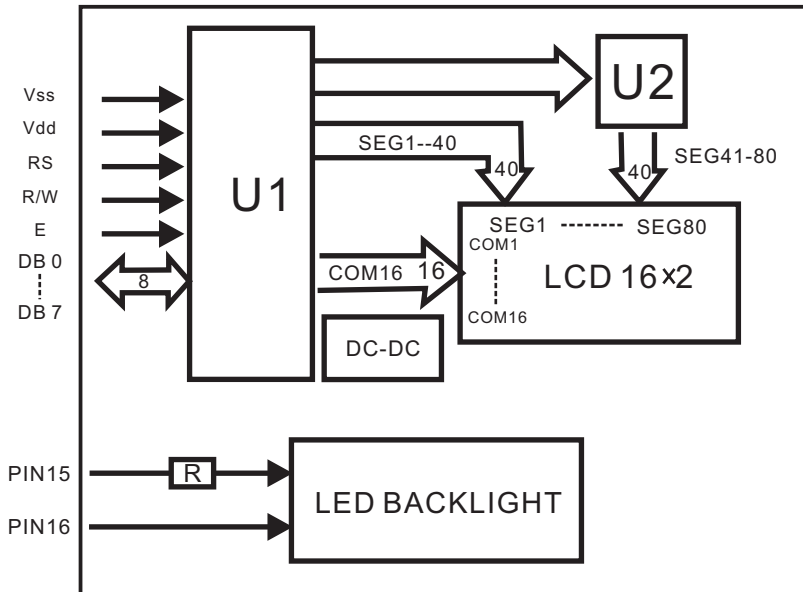

POWER SUPPLY DIAGRAM

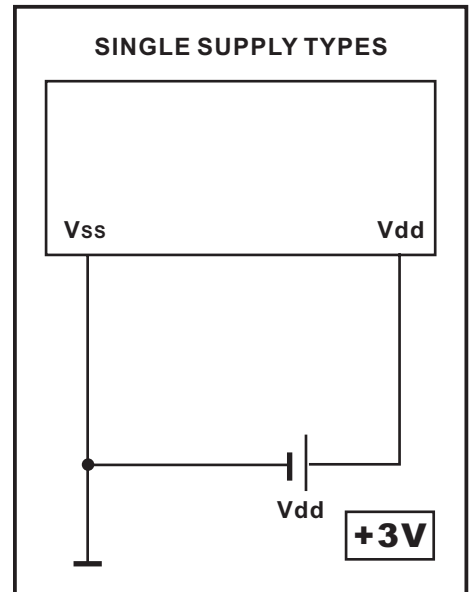

Upper 4bit Lower 4bit	LLLL	LLLH	LLHL	LLHH	LHLL	LHLH	LHHL	LHHH	HLLL	HLLH	HLHL	HLHH	HHLL	HHLH	HHHL	HHHH
LLLL	CG RAM (1)															
LLLH	(2)															
LLHL	(3)															
LLHH	(4)															
LHLL	(5)															
LHLH	(6)															
LHHL	(7)															
LHHH	(8)															
HLLL	(1)															
HLLH	(2)															
HLHL	(3)															
HLHH	(4)															
HHLL	(5)															
HHLH	(6)															
HHHL	(7)															
HHHH	(8)															



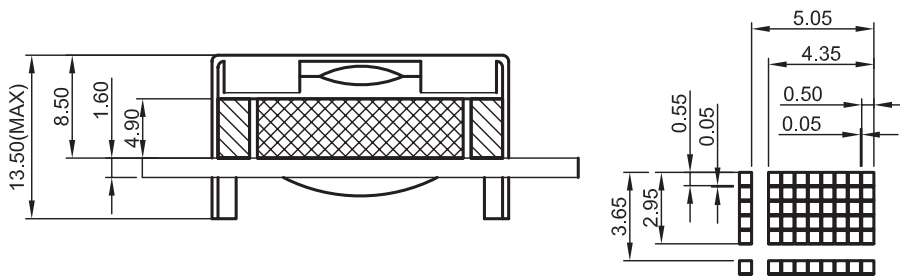
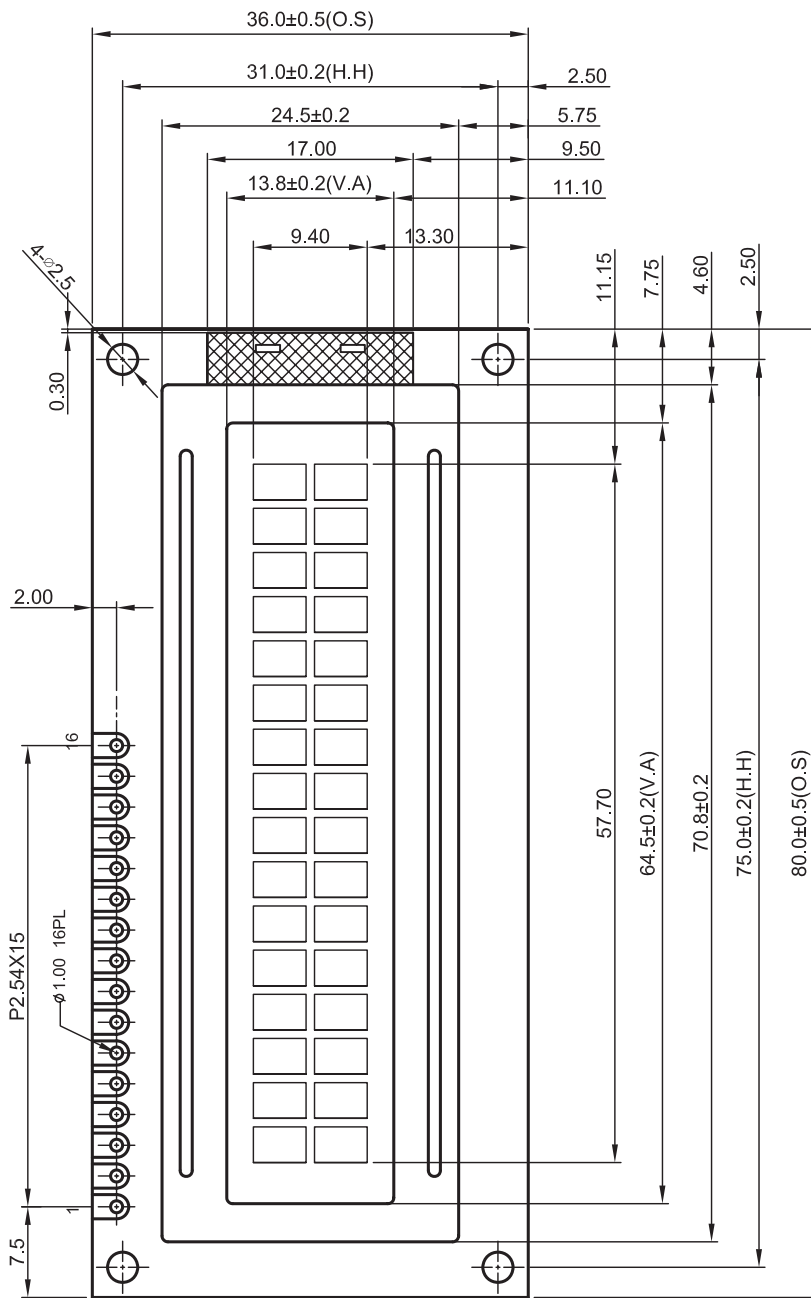

FULL-SIZED PACKAGE
45 PCS/BOX
10 BOXES/CARTON
450 PCS/CARTON
13.00 KGS/CTN(G.W.)
0.054 M ³ /CARTON

HALF-SIZED PACKAGE
45 PCS/BOX
5 BOXES/CARTON
225 PCS/CARTON
6.00 KGS/CTN(G.W.)
0.027 M ³ /CARTON

PACKING DECLARATION
1. This packaging information is for reference only. The actual information is subject to the actual packaging. Especially for packaging of LCL, tolerances may exist.
2. FORDATA will not be responsible for quality problems caused by unnormal transportation conditions (including but not limited to climate factors or human factors, such as improper handling).

