



Figure can vary

Part no.: 68601048
MLC520-S-14-480
Safety sensor set



Contents

- Technical data
- Dimensioned drawings
- Electrical connection
- Part number code
- Accessories

Part no.: 68601048 – MLC520-S-14-480 – Safety sensor set

Technical data

Basic data	
Series	MLC 520S
Device type	Set (transmitter and receiver)
Contains	4x BT-MLC-S-C mounting brackets 4x BT-MLC-S-O mounting brackets
Application	Finger protection
Functions	
Functions	Automatic start/restart Contactor monitoring (EDM) Start/restart interlock (RES)
Characteristic parameters	
Type	4 , IEC/EN 61496
SIL	3 , IEC 61508
SILCL	3 , IEC/EN 62061
Performance Level (PL)	e , EN ISO 13849-1
PFH _D	2,64E-09 per hour
Mission time T _M	20 years , EN ISO 13849-1
Category	4 , EN ISO 13849
Protective field data	
Resolution	14 mm
Protective field height	480 mm
Operating range	0.2 ... 6 m
Optical data	
Number of beams	48 Piece(s)
Synchronization	Optical between transmitter and receiver
Light source	LED , Infrared
LED light wavelength	850 nm
Transmitted-signal shape	Pulsed
LED group	Exempt group in acc. with EN 62471:2008
Electrical data	
Protective circuit	Overvoltage protection Short circuit protected
Performance data	
Supply voltage U _B	24 V , DC , -20 ... 20 %

Outputs

Number of safety-related switching outputs (OSSDs) 2 Piece(s)

Safety-related switching outputs

Type	Safety-related switching output OSSD
Switching voltage high, min.	18 V
Switching voltage low, max.	2.5 V
Switching voltage, typ.	22.5 V
Voltage type	DC
Load inductivity	2,000 µH
Load capacity	1 µF
Residual current, max.	200 mA
Residual current, typ.	2 mA

Safety-related switching output 1

Assignment	Receiver device connection, pin 2
Switching element	Transistor , PNP

Safety-related switching output 2

Assignment	Receiver device connection, pin 4
Switching element	Transistor , PNP

Timing

Response time 10 ms

Connection

Number of connections 2 Piece(s)

Connection 1

Type of connection	Cable with connector
Function	Transmitter device connection
Cable length	160 mm
Sheathing material	PUR
Thread size	M12
Material	Plastic
No. of pins	5 -pin

Connection 2

Type of connection	Cable with connector
Function	Receiver device connection
Cable length	160 mm
Sheathing material	PUR
Thread size	M12
Material	Plastic
No. of pins	5 -pin

Mechanical data

Dimension (W x H x L)	15.4 mm x 480 mm x 32.6 mm
Housing material	Metal , Aluminum
Lens cover material	Plastic / PMMA
Material of end caps	Plastic
Net weight	2,450 g
Housing color	Yellow, RAL 1021

Part no.: 68601048 – MLC520-S-14-480 – Safety sensor set

Type of fastening	C-shaped mounting bracket L-shaped mounting bracket O-shaped mounting bracket
-------------------	---

Environmental data

Ambient temperature, operation	-10 ... 55 °C
Ambient temperature, storage	-30 ... 70 °C
Relative humidity (non-condensing)	15 ... 95 %

Certifications

Degree of protection	IP 65
Protection class	III
Certifications	TÜV Süd
Vibration resistance	50 m/s ²
Shock resistance	98.1 m/s ²
US patents	US 6,418,546 B

Classification

Customs tariff number	85365019
eCl@ss 8.0	27272704
eCl@ss 9.0	27272704
ETIM 5.0	EC002549
ETIM 6.0	EC002549

Dimensioned drawings

All dimensions in millimeters

Dimensions of transmitter and receiver

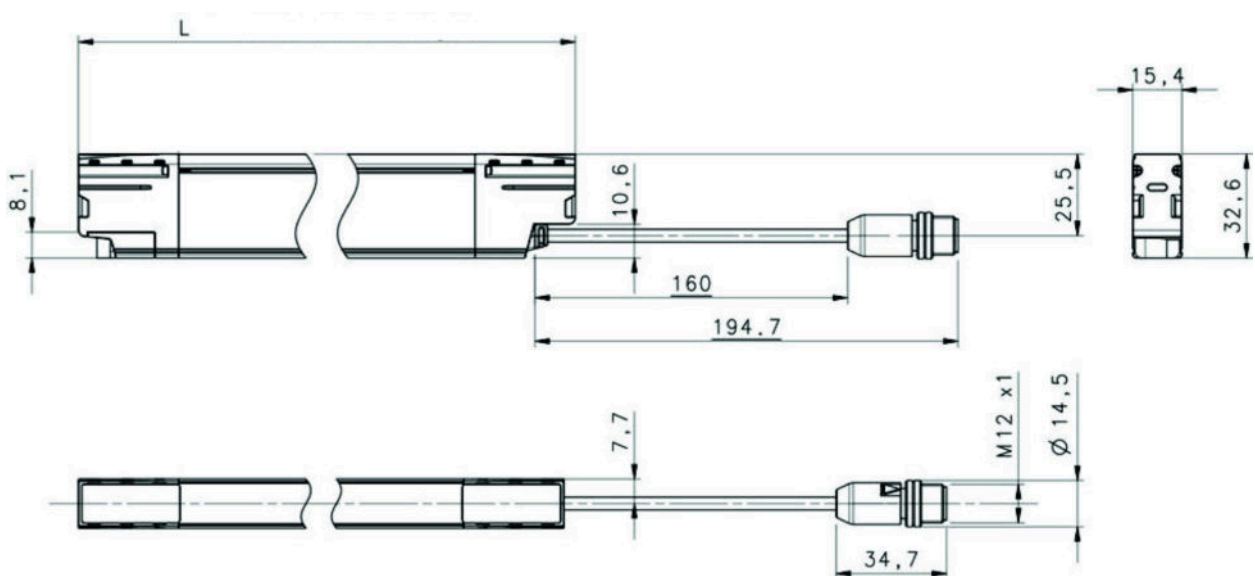

L Length/protective field height

Electrical connection

Connection 1	Transmitter
Type of connection	Cable with connector
Function	Transmitter device connection
Cable length	160 mm
Sheathing material	PUR
Cable color	Black
Wire cross section	
Thread size	M12
Type	Male
Material	Plastic
No. of pins	5 -pin
Encoding	A-coded
Connector housing	FE/SHIELD

Pin	Pin assignment	Conductor color
1	+24 V DC	Brown
2	RESTART SELECTION	White
3	0 V	Blue
4	n.c.	Black
5	RESTART SELECTION	Gray



Connection 2	Receiver
Type of connection	Cable with connector
Function	Receiver device connection
Cable length	160 mm
Sheathing material	PUR
Cable color	Black
Wire cross section	
Thread size	M12
Type	Male
Material	Plastic
No. of pins	5 -pin
Encoding	A-coded
Connector housing	FE/SHIELD

Pin	Pin assignment	Conductor color
1	EDM	Brown
2	OSSD1	White
3	0 V	Blue
4	OSSD2	Black
5	EDM FBK/SELECTION	Gray



Part number code

Part designation: **MLCxxx-ooo-aa-hhhh**

Part no.: 68601048 – MLC520-S-14-480 – Safety sensor set

MLC	Safety light curtain
xxx	Series: 520: MLC 520S
aa	Resolution: 14: 14 mm 24: 24 mm
hhhh	Protective field height: 150 ... 1200: from 150 mm to 1200 mm
ooo	Option: S: Slimline version

Note

A list with all available device types can be found on the Leuze electronic website at www.leuze.com.

Accessories

Connection technology - Connection cables

	Part no.	Designation	Article	Description
	50133841	KD U-M12-5A-P1-050	Connection cable	Connection 1: Connector, M12, Axial, Female, A-coded, 5 -pin Connection 2: Open end Shielded: No Cable length: 5,000 mm Sheathing material: PUR

Services

	Part no.	Designation	Article	Description
	S981050	CS40-I-140	Safety inspection "Safety light barriers"	Details: Checking of a safety light barrier application in accordance with current standards and guidelines. Inclusion of the device and machine data in a database, production of a test log per application. Conditions: It must be possible to stop the machine, support provided by customer's employees and access to the machine for Leuze employees must be ensured. Restrictions: Travel costs and accommodation expenses charged separately and according to expenditure.
	S981046	CS40-S-140	Start-up support	Details: For safety devices including stopping time measurement and initial inspection. Conditions: Devices and connection cables are already mounted, price not including travel costs and, if applicable, accommodation expenses. Restrictions: Max. 2 h., no mechanical (mounting) and electrical (wiring) work performed, no changes (attachments, wiring, programming) to third-party components in the nearby environment.

Note

A list with all available accessories can be found on the Leuze electronic website in the Download tab of the article detailed page.