

SD-C Series 450W Discrete Bidirectional TVS Diode

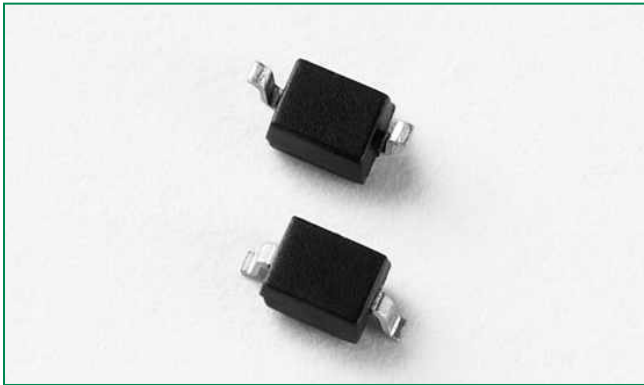

Pinout and Functional Block Diagram

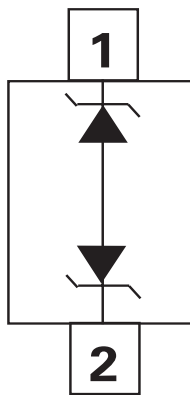

Description

The SD-C series can safely absorb repetitive ESD strikes at $\pm 30\text{kV}$ (contact discharge, IEC 61000-4-2) without performance degradation and safely dissipate 30A (SD05C) of 8/20 μs induced surge current (IEC 61000-4-5 2nd Edition) with very low clamping voltages.

Features

- ESD, IEC 61000-4-2, $\pm 30\text{kV}$ contact, $\pm 30\text{kV}$ air
- EFT, IEC 61000-4-4, 40A (5/50ns)
- Lightning, 30A (8/20 μs as defined in IEC 61000-4-5 2nd edition) SD05C
- Low clamping voltage
- Low leakage current
- Small SOD323 package fits 0805 footprints
- AEC-Q101 qualified
- RoHS Compliant and Lead Free
- Moisture Sensitivity Level

Applications

- Switches / Buttons
- Test Equipment / Instrumentation
- Point-of-Sale Terminals
- Medical Equipment
- Notebooks / Desktops / Servers
- Computer Peripherals
- Automotive Electronics

Additional Information



Datasheet



Resources



Samples

Life Support Note:

Not Intended for Use in Life Support or Life Saving Applications

The products shown herein are not designed for use in life sustaining or life saving applications unless otherwise expressly indicated.

Absolute Maximum Ratings

| Symbol | Parameter | Value | Units |
|------------|--------------------------------------|------------|-------|
| P_{pk} | Peak Pulse Power ($t_p=8/20\mu s$) | 450 | W |
| T_{OP} | Operating Temperature | -40 to 125 | °C |
| T_{STOR} | Storage Temperature | -55 to 150 | °C |

Note:

CAUTION: Stresses above those listed in "Absolute Maximum Ratings" may cause permanent damage to the device. This is a stress only rating and operation of the component at these or any other conditions above those indicated in the operational sections of this specification is not implied.

SD05C Electrical Characteristics ($T_{OP}=25^\circ C$)

| Parameter | Symbol | Test Conditions | Min | Typ | Max | Units |
|------------------------------------|---------------|-----------------------------------|----------|------|------|----------|
| Reverse Standoff Voltage | V_{RWM} | $I_R=1\mu A$ | - | - | 5.0 | V |
| Breakdown Voltage | V_{BR} | $I_R=1mA$ | 6.0 | - | - | V |
| Reverse Leakage Current | I_{LEAK} | $V_R=5V$ | - | - | 1.0 | μA |
| Clamp Voltage ¹ | V_C | $I_{PP}=1A, t_p=8/20\mu s, Fwd$ | - | - | 10.0 | V |
| | | $I_{PP}=10A, t_p=8/20\mu s, Fwd$ | - | - | 14.5 | V |
| Dynamic Resistance ² | R_{DYN} | TLP, $t_p=100ns, I/O$ to Ground | - | 0.31 | - | Ω |
| Peak Pulse Current | I_{PP} | $t_p=8/20\mu s$ | - | - | 30.0 | A |
| ESD Withstand Voltage ¹ | V_{ESD} | IEC 61000-4-2 (Contact Discharge) | ± 30 | - | - | kV |
| | | IEC 61000-4-2 (Air Discharge) | ± 30 | - | - | kV |
| Diode Capacitance ¹ | $C_{I/O-I/O}$ | Reverse Bias=0V, f=1MHz | - | - | 200 | pF |

SD12C Electrical Characteristics ($T_{OP}=25^\circ C$)

| Parameter | Symbol | Test Conditions | Min | Typ | Max | Units |
|------------------------------------|---------------|-----------------------------------|----------|------|------|----------|
| Reverse Standoff Voltage | V_{RWM} | $I_R=1\mu A$ | - | - | 12.0 | V |
| Breakdown Voltage | V_{BR} | $I_R=1mA$ | 13.3 | - | - | V |
| Reverse Leakage Current | I_{LEAK} | $V_R=12V$ | - | - | 1.0 | μA |
| Clamp Voltage ¹ | V_C | $I_{PP}=1A, t_p=8/20\mu s, Fwd$ | - | - | 18.5 | V |
| | | $I_{PP}=10A, t_p=8/20\mu s, Fwd$ | - | - | 23.0 | V |
| Dynamic Resistance ² | R_{DYN} | TLP, $t_p=100ns, I/O$ to Ground | - | 0.41 | - | Ω |
| Peak Pulse Current | I_{PP} | $t_p=8/20\mu s$ | - | - | 17.0 | A |
| ESD Withstand Voltage ¹ | V_{ESD} | IEC 61000-4-2 (Contact Discharge) | ± 30 | - | - | kV |
| | | IEC 61000-4-2 (Air Discharge) | ± 30 | - | - | kV |
| Diode Capacitance ¹ | $C_{I/O-I/O}$ | Reverse Bias=0V, f=1MHz | - | - | 100 | pF |

SD15C Electrical Characteristics (T_{OP}=25°C)

| Parameter | Symbol | Test Conditions | Min | Typ | Max | Units |
|------------------------------------|----------------------|---|------|------|------|-------|
| Reverse Standoff Voltage | V _{RWM} | I _R =1μA | - | - | 15.0 | V |
| Breakdown Voltage | V _{BR} | I _R =1mA | 16.7 | - | - | V |
| Reverse Leakage Current | I _{LEAK} | V _R =15V | - | - | 1.0 | μA |
| Clamp Voltage ¹ | V _C | I _{PP} =1A, t _p =8/20μs, Fwd | - | - | 24.0 | V |
| | | I _{PP} =10A, t _p =8/20μs, Fwd | - | - | 31.0 | V |
| Dynamic Resistance ² | R _{DYN} | TLP, tp=100ns, I/O to Ground | - | 0.46 | - | Ω |
| Peak Pulse Current | I _{PP} | t _p =8/20μs | - | - | 12.0 | A |
| ESD Withstand Voltage ¹ | V _{ESD} | IEC 61000-4-2 (Contact Discharge) | ±30 | - | - | kV |
| | | IEC 61000-4-2 (Air Discharge) | ±30 | - | - | kV |
| Diode Capacitance ¹ | C _{I/O-I/O} | Reverse Bias=0V, f=1MHz | - | - | 75 | pF |

SD24C Electrical Characteristics (T_{OP}=25°C)

| Parameter | Symbol | Test Conditions | Min | Typ | Max | Units |
|------------------------------------|----------------------|--|------|------|------|-------|
| Reverse Standoff Voltage | V _{RWM} | I _R =1μA | - | - | 24.0 | V |
| Breakdown Voltage | V _{BR} | I _R =1mA | 26.7 | - | - | V |
| Reverse Leakage Current | I _{LEAK} | V _R =24V | - | - | 1.0 | μA |
| Clamp Voltage ¹ | V _C | I _{PP} =1A, t _p =8/20μs, Fwd | - | - | 34.0 | V |
| | | I _{PP} =5A, t _p =8/20μs, Fwd | - | - | 42.0 | V |
| Dynamic Resistance ² | R _{DYN} | TLP, tp=100ns, I/O to Ground | - | 0.62 | - | Ω |
| Peak Pulse Current | I _{PP} | t _p =8/20μs | - | - | 7.0 | A |
| ESD Withstand Voltage ¹ | V _{ESD} | IEC 61000-4-2 (Contact Discharge) | ±30 | - | - | kV |
| | | IEC 61000-4-2 (Air Discharge) | ±30 | - | - | kV |
| Diode Capacitance ¹ | C _{I/O-I/O} | Reverse Bias=0V, f=1MHz | - | - | 50 | pF |

SD36C Electrical Characteristics (T_{OP}=25°C)

| Parameter | Symbol | Test Conditions | Min | Typ | Max | Units |
|------------------------------------|----------------------|--|------|------|------|-------|
| Reverse Standoff Voltage | V _{RWM} | I _R =1μA | - | - | 36.0 | V |
| Breakdown Voltage | V _{BR} | I _R =1mA | 40.0 | - | - | V |
| Reverse Leakage Current | I _{LEAK} | V _R =36V | - | - | 1.0 | μA |
| Clamp Voltage ¹ | V _C | I _{PP} =1A, t _p =8/20μs, Fwd | - | - | 50.0 | V |
| | | I _{PP} =4A, t _p =8/20μs, Fwd | - | - | 60.0 | V |
| Dynamic Resistance ² | R _{DYN} | TLP, tp=100ns, I/O to Ground | - | 0.68 | - | Ω |
| Peak Pulse Current | I _{PP} | t _p =8/20μs | - | - | 5.0 | A |
| ESD Withstand Voltage ¹ | V _{ESD} | IEC 61000-4-2 (Contact Discharge) | ±30 | - | - | kV |
| | | IEC 61000-4-2 (Air Discharge) | ±30 | - | - | kV |
| Diode Capacitance ¹ | C _{I/O-I/O} | Reverse Bias=0V, f=1MHz | - | - | 30 | pF |

Note:

- Parameter is guaranteed by design and/or component characterization.
- Transmission Line Pulse (TLP) with 100ns width and 200ps rise time.

Capacitance vs. Bias

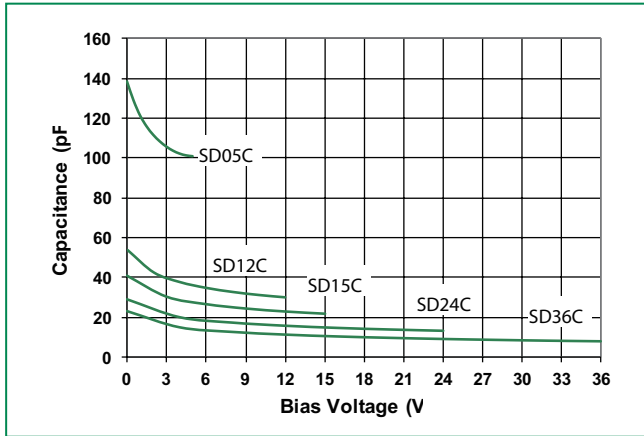

Power Derating Curve

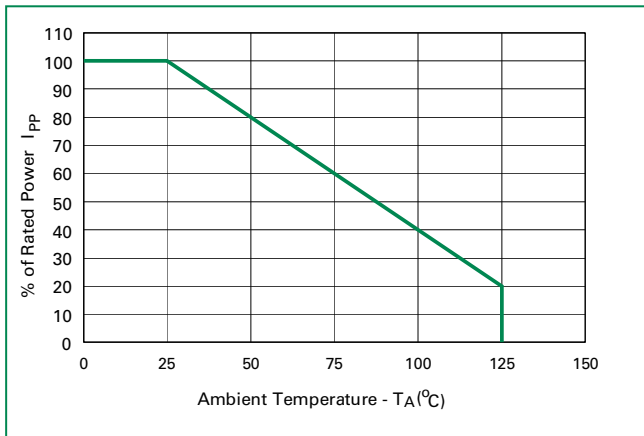

8/20 μ s Pulse Waveform

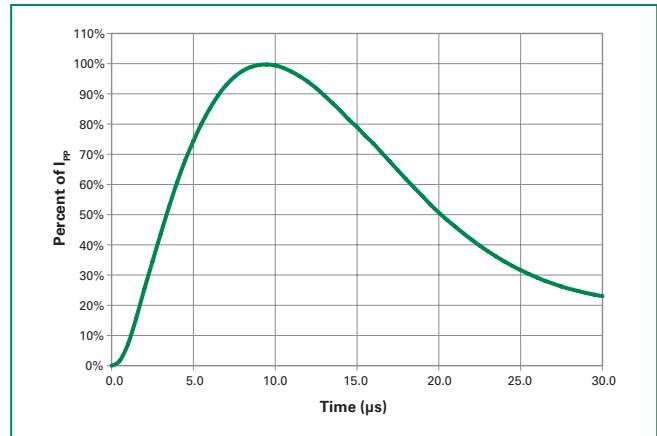

SD05C Transmission Line Pulsing (TLP) Plot

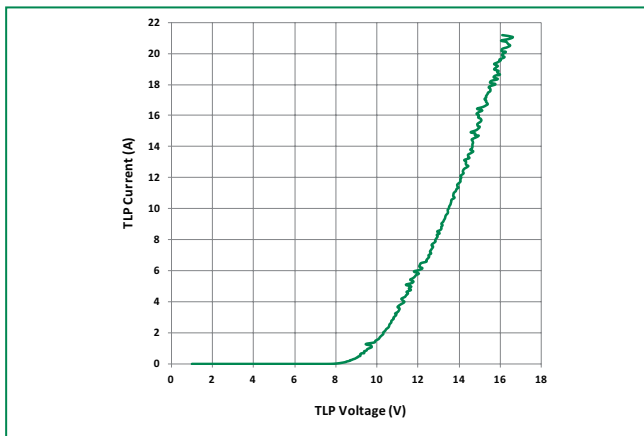

SD12C Transmission Line Pulsing (TLP) Plot

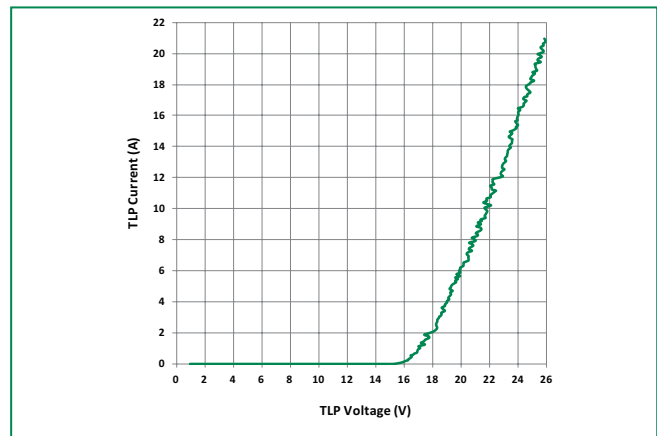

SD15C Transmission Line Pulsing(TLP) Plot

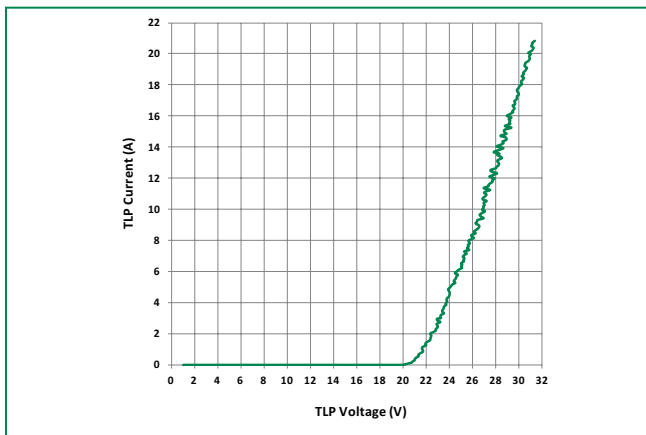

SD24C Transmission Line Pulsing(TLP) Plot

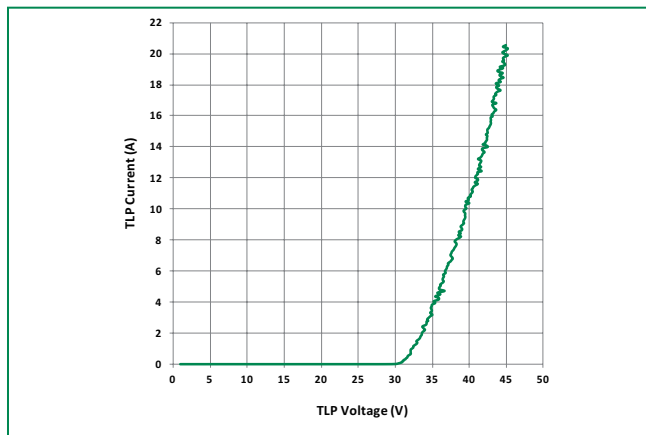

SD36C Transmission Line Pulsing(TLP) Plot

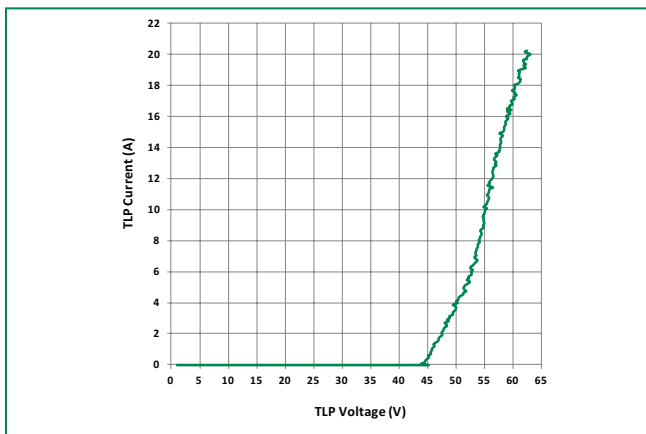

Soldering Parameters

| | | |
|--|------------------------------------|-------------------------|
| Reflow Condition | | Pb – Free assembly |
| Pre Heat | - Temperature Min ($T_{s(min)}$) | 150°C |
| | - Temperature Max ($T_{s(max)}$) | 200°C |
| | - Time (min to max) (t_s) | 60 – 180 secs |
| Average ramp up rate (Liquidus) Temp (T_L) to peak | | 3°C/second max |
| $T_{s(max)}$ to T_L - Ramp-up Rate | | 3°C/second max |
| Reflow | - Temperature (T_L) (Liquidus) | 217°C |
| | - Temperature (t_L) | 60 – 150 seconds |
| Peak Temperature (T_p) | | 260 ^{+0/-5} °C |
| Time within 5°C of actual peak Temperature (t_p) | | 20 – 40 seconds |
| Ramp-down Rate | | 6°C/second max |
| Time 25°C to peak Temperature (T_p) | | 8 minutes Max. |
| Do not exceed | | 260°C |

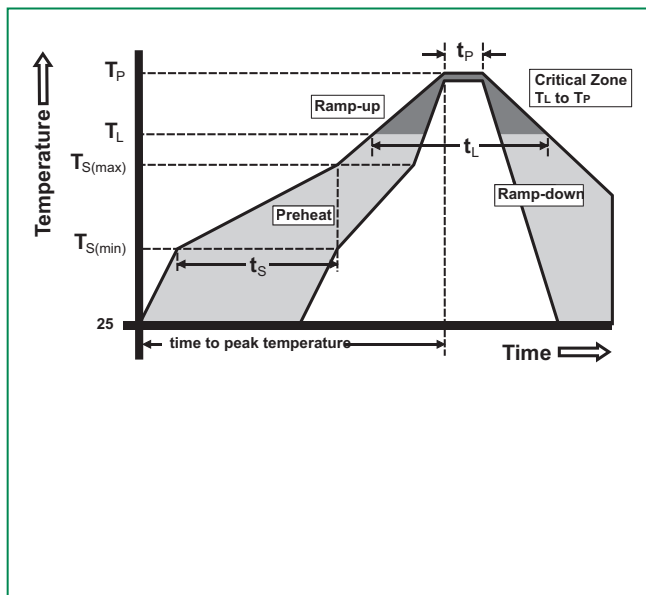

Product Characteristics

| | |
|---------------------------|--|
| Lead Plating | Matte Tin |
| Lead Material | Copper Alloy |
| Lead Coplanarity | 0.0004 inches (0.102mm) |
| Substrate material | Silicon |
| Body Material | Molded Compound |
| Flammability | UL Recognized compound meeting flammability rating V-0 |

Ordering Information

| Part Number | Package | Min. Order Qty. |
|-------------|---------|-----------------|
| SD05C-01FTG | SOD323 | 3000 |
| SD12C-01FTG | SOD323 | 3000 |
| SD15C-01FTG | SOD323 | 3000 |
| SD24C-01FTG | SOD323 | 3000 |
| SD36C-01FTG | SOD323 | 3000 |

Part Marking System

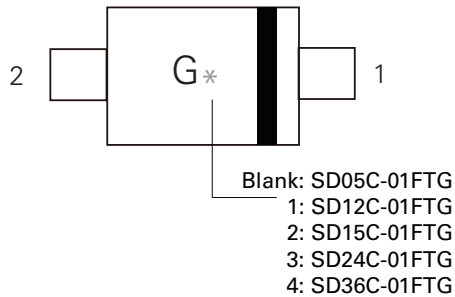

Part Numbering System

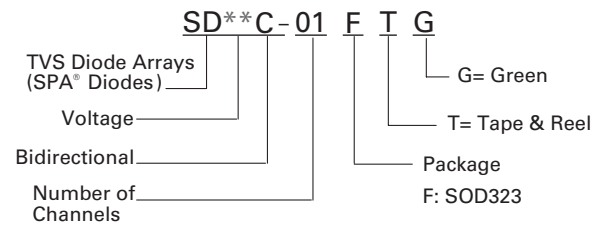

Package Dimensions -SOD323

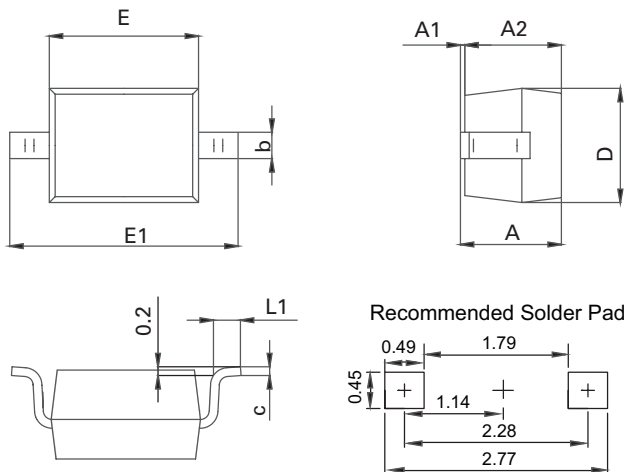

| Symbol | SOD323 | | | |
|-----------|-------------|------|--------|-------|
| | Millimeters | | Inches | |
| | Min | Max | Min | Max |
| A | 0.8 | 1.14 | 0.031 | 0.045 |
| A1 | 0.00 | 0.10 | 0.000 | 0.004 |
| A2 | 0.80 | 1.04 | 0.031 | 0.014 |
| b | 0.25 | 0.35 | 0.010 | 0.014 |
| c | 0.08 | 0.15 | 0.003 | 0.006 |
| D | 1.15 | 1.45 | 0.045 | 0.057 |
| E | 1.60 | 1.90 | 0.063 | 0.075 |
| E1 | 2.44 | 2.70 | 0.096 | 0.106 |
| L1 | 0.25 | 0.45 | 0.010 | 0.018 |

Embossed Carrier Tape & Reel Specification – SOD323

