



## Retroreflective sensor (glass)

### OBG8000-R200-EP-IO-0,3M-V3



- Medium design with versatile mounting options
- Detects transparent objects, i.e., clear glass, PET and transparent films
- Two machines in one: clear object detection or reflection operating mode with long range
- High degree of protection IP69K
- IO-Link interface for service and process data

Retroreflective sensor with polarization filter for clear object detection



### Function

The optical sensors in the series are the first devices to offer an end-to-end solution in a medium-sized standard design – from the thru-beam sensor through to the measuring distance sensor. As a result of this design, the sensors are able to perform practically all standard automation tasks.

The entire series enables sensors to communicate via IO-Link.

The DuraBeam laser sensors are durable and can be used in the same way as a standard sensor.

Multi Pixel Technology (MPT) ensures that the standard sensors are flexible and can be adapted to the application environment.

### Dimensions

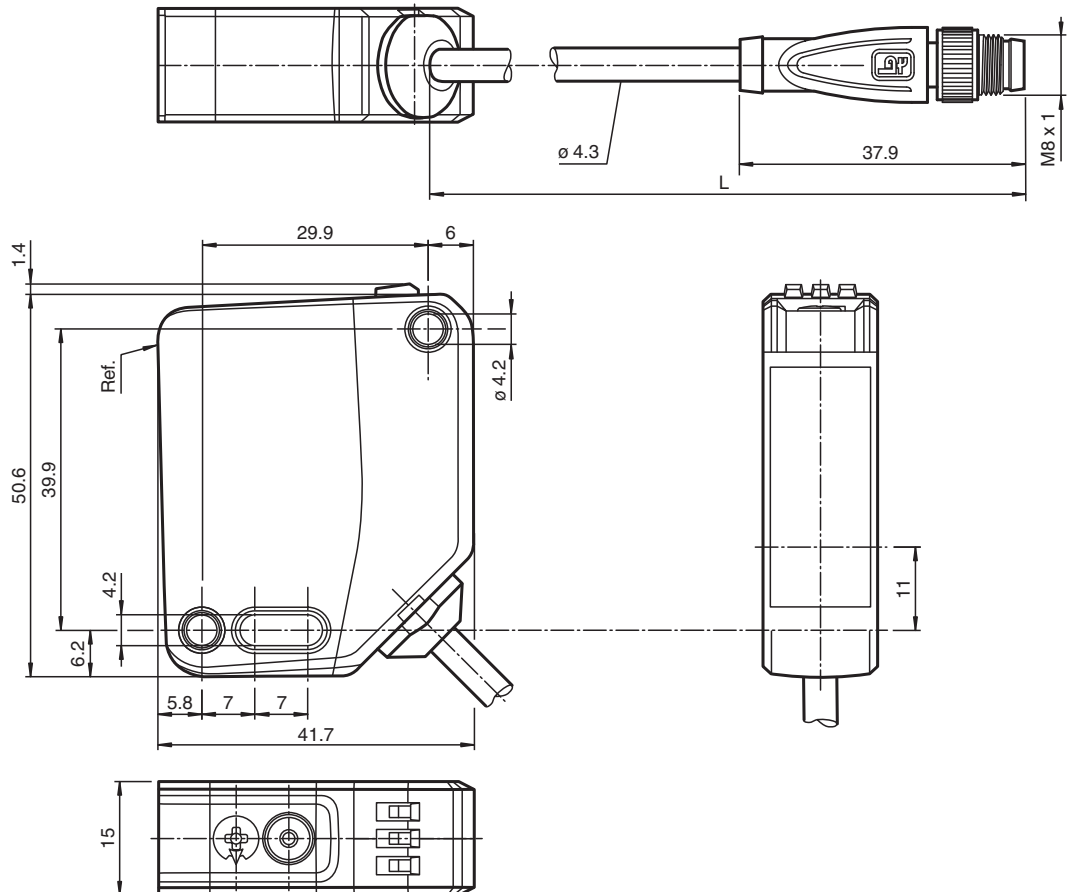

## Technical Data

| General specifications               |   |
|--------------------------------------|---|
| Effective detection range            | 0 ... 5.6 m in TEACH mode ; 0 ... 8 m at switch position "N"  |
| Reflector distance                   | 0 ... 5.6 m in TEACH mode ; 0 ... 8 m at switch position "N"  |
| Threshold detection range            | 9 m   |
| Reference target                     | H85-2 reflector   |
| Light source                         | LED   |
| Light type                           | modulated visible red light   |
| LED risk group labelling             | exempt group  |
| Polarization filter                  | yes   |
| Diameter of the light spot           | approx. 170 mm at a distance of 3.5 m   |
| Opening angle                        | approx. 5 °   |
| Ambient light limit                  | EN 60947-5-2 : 18000 Lux  |
| Functional safety related parameters |   |
| MTTF <sub>d</sub>                    | 600 a   |
| Mission Time (T <sub>M</sub> )       | 20 a  |
| Diagnostic Coverage (DC)             | 0 %   |
| Indicators/operating means           |   |
| Operation indicator                  | LED green:<br>constantly on - power on<br>flashing (4Hz) - short circuit<br>flashing with short break (1 Hz) - IO-Link mode                                 |
| Function indicator                   | Yellow LED:<br>Permanently lit - light path clear<br>Permanently off - object detected<br>Flashing (4 Hz) - insufficient operating reserve                  |
| Control elements                     | Teach-In key  |
| Control elements                     | 5-step rotary switch for operating modes selection  |
| Contrast detection levels            | 10 % - clean, water filled PET bottles<br>18 % - clear glass bottles<br>40 % - colored glass or opaque materials<br>Adjustable via rotary switch            |
| Electrical specifications            |   |
| Operating voltage                    | U <sub>B</sub> 10 ... 30 V DC   |
| Ripple                               | max. 10 %   |
| No-load supply current               | I <sub>0</sub> < 25 mA at 24 V supply voltage   |
| Protection class                     | III   |
| Interface                            |   |
| Interface type                       | IO-Link ( via C/Q = pin 4 )   |
| IO-Link revision                     | 1.1   |
| Device profile                       | Identification and diagnosis<br>Smart Sensor type 2.4   |
| Device ID                            | 0x111A01 (1120769)  |
| Transfer rate                        | COM2 (38.4 kBaud)   |
| Min. cycle time                      | 2.3 ms  |
| Process data width                   | Process data input 2 Bit<br>Process data output 2 Bit   |
| SIO mode support                     | yes   |
| Compatible master port type          | A   |
| Output                               |   |
| Switching type                       | The switching type of the sensor is adjustable. The default setting is:<br>C/Q - Pin4: NPN normally open / dark-on, PNP normally closed / light-on, IO-Link |
| Signal output                        | 1 push-pull (4 in 1) output, short-circuit protected, reverse polarity protected, overvoltage protected   |
| Switching voltage                    | max. 30 V DC  |
| Switching current                    | max. 100 mA , resistive load  |
| Usage category                       | DC-12 and DC-13   |
| Voltage drop                         | U <sub>d</sub> ≤ 1.5 V DC   |

Release date: 2022-03-30 Date of issue: 2022-03-30 Filename: 295670-100143\_eng.pdf

## Technical Data

|                                   |   |  |
|-----------------------------------|---|--|
| Switching frequency               | f | 500 Hz   |
| Response time                     |   | 1 ms   |
| <b>Conformity</b>                 |   |  |
| Communication interface           |   | IEC 61131-9  |
| Product standard                  |   | EN 60947-5-2   |
| <b>Approvals and certificates</b> |   |  |
| EAC conformity                    |   | TR CU 020/2011   |
| UL approval                       |   | E87056 , cULus Listed , class 2 power supply , type rating 1 |
| CCC approval                      |   | CCC approval / marking not required for products rated ≤36 V |
| <b>Ambient conditions</b>         |   |  |
| Ambient temperature               |   | -20 ... 60 °C (-4 ... 140 °F)                                |
| Storage temperature               |   | -40 ... 70 °C (-40 ... 158 °F)                               |
| <b>Mechanical specifications</b>  |   |  |
| Housing width                     |   | 15 mm  |
| Housing height                    |   | 50.6 mm  |
| Housing depth                     |   | 41.7 mm  |
| Degree of protection              |   | IP67 / IP69 / IP69K  |
| Connection                        |   | 300 mm fixed cable with M8 x 1, 3-pin connector              |
| Material                          |   |  |
| Housing                           |   | PC (Polycarbonate)   |
| Optical face                      |   | PMMA   |
| Mass                              |   | approx. 41 g   |
| Cable length                      |   | 0.3 m  |

## Connection

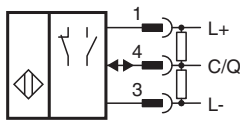

## Connection Assignment



Wire colors in accordance with EN 60947-5-2

|   |    |         |
|---|----|---------|
| 1 | BN | (brown) |
| 3 | BU | (blue)  |
| 4 | BK | (black) |

**Assembly**

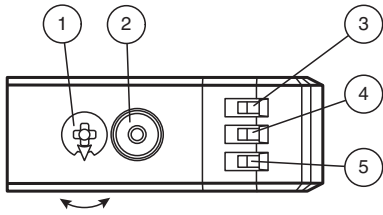

|   |                              |    |
|---|------------------------------|----|
| 1 | Mode rotary switch           |    |
| 2 | Teach-in button              |    |
| 3 | Operating indicator/dark-on  | GN |
| 4 | Function indicator           | YE |
| 5 | Operating indicator/light-on | GN |

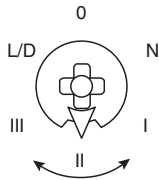

|     |                         |
|-----|-------------------------|
| N   | Normal operation        |
| I   | 10 % contrast detection |
| II  | 18 % contrast detection |
| III | 40 % contrast detection |
| L/D | Switching type          |
| 0   | Keylock                 |

**Characteristic Curve**

**Characteristic response curve**

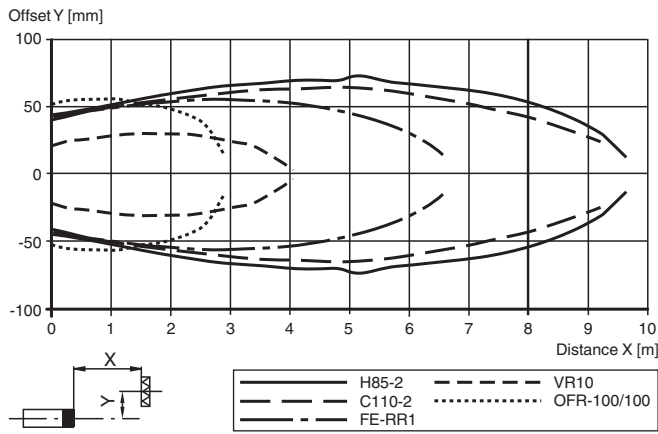



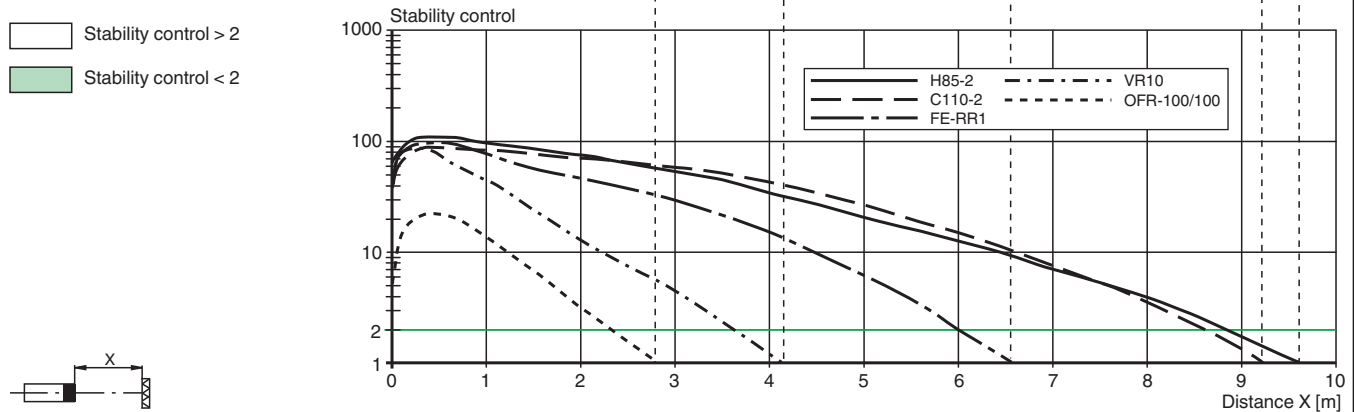
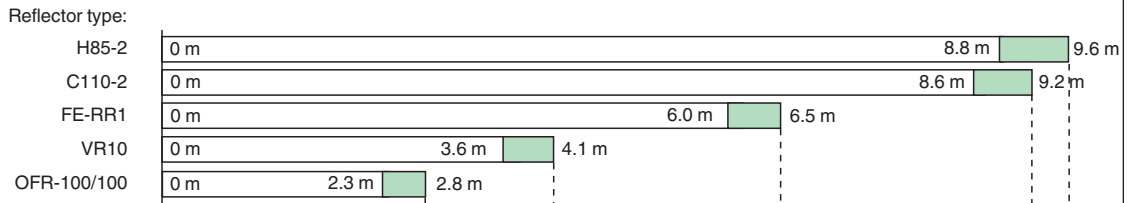















**Relative received light strength in switch position "N" (typical)**



Release date: 2022-03-30 Date of issue: 2022-03-30 Filename: 295670-100143\_eng.pdf

## Accessories



|   |                             |  |
|---|-----------------------------|--|
|    | <b>REF-ORR50G-2</b>         | Reflector  |
|    | <b>REF-H85-2</b>            | Reflector, rectangular 84.5 mm x 84.5 mm, mounting holes   |
|    | <b>REF-C110-2</b>           | Reflector, round ø 84 mm, central mounting hole  |
|    | <b>FE-RR1</b>               | Reflector, round ø 80.87 mm, central mounting hole   |
|    | <b>REF-VR10</b>             | Reflector, rectangular 60 mm x 19 mm, mounting holes   |
|    | <b>OFR-100/100</b>          | Reflective tape 100 mm x 100 mm  |
|    | <b>REF-H32G-2</b>           | Reflector  |
|    | <b>OMH-MLV12-HWG</b>        | Mounting bracket for series MLV12 sensors  |
|   | <b>OMH-R200-01</b>          | Mounting aid for round steel ø 12 mm or sheet 1.5 mm ... 3 mm  |
|  | <b>OMH-MLV12-HWK</b>        | Mounting bracket for series MLV12 sensors  |
|  | <b>OMH-R20x-Quick-Mount</b> | Quick mounting accessory   |
|  | <b>ICE2-8IOL-G65L-V1D</b>   | EtherNet/IP IO-Link master with 8 inputs/outputs   |
|  | <b>ICE3-8IOL-G65L-V1D</b>   | PROFINET IO IO-Link master with 8 inputs/outputs   |
|  | <b>ICE2-8IOL-K45S-RJ45</b>  | EtherNet/IP IO-Link master with 8 inputs/outputs, DIN rail, screw terminal                                   |
|  | <b>ICE3-8IOL-K45P-RJ45</b>  | PROFINET IO IO-Link master with 8 inputs/outputs, DIN rail, push-in terminals                                |
|  | <b>ICE3-8IOL-K45S-RJ45</b>  | PROFINET IO IO-Link master with 8 inputs/outputs, DIN rail, screw terminal                                   |
|  | <b>IO-Link-Master02-USB</b> | IO-Link master, supply via USB port or separate power supply, LED indicators, M12 plug for sensor connection |
|  | <b>ICE1-8IOL-G30L-V1D</b>   | Ethernet IO-Link module with 8 inputs/outputs  |
|  | <b>ICE1-8IOL-G60L-V1D</b>   | Ethernet IO-Link module with 8 inputs/outputs  |
|  | <b>ICE2-8IOL-K45P-RJ45</b>  | EtherNet/IP IO-Link master with 8 inputs/outputs, DIN rail, push-in connectors                               |

Release date: 2022-03-30 Date of issue: 2022-03-30 Filename: 295670-100143\_eng.pdf

Refer to "General Notes Relating to Pepperl+Fuchs Product Information".

Pepperl+Fuchs Group  
www.pepperl-fuchs.comUSA: +1 330 486 0001  
fa-info@us.pepperl-fuchs.comGermany: +49 621 776 1111  
fa-info@de.pepperl-fuchs.comSingapore: +65 6779 9091  
fa-info@sg.pepperl-fuchs.com **PEPPERL+FUCHS**

**Accessories**

|   |                     |  |
|---|---------------------|--|
|  | <b>V3-GM-2M-PUR</b> | Female cordset single-ended M8 straight A-coded, 3-pin, PUR cable grey |
|  | <b>V3-WM-2M-PUR</b> | Female cordset single-ended M8 angled A-coded, 3-pin, PUR cable grey   |

## Settings

### Teach-in:

Use the rotary switch to select the required operating mode: Normal mode (N) or contrast level I – III.

To teach in a threshold or activate an operating mode, press the "TI" button until the yellow and green LEDs flash in phase (approx. 1 s).

Release the "TI" button. Teach-in starts.

Successful teach-in is indicated by alternating flashing (2.5 Hz) of the yellow and green LEDs. The sensor will now operate in the selected operating mode with the taught-in threshold.

An unsuccessful teach-in is indicated by rapidly alternating flashing (8 Hz) of the yellow and green LEDs. After an unsuccessful teach-in, the sensor continues to operate with the previous valid setting after the relevant visual fault signal is issued.

Every taught-in switching threshold can be re-taught (overwritten) by pressing the "TI" button again.

Note: To ensure that the device functions reliably in Contrast mode, the device must be powered on at least 30 s before Teach-in.

### Setting the Device to Maximum Sensitivity

Use the rotary switch to select the Normal mode (N) position.

Press the "TI" button for > 4 s. The yellow and green LEDs will go out.

Release the "TI" button.

The settings will be reset to maximum sensitivity. After successfully resetting, the yellow and green LEDs will flash alternately (2.5 Hz).

### Switching between light on/dark on

Use the rotary switch to select the light on/dark on (L/D) position.

Press the "TI" button for > 1 s.

The respective operating indicator LED (L/D) will illuminate green and the switching type will change.

To reset the switching type, press the "TI" button for > 4 s.

The respective operating indicator LED (L/D) will illuminate green and the operating indicator will be reset to the most recently active switching type.

### Reset to Default Settings

Use the rotary switch to select the O position.

Press the "TI" button for > 10 s. The yellow and the green LEDs will both switch off.

Release the "TI" button. The yellow LED is on.

After resetting, the sensor will operate with the following default settings:

- Normal mode (N)
- Maximum sensitivity adjustment
- Dark on
- Pin 2 (white core): antivalent switching output