

Interference Suppression Film Capacitor - Class X1 Radial MKP 330 V_{AC} - Standard Across the Line



FEATURES

- 7.5 mm to 27.5 mm lead pitch
- Small dimensions
- High voltage capability
- Material categorization:
for definitions of compliance please see www.vishay.com/doc?99912



RoHS
COMPLIANT
HALOGEN
FREE
GREEN
(5-2008)

APPLICATIONS

For standard across the line X1 applications
See also application note: www.vishay.com/doc?28153

QUICK REFERENCE DATA	
Capacitance range (E12 series)	0.001 μ F to 2.2 μ F (preferred values according to E6)
Capacitance tolerance	$\pm 20\%$; $\pm 10\%$; ($\pm 5\%$ on request)
Climatic testing class according to IEC 60068-1	55/110/56/B
Rated AC voltage	330 V _{AC} ; 50 Hz to 60 Hz
Permissible DC voltage	800 V _{DC} at 85 °C
Maximum application temperature	110 °C
Reference standards	IEC 60384-14 and EN 60384-14 IEC 60065 requires pass. flamm. class B CSA-E384-14; UL 60384-14 CQC
Dielectric	Polypropylene film
Electrodes	Metallized
Construction	Mono construction 
Encapsulation	Plastic case, epoxy resin sealed, flame retardant UL-class 94 V-0
Leads	Tinned wire
Marking	C-value; tolerance; rated voltage; sub-class; manufacturer's type; code for dielectric material; manufacturer location, year and week; manufacturer's logo or name; safety approvals

Note

- For more detailed data and test requirements, contact rfi@vishay.com

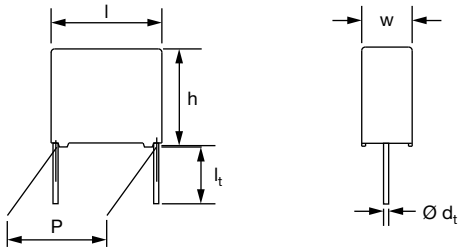
DIMENSIONS in millimeters

Note

- $\varnothing d_t \pm 10\%$ of standard diameter specified



COMPOSITION OF CATALOG NUMBER

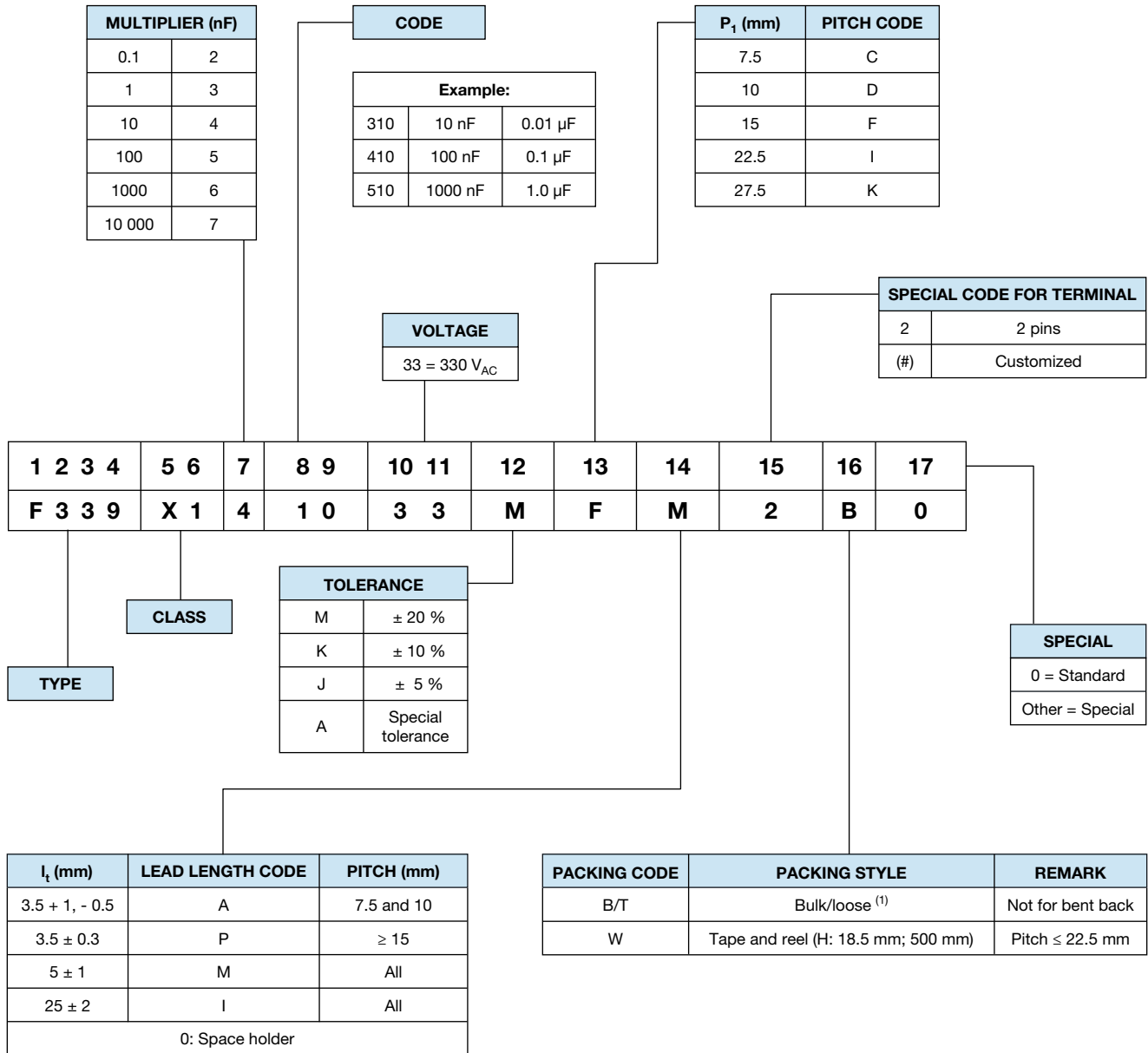

Notes

- For detailed tape specifications refer to packaging information www.vishay.com/doc?28139
- ⁽¹⁾ Packaging will be bulk for all capacitors with pitch ≤ 15 mm and such with long leads (> 5 mm). Capacitors with short leads up to 5 mm and pitch > 15 mm will be in tray and asking code will be "T".



SPECIFIC REFERENCE DATA		
DESCRIPTION	VALUE	
Rated AC voltage (U_{RAC})	330 V	
Permissible DC voltage (U_{RDC})	800 V	
Tangent of loss angle	At 1 kHz	At 10 kHz
$C < 100 \text{ nF}$	$\leq 10 \times 10^{-4}$	$\leq 20 \times 10^{-4}$
$470 \text{ nF} \leq C \leq 2.2 \mu\text{F}$	$\leq 20 \times 10^{-4}$	$\leq 70 \times 10^{-4}$
Rated voltage pulse slope (dU/dt) _R at 465 V _{DC}	100 V/ μs	
R between leads, for $C \leq 0.33 \mu\text{F}$ at 100 V; 1 min	$> 15\,000 \text{ M}\Omega$	
RC between leads, for $C > 0.33 \mu\text{F}$ at 100 V; 1 min	$> 5000 \text{ s}$	
R between leads and case; 100 V; 1 min	$> 30\,000 \text{ M}\Omega$	
Withstanding (DC) voltage (cut off current 10 mA) ⁽¹⁾ ; rise time $\leq 1000 \text{ V/s}$:		
$C \leq 2.2 \mu\text{F}$	3400 V; 1 min	
$C > 2.2 \mu\text{F}$	2200 V; 1 min	
Withstanding (AC) voltage between leads and case	2160 V; 1 min	
Maximum application temperature	110 °C	

Note

⁽¹⁾ See "Voltage Proof Test for Metalized Film Capacitors": www.vishay.com/doc?28169

ELECTRICAL DATA AND ORDERING INFORMATION										
U_{RAC} (V)	CAP. (μF)	DIMENSIONS w x h x l (mm)	MASS (g) ⁽³⁾	CATALOG NUMBER F339X1... AND PACKAGING						
				LOOSE IN BOX					TAPED REEL	
				SHORT LEADS			LONG LEADS			
				$l_t = 3.5 \text{ mm} + 1 \text{ mm} / - 0.5 \text{ mm} (\leq 10 \text{ mm})$ or $3.5 \text{ mm} \pm 0.3 \text{ mm} (\geq 15 \text{ mm})$	$l_t = 5.0 \text{ mm} \pm 1.0 \text{ mm}$	SPQ	$l_t = 25.0 \text{ mm} \pm 2.0 \text{ mm}$	SPQ	$\varnothing = 500 \text{ mm}^{(1)(2)}$ $H = 18.5 \text{ mm};$ $P_0 = 12.7 \text{ mm}$	SPQ
PITCH = 7.5 mm \pm 0.4 mm; $d_t = 0.50 \text{ mm} \pm 0.05 \text{ mm}$; C-TOL. = $\pm 20 \%$										
	0.0010	4.0 x 9.0 x 10.0	0.4	21033MCA2B0	21033MCM2B0	1500	21033MCI2B0	1000	21033MC02W0	2500
	0.0015			21533MCA2B0	21533MCM2B0		21533MCI2B0		21533MC02W0	
	0.0022			22233MCA2B0	22233MCM2B0		22233MCI2B0		22233MC02W0	
	0.0033	5.0 x 10.5 x 10.0	0.4	23333MCA2B0	23333MCM2B0	1000	23333MCI2B0	1250	23333MC02W0	2000
	0.0047	6.0 x 11.5 x 10.0	0.8	24733MCA2B0	24733MCM2B0	750	24733MCI2B0	1000	24733MC02W0	1900
PITCH = 10.0 mm \pm 0.4 mm; $d_t = 0.60 \text{ mm} \pm 0.06 \text{ mm}$; C-TOL. = $\pm 20 \%$										
330	0.0010	4.0 x 10.0 x 12.5	0.6	21033MDA2B0	21033MDM2B0	1000	21033MDI2B0	1250	21033MD02W0	1400
	0.0015			21533MDA2B0	21533MDM2B0		21533MDI2B0		21533MD02W0	
	0.0022			22233MDA2B0	22233MDM2B0		22233MDI2B0		22233MD02W0	
	0.0033			23333MDA2B0	23333MDM2B0		23333MDI2B0		23333MD02W0	
	0.0047			24733MDA2B0	24733MDM2B0		24733MDI2B0		24733MD02W0	
	0.0068			26833MDA2B0	26833MDM2B0		26833MDI2B0		26833MD02W0	
	0.010			31033MDA2B0	31033MDM2B0		31033MDI2B0		31033MD02W0	
	0.015			31533MDA2B0	31533MDM2B0		31533MDI2B0		31533MD02W0	
	0.022	5.0 x 11.0 x 12.5	0.82	32233MDA2B0	32233MDM2B0	1000	32233MDI2B0	1000	32233MD02W0	1100
	0.033	6.0 x 12.0 x 12.5	1.1	33333MDA2B0	33333MDM2B0	750	33333MDI2B0	750	33333MD02W0	900
PITCH = 15.0 mm \pm 0.4 mm; $d_t = 0.60 \text{ mm} \pm 0.06 \text{ mm}$; C-TOL. = $\pm 20 \%$										
	0.010	5.0 x 11.0 x 17.5	1.0	31033MFP2B0	31033MFM2B0	1250	31033MFI2B0	1000	31033MF02W0	1100
	0.015			31533MFP2B0	31533MFM2B0		31533MFI2B0		31533MF02W0	
	0.022			32233MFP2B0	32233MFM2B0		32233MFI2B0		32233MF02W0	
	0.033			33333MFP2B0	33333MFM2B0		33333MFI2B0		33333MF02W0	
	0.047			34733MFP2B0	34733MFM2B0		34733MFI2B0		34733MF02W0	
	0.068	6.0 x 12.0 x 17.5	1.4	36833MFP2B0	36833MFM2B0	1000	36833MFI2B0	1000	36833MF02W0	900
PITCH = 15.0 mm \pm 0.4 mm; $d_t = 0.80 \text{ mm} \pm 0.08 \text{ mm}$; C-TOL. = $\pm 20 \%$										
	0.10	7.0 x 13.5 x 17.5	1.8	41033MFP2B0	41033MFM2B0	750	41033MFI2B0	500	41033MF02W0	800
	0.15	8.5 x 15.0 x 17.5	2.4	41533MFP2B0	41533MFM2B0	750	41533MFI2B0	500	41533MF02W0	650
	0.22	10.0 x 16.5 x 17.5	3.0	42233MFP2B0	42233MFM2B0	500	42233MFI2B0	450	42233MF02W0	600





ELECTRICAL DATA AND ORDERING INFORMATION									
U _{RAC} (V)	CAP. (μF)	DIMENSIONS w x h x l (mm)	MASS (g) ⁽³⁾	CATALOG NUMBER F339X1... AND PACKAGING					
				LOOSE IN BOX				TAPED REEL	
				SHORT LEADS		LONG LEADS			
				l _t = 3.5 mm + 1 mm/- 0.5 mm (≤ 10 mm) or 3.5 mm ± 0.3 mm (≥ 15 mm)	l _t = 5.0 mm ± 1.0 mm	SPQ	l _t = 25.0 mm ± 2.0 mm	SPQ	Ø = 500 mm ⁽¹⁾⁽²⁾ H = 18.5 mm; P ₀ = 12.7 mm
PITCH = 22.5 mm ± 0.4 mm; d _t = 0.80 mm ± 0.08 mm; C-TOL. = ± 20 %									
0.10	6.0 x 15.5 x 26.0	2.4	41033MIP2T0	41033MIM2T0	300	41033MII2B0	250	41033MI02W0	600
0.15			41533MIP2T0	41533MIM2T0		41533MII2B0		41533MI02W0	
0.22	7.0 x 16.5 x 26.0	2.9	42233MIP2T0	42233MIM2T0	200	42233MII2B0	250	42233MI02W0	500
0.33	8.5 x 18.0 x 26.0	3.8	43333MIP2T0	43333MIM2T0	200	43333MII2B0	250	43333MI02W0	450
0.47	10.0 x 19.5 x 26.0	6.8	44733MIP2T0	44733MIM2T0	200	44733MII2B0	200	44733MI02W0	350
0.68	12.0 x 22.0 x 26.0	7.8	46833MIP2T0	46833MIM2T0	150	46833MII2B0	200	46833MI02W0	300
0.82	12.5 x 22.5 x 26.5	7.8	48233MIP2T0	48233MIM2T0	140	48233MII2B0	400	48233MI02W0	300
PITCH = 27.5 mm ± 0.4 mm; d _t = 0.80 mm ± 0.08 mm; C-TOL. = ± 20 %									
0.22	9.0 x 19.0 x 31.5	5.5	42233MKP2T0	42233MKM2T0	100	42233MKI2B0	150		
0.33			43333MKP2T0	43333MKM2T0		43333MKI2B0			
0.47			44733MKP2T0	44733MKM2T0		44733MKI2B0			
0.68	11.0 x 21.0 x 31.0	7.4	46833MKP2T0	46833MKM2T0	100	46833MKI2B0	125	-	-
1.0	13.0 x 23.0 x 31.0	9.2	51033MKP2T0	51033MKM2T0	100	51033MKI2B0	125		
1.5	18.0 x 28.0 x 31.5	16.1	51533MKP2T0	51533MKM2T0	100	51533MKI2B0	100		
2.2	21.0 x 31.0 x 31.0	20.3	52233MKP2T0	52233MKM2T0	50	52233MKI2B0	75		
PITCH = 7.5 mm ± 0.4 mm; d _t = 0.50 mm ± 0.05 mm; C-TOL. = ± 10 %									
0.0010	4.0 x 9.0 x 10.0	0.4	21033KCA2B0	21033KCM2B0	1500	21033KCI2B0	1000	21033KC02W0	2500
0.0012			21233KCA2B0	21233KCM2B0		21233KCI2B0		21233KC02W0	
0.0015			21533KCA2B0	21533KCM2B0		21533KCI2B0		21533KC02W0	
0.0018			21833KCA2B0	21833KCM2B0		21833KCI2B0		21833KC02W0	
0.0022			22233KCA2B0	22233KCM2B0		22233KCI2B0		22233KC02W0	
0.0027			22733KCA2B0	22733KCM2B0		22733KCI2B0		22733KC02W0	
0.0033	5.0 x 10.5 x 10.0	0.4	23333KCA2B0	23333KCM2B0	1000	23333KCI2B0	1250	23333KC02W0	2000
0.0039			23933KCA2B0	23933KCM2B0		23933KCI2B0		23933KC02W0	
0.0047	6.0 x 11.5 x 10.0	0.8	24733KCA2B0	24733KCM2B0	750	24733KCI2B0	1000	24733KC02W0	1900
0.0056			25633KCA2B0	25633KCM2B0		25633KCI2B0		25633KC02W0	
PITCH = 10.0 mm ± 0.4 mm; d _t = 0.60 mm ± 0.06 mm; C-TOL. = ± 10 %									
0.0010	4.0 x 10.0 x 12.5	0.6	21033KDA2B0	21033KDM2B0	1000	21033KDI2B0	1250	21033KD02W0	1400
0.0012			21233KDA2B0	21233KDM2B0		21233KDI2B0		21233KD02W0	
0.0015			21533KDA2B0	21533KDM2B0		21533KDI2B0		21533KD02W0	
0.0018			21833KDA2B0	21833KDM2B0		21833KDI2B0		21833KD02W0	
0.0022			22233KDA2B0	22233KDM2B0		22233KDI2B0		22233KD02W0	
0.0027			22733KDA2B0	22733KDM2B0		22733KDI2B0		22733KD02W0	
0.0033			23333KDA2B0	23333KDM2B0		23333KDI2B0		23333KD02W0	
0.0039			23933KDA2B0	23933KDM2B0		23933KDI2B0		23933KD02W0	
0.0047			24733KDA2B0	24733KDM2B0		24733KDI2B0		24733KD02W0	
0.0056			25633KDA2B0	25633KDM2B0		25633KDI2B0		25633KD02W0	
0.0068			26833KDA2B0	26833KDM2B0		26833KDI2B0		26833KD02W0	
0.0082			28233KDA2B0	28233KDM2B0		28233KDI2B0		28233KD02W0	
0.010			31033KDA2B0	31033KDM2B0		31033KDI2B0		31033KD02W0	
0.012			31233KDA2B0	31233KDM2B0		31233KDI2B0		31233KD02W0	
0.015			31533KDA2B0	31533KDM2B0		31533KDI2B0		31533KD02W0	
0.018			5.0 x 11.0 x 12.5	0.82		31833KDA2B0		31833KDM2B0	
0.022	32233KDA2B0	32233KDM2B0			32233KDI2B0	32233KD02W0			
0.027	6.0 x 12.0 x 12.5	1.1	32733KDA2B0	32733KDM2B0	750	32733KDI2B0	750	32733KD02W0	900
0.033			33333KDA2B0	33333KDM2B0		33333KDI2B0		33333KD02W0	



ELECTRICAL DATA AND ORDERING INFORMATION										
U _{RAC} (V)	CAP. (μF)	DIMENSIONS w x h x l (mm)	MASS (g) ⁽³⁾	CATALOG NUMBER F339X1... AND PACKAGING						
				LOOSE IN BOX					TAPED REEL	
				SHORT LEADS			LONG LEADS			
				l _t = 3.5 mm + 1 mm/- 0.5 mm (≤ 10 mm) or 3.5 mm ± 0.3 mm (≥ 15 mm)		l _t = 5.0 mm ± 1.0 mm	SPQ	l _t = 25.0 mm ± 2.0 mm	SPQ	Ø = 500 mm ⁽¹⁾⁽²⁾ H = 18.5 mm; P ₀ = 12.7 mm
PITCH = 15.0 mm ± 0.4 mm; d _t = 0.60 mm ± 0.06 mm; C-TOL. = ± 10 %										
0.010	5.0 x 11.0 x 17.5	1.0	31033KFP2B0	31033KFM2B0	1000	31033KFI2B0	1000	31033KF02W0	1100	
0.012			31233KFP2B0	31233KFM2B0		31233KFI2B0		31233KF02W0		
0.015			31533KFP2B0	31533KFM2B0		31533KFI2B0		31533KF02W0		
0.018			31833KFP2B0	31833KFM2B0		31833KFI2B0		31833KF02W0		
0.022			32233KFP2B0	32233KFM2B0		32233KFI2B0		32233KF02W0		
0.027			32733KFP2B0	32733KFM2B0		32733KFI2B0		32733KF02W0		
0.033			33333KFP2B0	33333KFM2B0		33333KFI2B0		33333KF02W0		
0.039			33933KFP2B0	33933KFM2B0		33933KFI2B0		33933KF02W0		
0.047			34733KFP2B0	34733KFM2B0		34733KFI2B0		34733KF02W0		
0.056			6.0 x 12.0 x 17.5	1.4		35633KFP2B0		35633KFM2B0		1000
0.068	36833KFP2B0	36833KFM2B0			36833KFI2B0	36833KF02W0				
PITCH = 15.0 mm ± 0.4 mm; d _t = 0.80 mm ± 0.08 mm; C-TOL. = ± 10 %										
0.082	7.0 x 13.5 x 17.5	1.8	38233KFP2B0	38233KFM2B0	1000	38233KFI2B0	500	38233KF02W0	800	
0.100			41033KFP2B0	41033KFM2B0		41033KFI2B0		41033KF02W0		
0.120	8.5 x 15.0 x 17.5	2.4	41233KFP2B0	41233KFM2B0	1000	41233KFI2B0	500	41233KF02W0	650	
0.150			41533KFP2B0	41533KFM2B0		41533KFI2B0		41533KF02W0		
0.180	10.0 x 16.5 x 17.5	3.0	41833KFP2B0	41833KFM2B0	500	41833KFI2B0	500	41833KF02W0	600	
PITCH = 22.5 mm ± 0.4 mm; d _t = 0.80 mm ± 0.08 mm; C-TOL. = ± 10 %										
0.10	6.0 x 15.5 x 26.0	2.4	41033KIP2T0	41033KIM2T0	300	41033KII2B0	250	41033KI02W0	600	
0.12			41233KIP2T0	41233KIM2T0		41233KII2B0		41233KI02W0		
0.15			41533KIP2T0	41533KIM2T0		41533KII2B0		41533KI02W0		
0.18	7.0 x 16.5 x 26.0	2.9	41833KIP2T0	41833KIM2T0	200	41833KII2B0	250	41833KI02W0	500	
0.22			42233KIP2T0	42233KIM2T0		42233KII2B0		42233KI02W0		
0.27	8.5 x 18.0 x 26.0	3.8	42733KIP2T0	42733KIM2T0	200	42733KII2B0	250	42733KI02W0	450	
0.33			43333KIP2T0	43333KIM2T0		43333KII2B0		43333KI02W0		
0.39	10.0 x 19.5 x 26.0	6.8	43933KIP2T0	43933KIM2T0	200	43933KII2B0	200	43933KI02W0	350	
0.47	12.0 x 22.0 x 26.0	7.8	44733KIP2T0	44733KIM2T0	150	44733KII2B0	200	44733KI02W0	300	
0.56			45633KIP2T0	45633KIM2T0		45633KII2B0		45633KI02W0		
0.68	12.5 x 22.5 x 26.5	8.0	46833KIP2T0	46833KIM2T0	150	46833KII2B0	200	46833KI02W0	300	
PITCH = 27.5 mm ± 0.4 mm; d _t = 0.80 mm ± 0.08 mm; C-TOL. = ± 10 %										
0.22	9.0 x 19.0 x 31.5	5.5	42233KKP2T0	42233KKM2T0	100	42233KKI2B0	150			
0.27			42733KKP2T0	42733KKM2T0		42733KKI2B0				
0.33			43333KKP2T0	43333KKM2T0		43333KKI2B0				
0.39			43933KKP2T0	43933KKM2T0		43933KKI2B0				
0.47	11.0 x 21.0 x 31.0	7.4	44733KKP2T0	44733KKM2T0	100	44733KKI2B0	125			
0.56			45633KKP2T0	45633KKM2T0		45633KKI2B0				
0.68	13.0 x 23.0 x 31.0	9.2	46833KKP2T0	46833KKM2T0	100	46833KKI2B0	125			
0.82			48233KKP2T0	48233KKM2T0		48233KKI2B0				
1.0	15.0 x 25.0 x 31.5	12.3	51033KKP2T0	51033KKM2T0	100	51033KKI2B0	125			
1.2			51233KKP2T0	51233KKM2T0		51233KKI2B0				
1.5	18.0 x 28.0 x 31.5	16.1	51533KKP2T0	51533KKM2T0	100	51533KKI2B0	100			
1.8	21.0 x 31.0 x 31.0	20.3	51833KKP2T0	51833KKM2T0	50	51833KKI2B0	75			
2.2			52233KKP2T0	52233KKM2T0		52233KKI2B0				

Notes

- SPQ = Standard Packing Quantity
- (1) Reel diameter = 356 mm is available on request
- (2) H = in-tape height; P₀ = sprocket hole distance; for detailed specifications refer to "Packaging Information"
- (3) Weight for short lead product only

APPROVALS				
SAFETY APPROVALS X1	VOLTAGE	VALUE	FILE NUMBERS	LINK
EN 60384-14 (ENEC) (= IEC 60384-14 ed-3)	330 V _{AC}	1 nF to 2.2 μF	40031978	www.vishay.com/doc?28229
UL 60384-14	330 V _{AC}	1 nF to 2.2 μF	E354331B	www.vishay.com/doc?28210
CSA-E384-14	330 V _{AC}	1 nF to 2.2 μF	E354331B	www.vishay.com/doc?28210
CQC	330 V _{AC}	1 nF to 2.2 μF	12001067597 (L)	www.vishay.com/doc?28235
			12001067600 (F)	www.vishay.com/doc?28236
CB-test certificate	330 V _{AC}	1 nF to 2.2 μF	DE1-48009/M1	www.vishay.com/doc?28218
The ENEC-approval together with the CB-certificate replace all national marks of the following countries (they have already signed the ENEC-agreement): Austria; Belgium; Czech. Republic; Denmark; Finland; France; Germany; Greece; Hungary; Ireland; Italy; Luxembourg; Netherlands; Norway; Portugal; Slovenian; Spain; Sweden, Switzerland and United Kingdom.				
  				

MOUNTING

Normal Use

The capacitors are designed for mounting on printed-circuit boards. The capacitors packed in bandoliers are designed for mounting on printed-circuit boards by means of automatic insertion machines.

For detailed tape specifications refer to packaging information www.vishay.com/docs?28139

Specific Method of Mounting to Withstand Vibration and Shock

In order to withstand vibration and shock tests, it must be ensured that the stand-off pips are in good contact with the printed-circuit board:

- For original pitch ≤ 15 mm the capacitors shall be mechanically fixed by the leads
- For larger pitches the capacitors shall be mounted in the same way and the body clamped

Space Requirements on Printed-Circuit Board

The maximum space for length ($l_{max.}$), width ($w_{max.}$) and height ($h_{max.}$) of film capacitors to take in account on the printed circuit board is shown in the drawings.

- For products with pitch ≤ 15 mm, $\Delta w = \Delta l = 0.3$ mm and $\Delta h = 0.1$ mm
- For products with 15 mm $<$ pitch ≤ 27.5 mm, $\Delta w = \Delta l = 0.5$ mm and $\Delta h = 0.1$ mm

Eccentricity defined as in drawing. The maximum eccentricity is smaller than or equal to the lead diameter of the product concerned.

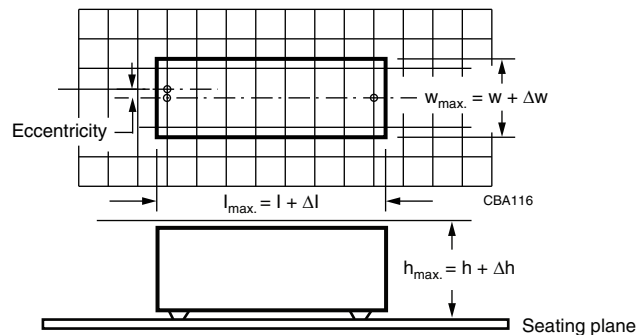

SOLDERING CONDITIONS

For general soldering conditions and wave soldering profile we refer to the document "Soldering Guidelines for Film Capacitors": www.vishay.com/doc?28171

STORAGE TEMPERATURE

$T_{stg} = -25$ °C to $+35$ °C with RH maximum 75 % without condensation

RATINGS AND CHARACTERISTICS REFERENCE CONDITIONS

Unless otherwise specified, all electrical values apply to an ambient free temperature of 23 °C ± 1 °C, an atmospheric pressure of 86 kPa to 106 kPa and a relative humidity of 50 % ± 2 %.

For reference testing, a conditioning period shall be applied over 96 h ± 4 h by heating the products in a circulating air oven at the rated temperature and a relative humidity not exceeding 20 %.



CHARACTERISTICS

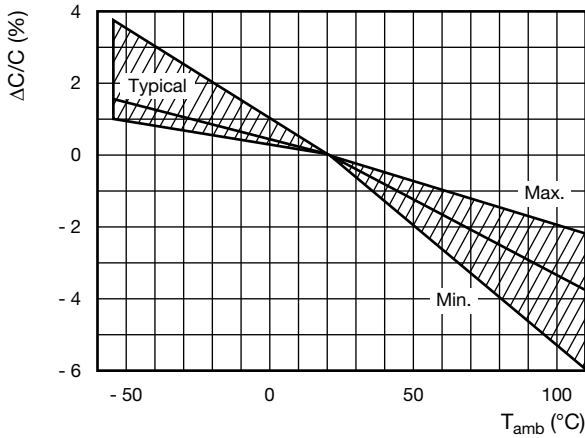

Capacitance as a function of ambient temperature (typical curve)

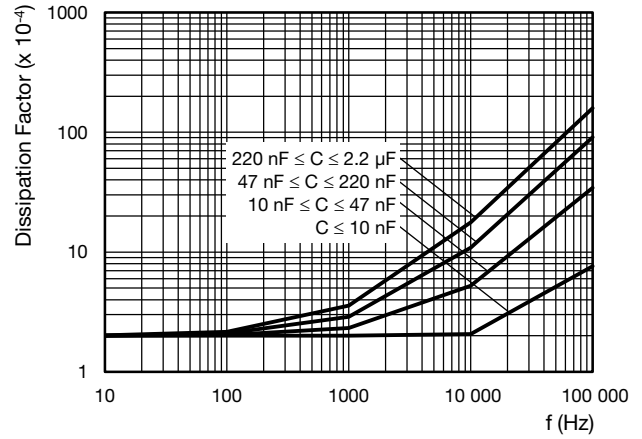

Tangent of loss angle as a function of frequency (typical curve)

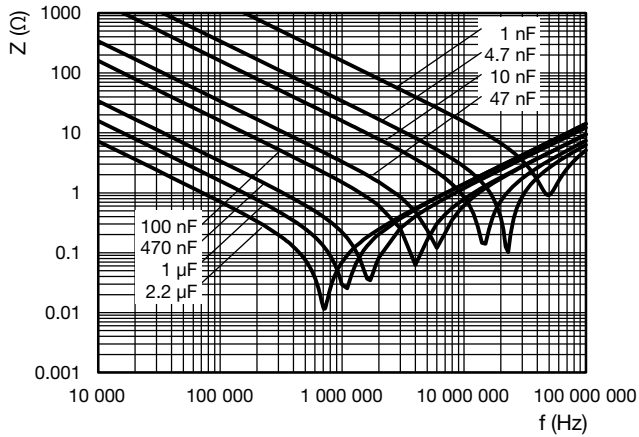

Impedance as a function of frequency (typical curve)



Resonant frequency as a function of capacitance (typical curve)

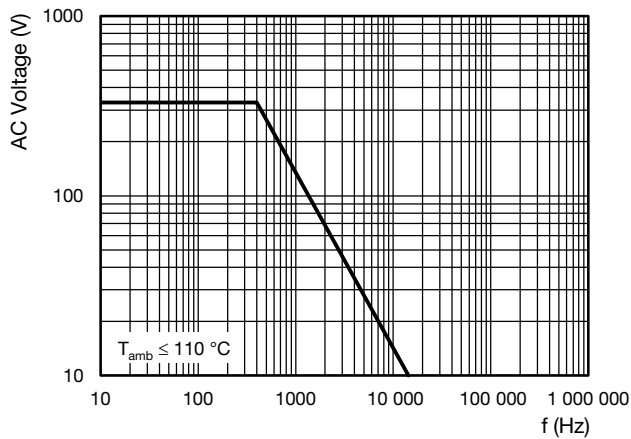

Max. RMS voltage as a function of frequency

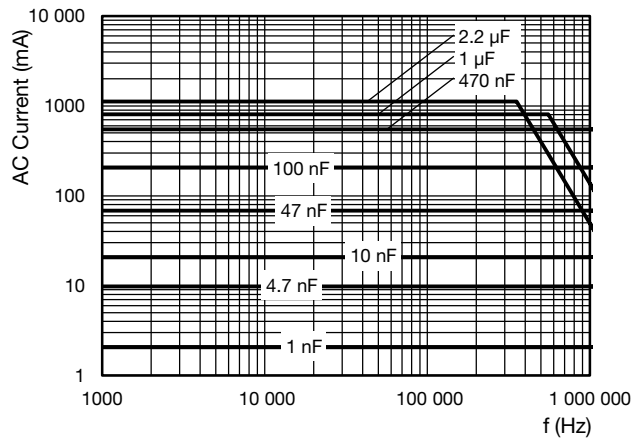

Max. RMS current as a function of frequency

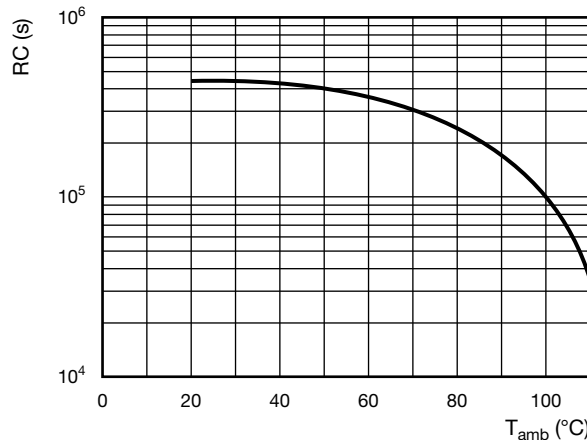

Insulation resistance as a function of ambient temperature
(typical curve)

APPLICATION NOTES

- For X1 electromagnetic interference suppression in **standard across the line applications** (50 Hz/60 Hz) with a maximum mains voltage of 330 V_{AC}
- For series impedance applications we refer to the application note: www.vishay.com/doc?28153
- For capacitors connected in parallel, normally the proof voltage and possibly the rated voltage must be reduced. For information depending of the capacitance value and the number of parallel connections contact: rfi@vishay.com
- These capacitors are not intended for continuous pulse applications. For these situations, capacitors of the AC and pulse programs must be used.
- The maximum ambient temperature must not exceed 110 °C.
- Rated voltage pulse slope:
if the pulse voltage is lower than the rated voltage, the values of the specific reference data can be multiplied by 465 V_{DC} and divided by the applied voltage.

INSPECTION REQUIREMENTS

General Notes

Sub-clause numbers of tests and performance requirements refer to the “Sectional Specification, Publication IEC 60384-14 ed-3 and Specific Reference Data”.

GROUP C INSPECTION REQUIREMENTS		
SUB-CLAUSE NUMBER AND TEST	CONDITIONS	PERFORMANCE REQUIREMENTS
SUB-GROUP C-1A PART OF SAMPLE OF SUB-GROUP C-1		
4.1 Dimensions (detail)		As specified in chapters “General Data” of this specification
Initial measurements	Capacitance Tangent of loss angle at 10 kHz for C ≤ 1 μF Tangent of loss angle at 1 kHz for C > 1 μF	
4.3 Robustness of terminations	Tensile: load 10 N; 10 s Bending: load 5 N; 4 x 90°	No visible damage
4.4 Resistance to soldering heat	No pre-drying Method: 1A Solder bath: 280 °C ± 5 °C Duration: 10 s	



GROUP C INSPECTION REQUIREMENTS		
SUB-CLAUSE NUMBER AND TEST	CONDITIONS	PERFORMANCE REQUIREMENTS
SUB-GROUP C1A PART OF SAMPLE OF SUB-GROUP C1		
4.19 Component solvent resistance	Isopropylalcohol at room temperature Method: 2 Immersion time: 5 min ± 0.5 min Recovery time: min. 1 h, max. 2 h	
4.4.2 Final measurements	Visual examination Capacitance Tangent of loss angle Insulation resistance	No visible damage Legible marking $ \Delta C/C \leq 5\%$ of the value measured initially Increase of $\tan \delta \leq 0.008$ for $\leq 1 \mu\text{F}$ Increase of $\tan \delta \leq 0.005$ for $C > 1 \mu\text{F}$ Compared to values measured initially As specified in section "Insulation Resistance" of this specification
SUB-GROUP C1B OTHER PART OF SAMPLE OF SUB-GROUP C1		
Initial measurements	Capacitance Tangent of loss angle at 10 kHz for $C \leq 1 \mu\text{F}$ Tangent of loss angle at 1 kHz for $C > 1 \mu\text{F}$	
4.20 Solvent resistance of the marking	Isopropyl alcohol at room temperature Method: 1 Rubbing material: cotton wool Immersion time: 5 min ± 0.5 min	No visible damage Legible marking
4.6 Rapid change of temperature	$\theta A = -55^\circ\text{C}$ $\theta B = +110^\circ\text{C}$ 5 cycles Duration $t = 30$ min	
4.6.1 Inspection	Visual examination	No visible damage
4.7 Vibration	Mounting: see section "Mounting" of this specification Procedure B4: frequency range: 10 Hz to 55 Hz Amplitude: 0.75 mm or Acceleration 98 m/s^2 (whichever is less severe) Total duration 6 h	
4.7.2 Final inspection	Visual examination	No visible damage
4.9 Shock	Mounting: see section "Mounting" for more information Pulse shape: half sine Acceleration: 490 m/s^2 Duration of pulse: 11 ms	
4.9.2 Final measurements	Visual examination Capacitance Tangent of loss angle Insulation resistance	No visible damage $ \Delta C/C \leq 5\%$ of the value measured initially Increase of $\tan \delta \leq 0.008$ for $\leq 1 \mu\text{F}$ Increase of $\tan \delta \leq 0.005$ for $C > 1 \mu\text{F}$ Compared to values measured initially As specified in section "Insulation Resistance" of this specification



GROUP C INSPECTION REQUIREMENTS		
SUB-CLAUSE NUMBER AND TEST	CONDITIONS	PERFORMANCE REQUIREMENTS
SUB-GROUP C1 COMBINED SAMPLE OF SPECIMENS OF SUB-GROUPS C1A AND C1B		
4.11 Climatic sequence		
4.11.1 Initial measurements	Capacitance Measured in 4.4.2 and 4.9.2 Tangent of loss angle: measured initially in C1A and C1B	
4.11.2 Dry heat	Temperature: 110 °C	
4.11.3 Damp heat cyclic Test Db First cycle	Duration: 16 h	
4.11.4 Cold	Temperature: -55 °C	
4.11.5 Damp heat cyclic Test Db remaining cycles	Duration: 2 h	
4.11.6 Final measurements	Visual examination Capacitance Tangent of loss angle Voltage proof 1900 V _{DC} ; 1 min between terminations Insulation resistance	No visible damage Legible marking $ \Delta C/C \leq 5\%$ of the value measured in 4.11.1. Increase of $\tan \delta \leq 0.008$ for $\leq 1 \mu\text{F}$ Increase of $\tan \delta \leq 0.005$ for $C > 1 \mu\text{F}$ Compared to values measured in 4.11.1 No permanent breakdown or flash-over $\geq 50\%$ of values specified in section "Insulation Resistance" of this specification
SUB-GROUP C2		
4.12 Damp heat steady state	56 days, 40 °C, 90 % to 95 % RH, no load	
4.12.1 Initial measurements	Capacitance Tangent of loss angle at 1 kHz	
4.12.3 Final measurements	Visual examination Capacitance Tangent of loss angle Voltage proof 1900 V _{DC} ; 1 min between terminations Insulation resistance	No visible damage Legible marking $ \Delta C/C \leq 5\%$ of the value measured in 4.12.1. Increase of $\tan \delta \leq 0.008$ Compared to values measured in 4.12.1. No permanent breakdown or flash-over $\geq 50\%$ of values specified in section "Insulation Resistance" of this specification

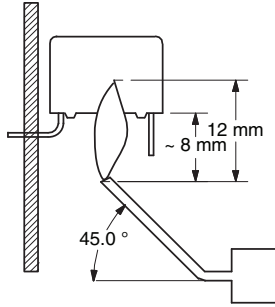

GROUP C INSPECTION REQUIREMENTS		
SUB-CLAUSE NUMBER AND TEST	CONDITIONS	PERFORMANCE REQUIREMENTS
SUB-GROUP C3		
4.13.1 Initial measurements	Capacitance Tangent of loss angle at 10 kHz for $C \leq 1 \mu\text{F}$ Tangent of loss angle at 1 kHz for $C > 1 \mu\text{F}$	
4.13 Impulse voltage	3 successive impulses, full wave, peak voltage: X1: 4.0 kV for $C \leq 1 \mu\text{F}$ X1: 4.0 kV/ \sqrt{C} for $C > 1 \mu\text{F}$ Max. 24 pulses	No self healing breakdowns or flash-over
4.14 Endurance	Duration: 1000 h 1.25 x U_{RAC} at 110 °C Once in every hour the voltage is increased to 1000 V_{RMS} for 0.1 s via resistor of 47 $\Omega \pm 5 \%$	
4.14.7 Final measurements	Visual examination Capacitance Tangent of loss angle Voltage proof 1900 V_{DC} ; 1 min between terminations 2160 V_{AC} ; 1 min between terminations and case Insulation resistance	No visible damage Legible marking $ \Delta C/C \leq 10 \%$ compared to values measured in 4.13.1. Increase of $\tan \delta \leq 0.008$ for $\leq 1 \mu\text{F}$ Increase of $\tan \delta \leq 0.005$ for $C > 1 \mu\text{F}$ Compared to values measured in 4.13.1 No permanent breakdown or flash-over $\geq 50 \%$ of values specified in section "Insulation Resistance" of this specification
SUB-GROUP C4		
4.15 Charge and discharge	10 000 cycles charged to 465 V_{DC} Discharge resistance: $R_{min.} = 2.2 \Omega$ for pitch 37.5 mm and 52.5 mm $R = \frac{465 V_{DC}}{1.5 \times C (dU/dt)}$	
4.15.1 Initial measurements	Capacitance Tangent of loss angle at 10 kHz for $C \leq 1 \mu\text{F}$ Tangent of loss angle at 1 kHz for $C > 1 \mu\text{F}$	
4.15.3 Final measurements	Capacitance Tangent of loss angle Insulation resistance	$ \Delta C/C \leq 10 \%$ compared to values measured in 4.15.1. Increase of $\tan \delta \leq 0.008$ for $\leq 1 \mu\text{F}$ Increase of $\tan \delta \leq 0.005$ for $C > 1 \mu\text{F}$ Compared to values measured in 4.15.1 $\geq 50 \%$ of values specified in section "Insulation Resistance" of this specification

GROUP C INSPECTION REQUIREMENTS		
SUB-CLAUSE NUMBER AND TEST	CONDITIONS	PERFORMANCE REQUIREMENTS
SUB-GROUP C5		
4.16 Radio frequency characteristic	Resonance frequency	≥ 0.9 times the value as specified in section "Resonant Frequency" of this specification
SUB-GROUP C6		
4.17 Passive flammability Class B	Bore of gas jet: $\varnothing 0.5$ mm Fuel: butane Test duration for actual volume V in mm^3 : $V \leq 250$: 10 s $250 < V \leq 500$: 20 s $500 < V \leq 1750$: 30 s $V > 1750$: 60 s One flame application 	After removing test flame from capacitor, the capacitor must not continue to burn for more than 10 s. No burning particle must drop from the sample.
SUB-GROUP C7		
4.18 Active flammability	20 cycles of 4 kV discharges on the test capacitor connected to U_{RAC}	The cheese cloth around the capacitors shall not burn with a flame. No electrical measurements are required.



Disclaimer

ALL PRODUCT, PRODUCT SPECIFICATIONS AND DATA ARE SUBJECT TO CHANGE WITHOUT NOTICE TO IMPROVE RELIABILITY, FUNCTION OR DESIGN OR OTHERWISE.

Vishay Intertechnology, Inc., its affiliates, agents, and employees, and all persons acting on its or their behalf (collectively, "Vishay"), disclaim any and all liability for any errors, inaccuracies or incompleteness contained in any datasheet or in any other disclosure relating to any product.

Vishay makes no warranty, representation or guarantee regarding the suitability of the products for any particular purpose or the continuing production of any product. To the maximum extent permitted by applicable law, Vishay disclaims (i) any and all liability arising out of the application or use of any product, (ii) any and all liability, including without limitation special, consequential or incidental damages, and (iii) any and all implied warranties, including warranties of fitness for particular purpose, non-infringement and merchantability.

Statements regarding the suitability of products for certain types of applications are based on Vishay's knowledge of typical requirements that are often placed on Vishay products in generic applications. Such statements are not binding statements about the suitability of products for a particular application. It is the customer's responsibility to validate that a particular product with the properties described in the product specification is suitable for use in a particular application. Parameters provided in datasheets and / or specifications may vary in different applications and performance may vary over time. All operating parameters, including typical parameters, must be validated for each customer application by the customer's technical experts. Product specifications do not expand or otherwise modify Vishay's terms and conditions of purchase, including but not limited to the warranty expressed therein.

Except as expressly indicated in writing, Vishay products are not designed for use in medical, life-saving, or life-sustaining applications or for any other application in which the failure of the Vishay product could result in personal injury or death. Customers using or selling Vishay products not expressly indicated for use in such applications do so at their own risk. Please contact authorized Vishay personnel to obtain written terms and conditions regarding products designed for such applications.

No license, express or implied, by estoppel or otherwise, to any intellectual property rights is granted by this document or by any conduct of Vishay. Product names and markings noted herein may be trademarks of their respective owners.