

# EPIC® CIRCON LS1

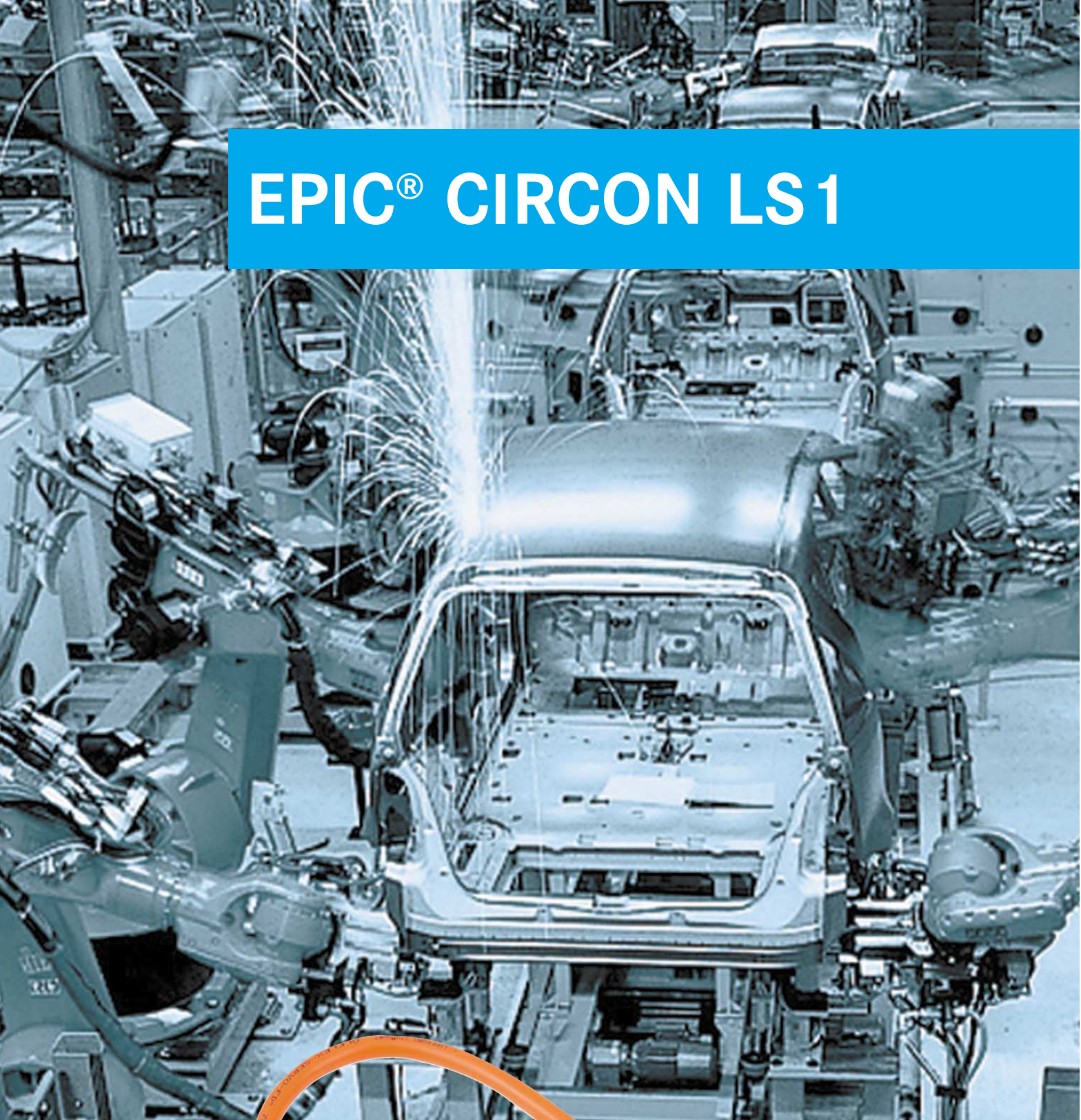

**CONTACT**  
Connectors 



A Lapp Group Company

EPIC® CIRCON LS 1 – Power Circular Connector – with:

For further information, please send us an e-mail to [contact@contactconnectors.de](mailto:contact@contactconnectors.de)

- Protection class: IP 68 (5 bar)
- Unique marking system:
  - a) by means of coloured marking clips or alternatively
  - b) by individual markable labels
- Clear visible and tangible guidance when mating
- Circular connectors according to DIN EN 61984

## EPIC® CIRCON LS1 Power Circular Connector



### Technical data 5 + GND

Rated current 2 mm contacts: 22 A	Pollution degree: 3 (≥ IP 54)
Rated voltage 2 mm contacts: 630 V	Overvoltage category: 3
Impulse rated voltage 2 mm contacts: 6 kV	Cross sections: 0,5-2,5 mm <sup>2</sup> Crimp AWG 14-20 Crimp

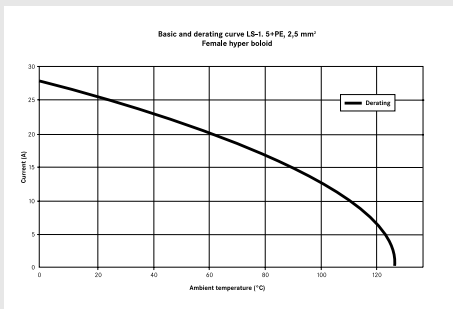

### Technical data 3 + GND + 4

Rated current 1 mm contacts: 7 A at 1,0 mm <sup>2</sup>	Impulse rated voltage 2 mm contacts: 6 kV
Rated current 2 mm contacts: 22 A at 2,5 mm <sup>2</sup>	Pollution degree: 3 (≥ IP54)
Rated voltage 1 mm contacts: 250 V	Overvoltage category: 3
Rated voltage 2 mm contacts: 630 V	Cross sections 1 mm contacts: 0,14-1,0 mm <sup>2</sup> Crimp AWG 18-24 Crimp
Impulse rated voltage 1 mm contacts: 4 kV	Cross sections 2 mm contacts: 0,5-2,5 mm <sup>2</sup> Crimp AWG 14-20 Crimp

Protection class: IP 68 – 5 bar	Temperature range: -25 °C to +125 °C	Mating cycles: 500	Cable clamping range: 7,5-15,5 mm	Resistance: Corrosion resistant Mechanical resistant
------------------------------------	---	-----------------------	--------------------------------------	--



Part No.:	Part	Poles	Packing unit				
76003000	LS1 A1 5+PE K (5) PANEL MOUNT BASE WITH MALE CONTACTS	5+PE	5				
76123100	LS1 D6 5+PE K 7,5-15,5 SHORT (5) CABLE CONNECTOR WITH FEMALE CONTACTS	5+PE	5				
76123000	LS1 D6 5+PE K 7,5-15,5 (5) CABLE CONNECTOR WITH FEMALE CONTACTS	5+PE	5				
76133000	LS1 F6 5+PE K 7,5-15,5 (5) CABLE COUPLER WITH MALE CONTACTS	5+PE	5				
76143000	LS1 F7 5+PE K 7,5-15,5 (5) CABLE COUPLER WITH MALE CONTACTS	5+PE	5				

Part No.:	Part	Poles	Packing unit				
76004000	LS1 A1 3+PE+4 K (5) PANEL MOUNT BASE WITH MALE CONTACTS	3+PE+4	5				
76124100	LS1 D6 3+PE+4 K 7,5-15,5 SHORT (5) CABLE CONNECTOR WITH FEMALE CONTACTS	3+PE+4	5				
76124000	LS1 D6 3+PE+4 K 7,5-15,5 (5) CABLE CONNECTOR WITH FEMALE CONTACTS	3+PE+4	5				
76134000	LS1 F6 3+PE+4 K 7,5-15,5 (5) CABLE COUPLER WITH MALE CONTACTS	3+PE+4	5				
76144000	LS1 F7 3+PE+4 K 7,5-15,5 (5) CABLE COUPLER WITH MALE CONTACTS	3+PE+4	5				

## CONTACTS

Part No.:	Part	Type	For model	Packing unit
74033001	LS1 A SCEM 1 mm AU 0,14-1,0 (10) Male contact	1 mm male	A1	10
74033101	LS1 A SCEM 2 mm AU 0,5-2,5 (10) Male contact	2 mm male	A1	10
74033501	LS1 D BCEMS 1 mm AU 0,14-1,0 (10) Female contact	1 mm female slot	D6	10
74034501	LS1 D BCEMD 1 mm AU 0,14-1,0 (10) Female contact	1 mm female hyper boloid	D6	10
74034601	LS1 D BCEMD 2 mm AU 1,0-2,5 (10) Female contact	2 mm female hyper boloid	D6	10
74034001	LS1 F SCEM 1 mm AU 0,14-1,0 (10) Male contact	1 mm male	F6/F7	10
74034101	LS1 F SCEM 2 mm AU 0,5-2,5 (10) Male contact	2 mm male	F6/F7	10

## CRIMPING TOOLS

Part No.:	Part	Remark	Packing unit	
11148000	CRIMPING TOOL 0.14-6.0 mm <sup>2</sup>	with service case	1	
11148300	LOCATOR FOR EPIC® CIRCON LS1		1	

## REMOVAL TOOLS

Part No.:	Part	for model	Packing unit
75017400	LS1 REMOVAL TOOL F,1MM CONTACT	A1	1
75017500	LS1 REMOVAL TOOL F,2MM CONTACT	A1	1

## ACCESSORIES

Part No.:	Part	Remark	Packing unit
75018210	LS1 A (20) SCREW CAP	Metal screw cap for A1	20
75018310	LS1 A,G,F (20) SCREW CAP M.F.	Metal screw cap for A1, F6, F7	20
75007710	LS1 D (20) PROTECTION CAP	Plastic protection cap for D6	20
75007810	LS1 A,B,F,G (20) PROTECTION CAP	Plastic protection cap for A1, F6, F7	20

## ACCESSORIES (MARKING SYSTEM)

Part No.:	Part	Packing unit	
61800250	ILP 219 INDUSTRY DYMO MARKING SYSTEM	1	
61800260	ID1 9 MM POLYESTER BW/WB 18766	1	
61800263	ID1 9 MM POLYESTER BW/METAL 18760 1	1	

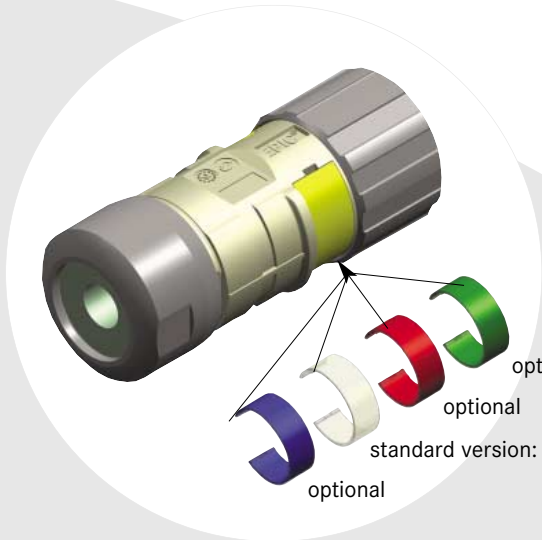

The marking rings can be supplied in other colors upon request.



**EPIC® CIRCON LS 1 –  
new ideas in new design**

- Circular connector with the unique marking field. The DYMO marking system provides easy handling. The labels cannot be erased and cannot be lost
- Large cable clamping range of 7.5-15.5 mm. One circular connector for many different cable diameters
- With integrated EMC screen
- Protection class: IP 68 – highest protection against the penetration of dust and water
- Corrosion-tested; for use in rough environment
- Vibration-tested; perfectly suitable for electric drives and moving parts

Please contact our sales hotline:  
+49/(0) 7 11/78 38-64 00 for further information. We look forward to meeting your requirements and making you a personalized offer.

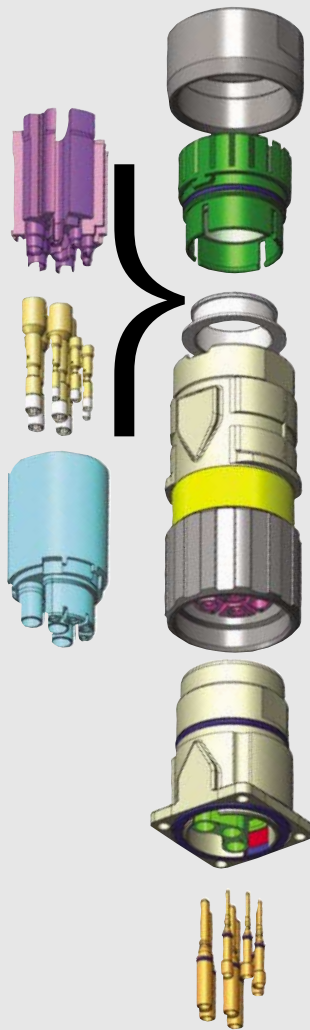

**Marking recommendation for  
EPIC® CIRCON LS 1 circular connector:  
DYMO Marking System ILP 219**

- Easy production & simple PC handling of the marking labels with new ILP software
- Accurately adapted labeling field by label mode "fixed length"
- Improved durability of the labels through extra strong adhesive



**Contact GmbH**

Gewerbestraße 30  
D-70565 Stuttgart  
Tel: +49/(0)7 11/78 38-03  
Fax: +49/(0)7 11/78 38-38 80  
contact@contactconnectors.de  
www.contactconnectors.de

**ÖLFLEX® Connection  
and control cables**

ÖLFLEX® is used in machinery, machine tools, system and appliance engineering, measuring, control, heating and air conditioning technologies. For permanent connections or in cable chains, halogen-free or internationally certified, you can choose from our comprehensive range of standard products.