

# Operating Instructions

## Cerabar PMC11, PMC21, PMP11, PMP21, PMP23

Process pressure measurement  
Pressure transducer for safe measurement and  
monitoring of absolute and gauge pressure





A0023555

- Make sure the document is stored in a safe place such that it is always available when working on or with the device.
- To avoid danger to individuals or the facility, read the "Basic safety instructions" section carefully, as well as all other safety instructions in the document that are specific to working procedures.
- The manufacturer reserves the right to modify technical data without prior notice. Your Endress+Hauser distributor will supply you with current information and updates to these Instructions.

## Table of contents

<b>1</b>	<b>About this document</b> .....	<b>4</b>	<b>9</b>	<b>Maintenance</b> .....	<b>25</b>
1.1	Document function .....	4	9.1	Exterior cleaning .....	26
1.2	Symbols used .....	4	<b>10</b>	<b>Repair</b> .....	<b>27</b>
1.3	Documentation .....	5	10.1	General information .....	27
1.4	Terms and abbreviations .....	6	10.2	Return .....	27
1.5	Turn down calculation .....	6	10.3	Disposal .....	27
<b>2</b>	<b>Basic safety instructions</b> .....	<b>8</b>	<b>11</b>	<b>Accessories</b> .....	<b>28</b>
2.1	Requirements concerning the staff .....	8	11.1	Weld-in adapter .....	28
2.2	Designated use .....	8	11.2	Process adapter M24 .....	28
2.3	Workplace safety .....	9	11.3	Plug-on display PHX20 .....	29
2.4	Operational safety .....	9	11.4	M12 plug connectors .....	29
2.5	Product safety .....	9	<b>12</b>	<b>Technical data</b> .....	<b>31</b>
<b>3</b>	<b>Product description</b> .....	<b>10</b>	12.1	Input .....	31
3.1	Product design .....	10	12.2	Output .....	35
3.2	Function .....	11	12.3	Performance characteristics of ceramic process isolating diaphragm .....	37
<b>4</b>	<b>Incoming acceptance and product identification</b> .....	<b>12</b>	12.4	Performance characteristics of metal process isolating diaphragm .....	39
4.1	Incoming acceptance .....	12	12.5	Environment .....	41
4.2	Product identification .....	13	12.6	Process .....	43
4.3	Storage and transport .....	14	<b>Index</b> .....	<b>45</b>	
<b>5</b>	<b>Installation</b> .....	<b>15</b>			
5.1	Mounting dimensions .....	15			
5.2	Installation conditions .....	15			
5.3	Influence of the installation position .....	15			
5.4	Mounting location .....	16			
5.5	Mounting of the profile seal for universal process mounting adapter .....	17			
5.6	Mounting instructions for oxygen applications .....	17			
5.7	Post-installation check .....	18			
<b>6</b>	<b>Electrical connection</b> .....	<b>19</b>			
6.1	Connecting the measuring unit .....	19			
6.2	Switching capacity .....	21			
6.3	Connection conditions .....	21			
6.4	Connection data .....	21			
6.5	Post-connection check .....	21			
<b>7</b>	<b>Operation options</b> .....	<b>22</b>			
7.1	Plug-on display PHX20 (optional) .....	22			
<b>8</b>	<b>Diagnostics and troubleshooting</b> ...	<b>25</b>			
8.1	Troubleshooting .....	25			
8.2	Response of output to errors .....	25			
8.3	Disposal .....	25			

# 1 About this document

## 1.1 Document function

These Operating Instructions contain all the information that is required in various phases of the life cycle of the device: from product identification, incoming acceptance and storage, to mounting, connection, operation and commissioning through to troubleshooting, maintenance and disposal.

## 1.2 Symbols used

### 1.2.1 Safety symbols

** DANGER**

This symbol alerts you to a dangerous situation. Failure to avoid this situation will result in serious or fatal injury.

** WARNING**

This symbol alerts you to a dangerous situation. Failure to avoid this situation can result in serious or fatal injury.

** CAUTION**

This symbol alerts you to a dangerous situation. Failure to avoid this situation can result in minor or medium injury.

**NOTICE**

This symbol contains information on procedures and other facts which do not result in personal injury.

### 1.2.2 Electrical symbols

**Protective ground connection: **

A terminal which must be connected to ground prior to establishing any other connections.

**Ground connection: **

Terminal for connection to the grounding system.

### 1.2.3 Tool symbols

**Open-ended wrench: **

### 1.2.4 Symbols for certain types of information

**Permitted: **

Procedures, processes or actions that are permitted.

**Forbidden: **

Procedures, processes or actions that are forbidden.

**Additional information:** 

**Reference to documentation:** 

**Reference to page:** 

**Series of steps:** [1](#), [2](#), [3](#)

**Result of an individual step:** 

### 1.2.5 Symbols in graphics

**Item numbers:** 1, 2, 3 ...

**Series of steps:** [1](#), [2](#), [3](#)

**Views:** A, B, C, ...

## 1.3 Documentation

 The document types listed are available:  
In the Download Area of the Endress+Hauser Internet site: [www.endress.com](http://www.endress.com) →  
Download

### 1.3.1 Technical Information (TI): planning aid for your device

PMC11: TI01133P

PMP11: TI01133P

PMC21: TI01133P

PMP21: TI01133P

PMP23: TI01203P

The document contains all the technical data on the device and provides an overview of the accessories and other products that can be ordered for the device.

### 1.3.2 Brief Operating Instructions (KA): getting the 1st measured value quickly

KA01164P

These instructions contain all the essential information from incoming acceptance to initial commissioning.

### 1.3.3 Safety Instructions (XA)

Safety Instructions (XA) are supplied with the device depending on the approval. They are an integral part of the Operating Instructions.

 The nameplate indicates the Safety Instructions (XA) that are relevant to the device.

## 1.4 Terms and abbreviations

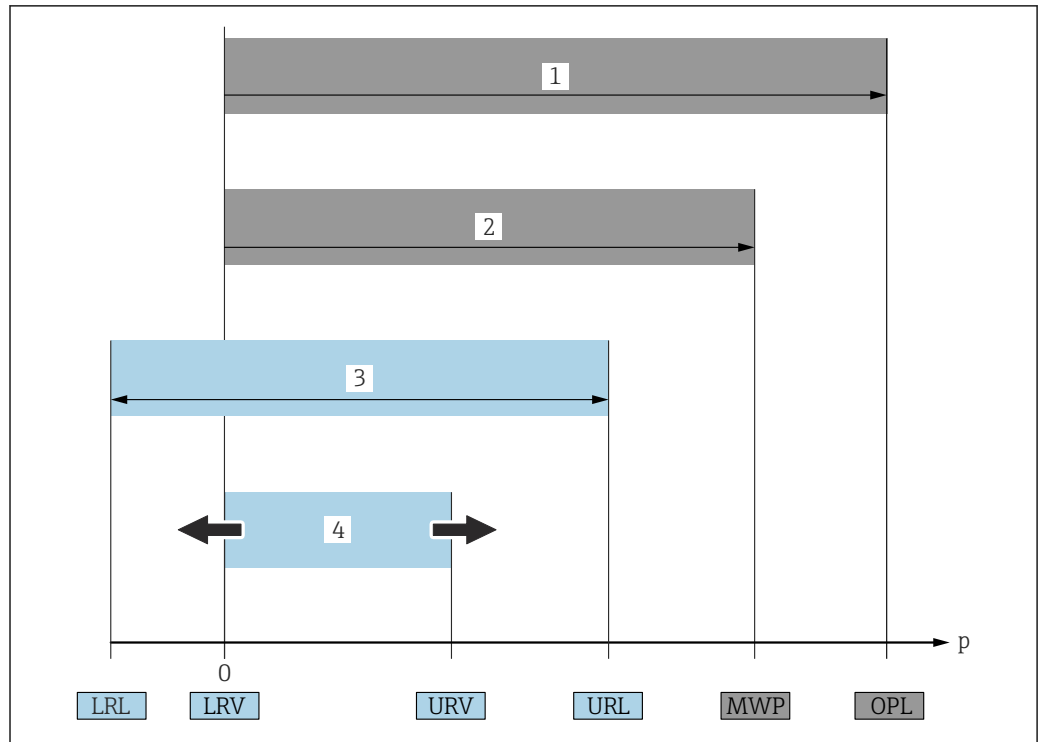

A0029505

- 1 OPL: The OPL (over pressure limit = sensor overload limit) for the measuring device depends on the lowest-rated element, with regard to pressure, of the selected components, i.e. the process connection has to be taken into consideration in addition to the measuring cell. Pay attention to the pressure/temperature dependency. The OPL may only be applied for a short period of time.
  - 2 MWP: The MWP (maximum working pressure) for the sensors depends on the lowest-rated element, with regard to pressure, of the selected components, i.e. the process connection has to be taken into consideration in addition to the measuring cell. Pay attention to the pressure/temperature dependency. The MWP may be applied at the device for an unlimited period. The MWP can be found on the nameplate.
  - 3 The maximum sensor measuring range corresponds to the span between the LRL and URL. This sensor measuring range is equivalent to the maximum calibratable/adjustable span.
  - 4 The calibrated/adjusted span corresponds to the span between the LRV and URV. Factory setting: 0 to URL. Other calibrated spans can be ordered as customized spans.
- p Pressure  
 LRL Lower range limit  
 URL Upper range limit  
 LRV Lower range value  
 URV Upper range value  
 TD Turn down. Example - see the following section.

The turn down is preset at the factory and cannot be changed.

## 1.5 Turn down calculation

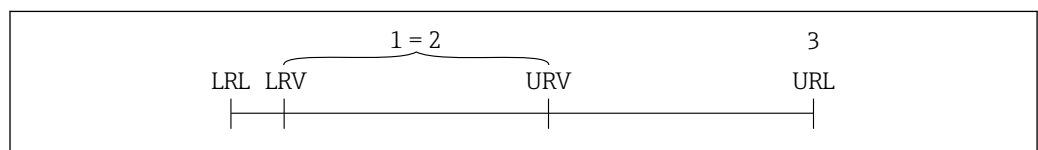

A0029545

- 1 Calibrated/adjusted span
- 2 Zero point-based span
- 3 Upper range limit

**Example**

- Sensor: 10 bar (150 psi)
- Upper range limit (URL) = 10 bar (150 psi)
- Turn down (TD):
- Calibrated/adjusted span: 0 to 5 bar (0 to 75 psi)
- Lower range value (LRV) = 0 bar (0 psi)
- Upper range value (URV) = 5 bar (75 psi)

$$TD = \frac{URL}{|URV - LRV|}$$
$$TD = \frac{10 \text{ bar (150 psi)}}{|5 \text{ bar (75 psi)} - 0 \text{ bar (0 psi)}|} = 2$$

In this example, the TD is 2:1.  
This span is based on the zero point.

## 2 Basic safety instructions

### 2.1 Requirements concerning the staff

The personnel for installation, commissioning, diagnostics and maintenance must fulfill the following requirements:

- ▶ Trained, qualified specialists: must have a relevant qualification for this specific function and task
- ▶ Are authorized by the plant owner/operator
- ▶ Are familiar with federal/national regulations
- ▶ Before beginning work, the specialist staff must have read and understood the instructions in the Operating Instructions and supplementary documentation as well as in the certificates (depending on the application)
- ▶ Following instructions and basic conditions

The operating personnel must fulfill the following requirements:

- ▶ Being instructed and authorized according to the requirements of the task by the facility's owner-operator
- ▶ Following the instructions in these Operating Instructions

### 2.2 Designated use

#### 2.2.1 Application and media

The Cerabar is used to measure absolute and gauge pressure in gases, vapors and liquids. The process-wetted materials of the measuring device must have an adequate level of resistance to the media.

The measuring device may be used for the following measurements (process variables)

- in compliance with the limit values specified under "Technical data"
- in compliance with the conditions that are listed in additional documentation such as the XA and this manual.

#### Measured process variable

- PMC11: Gauge pressure
- PMP11: Gauge pressure
- PMC21: Gauge pressure or absolute pressure
- PMP21: Gauge pressure or absolute pressure
- PMP23: Gauge pressure or absolute pressure

#### Calculated process variable

Pressure

#### 2.2.2 Incorrect use

The manufacturer is not liable for damage caused by improper or non-designated use.

Verification for borderline cases:

- ▶ For special fluids and fluids for cleaning, Endress+Hauser is glad to provide assistance in verifying the corrosion resistance of process-wetted materials, but does not accept any warranty or liability.

#### 2.2.3 Residual risks

When in operation, the housing may reach a temperature close to the process temperature.



Danger of burns from contact with surfaces!

- ▶ For elevated process temperatures, ensure protection against contact to prevent burns.

## 2.3 Workplace safety

For work on and with the device:

- ▶ Wear the required personal protective equipment according to federal/national regulations.
- ▶ Switch off the supply voltage before connecting the device.

## 2.4 Operational safety

Risk of injury!

- ▶ Operate the device in proper technical condition and fail-safe condition only.
- ▶ The operator is responsible for interference-free operation of the device.

### Conversions to the device

Unauthorized modifications to the device are not permitted and can lead to unforeseeable dangers.

- ▶ If, despite this, modifications are required, consult with Endress+Hauser.

### Hazardous area

To eliminate the risk of danger to persons or the facility when the device is used in the approval-related area (e.g. explosion protection, pressure equipment safety):

- ▶ Check the nameplate to verify if the device ordered can be put to its intended use in the approval-related area.
- ▶ Observe the specifications in the separate supplementary documentation, such as the XA or SD, which is an integral part of these Instructions.

## 2.5 Product safety

This measuring device is designed in accordance with good engineering practice to meet state-of-the-art safety requirements, has been tested, and left the factory in a condition in which it is safe to operate.

It meets general safety standards and legal requirements. It also complies with the EU directives listed in the device-specific EU Declaration of Conformity. Endress+Hauser confirms this by affixing the CE mark to the device.

### 3 Product description

#### 3.1 Product design

Overview	Item	Description
	A	Valve plug
	B	Cable
	C- 1	M12 plug Housing cap made of plastic
	C- 2	M12 plug For Ex ec and IP69: metal housing cap Metal housing cap can also be ordered as an option.
	D	Housing
	E	Process connection (sample illustration)
	D	
	E	

## 3.2 Function

### 3.2.1 Calculating the pressure

#### **Devices with ceramic process isolating diaphragm (Ceraphire®)**

The ceramic sensor is an oil-free sensor, i.e. the process pressure acts directly on the robust ceramic process isolating diaphragm and causes it to deflect. A pressure-dependent change in capacitance is measured at the electrodes of the ceramic substrate and the process isolating diaphragm. The measuring range is determined by the thickness of the ceramic process isolating diaphragm.

#### **Devices with metallic process isolating diaphragm**

The process pressure deflects the metal process isolating diaphragm of the sensor and a fill fluid transfers the pressure to a Wheatstone bridge (semiconductor technology). The pressure-dependent change in the bridge output voltage is measured and evaluated.

# 4 Incoming acceptance and product identification

## 4.1 Incoming acceptance

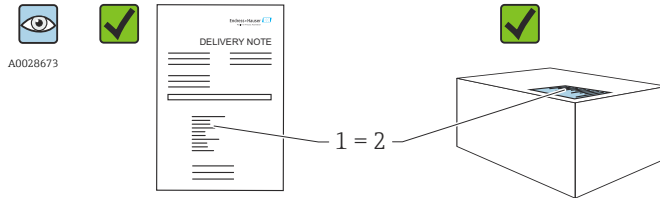

A0016870

Is the order code on the delivery note (1) identical to the order code on the product sticker (2)?

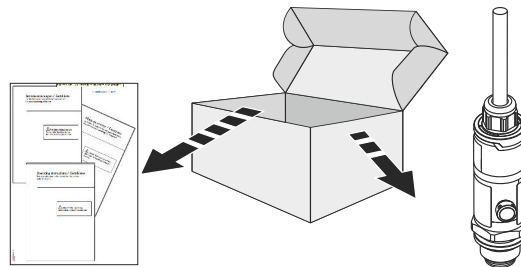

A0022100

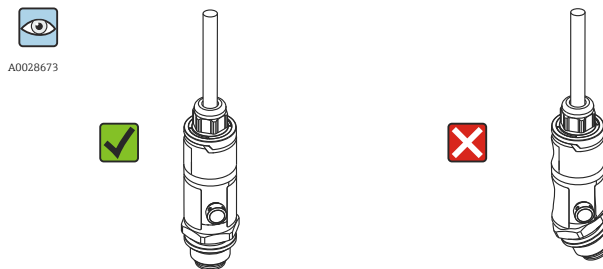

A0022103

Are the goods undamaged?

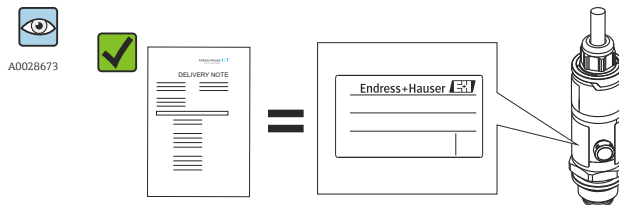

A0022105

Do the data on the nameplate correspond to the order specifications and the delivery note?

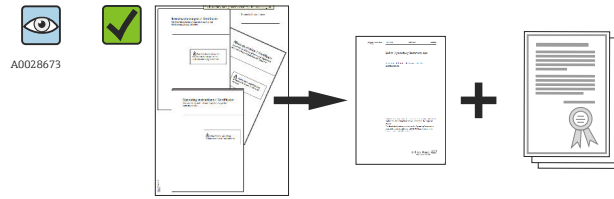

A0022106

Is the documentation available?

If required (see nameplate): Are the safety instructions (XA) provided?

**i** If one of these conditions does not apply, please contact your Endress+Hauser sales office.

## 4.2 Product identification

The following options are available for the identification of the measuring device:

- Nameplate specifications
- Order code with a breakdown of the device features on the delivery note
- Enter the serial numbers from the nameplates in *W@M Device Viewer* ([www.endress.com/deviceviewer](http://www.endress.com/deviceviewer)): All the information about the measuring device is displayed.

For an overview of the technical documentation provided, enter the serial number from the nameplates in *W@M Device Viewer* ([www.endress.com/deviceviewer](http://www.endress.com/deviceviewer))

### 4.2.1 Manufacturer address

Endress+Hauser SE+Co. KG  
 Hauptstraße 1  
 79689 Maulburg, Germany  
 Place of manufacture: See nameplate.

### 4.2.2 Nameplate

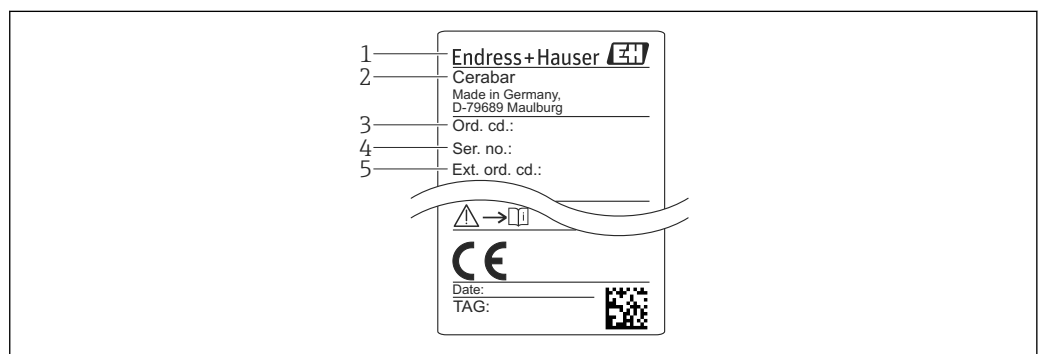

A0024456

- 1 *Manufacturer's address*
- 2 *Device name*
- 3 *Order number*
- 4 *Serial number*
- 5 *Extended order number*

## 4.3 Storage and transport

### 4.3.1 Storage conditions

Use original packaging.

Store the measuring device in clean and dry conditions and protect from damage caused by shocks (EN 837-2).

#### Storage temperature range

-40 to +85 °C (-40 to +185 °F)

### 4.3.2 Transporting the product to the measuring point

#### **WARNING**

##### **Incorrect transport!**

Housing and diaphragm may become damaged, and there is a risk of injury!

- ▶ Transport the measuring device to the measuring point in its original packaging or by the process connection.

## 5 Installation

### 5.1 Mounting dimensions

For dimensions, see the "Mechanical construction" section in the Technical Information.

### 5.2 Installation conditions

- Moisture must not penetrate the housing when mounting the device, establishing the electrical connection and during operation.
- For M12 plug made of metal: Do not remove the protection cap (only in IP69 and Ex ec version) of M12 plug connection until shortly before electrical connection.
- Do not clean or touch process isolating diaphragms with hard and/or pointed objects.
- Do not remove process isolating diaphragm protection until shortly before installation.
- Always tighten the cable entry firmly.
- Point the cable and connector downwards where possible to prevent moisture from entering (e.g. rain or condensation water).
- Protect housing against impact.
- For devices with gauge pressure sensor and M12 or valve plug, the following applies:

#### NOTICE

**If a heated device is cooled in the course of a cleaning process (by cold water, for example), a vacuum develops for a short time causing moisture to penetrate the sensor via the pressure compensation element (1).**

Device could be destroyed!

- ▶ In the event of this happening, mount the device in such a way that the pressure compensation element (1) is pointing downwards at an angle or to the side, if possible.

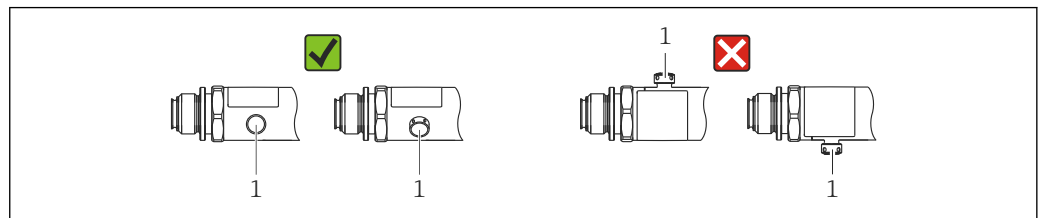

A0022252

### 5.3 Influence of the installation position

Any orientation is possible. However, the orientation may cause a zero point shift i.e. the measured value does not show zero when the vessel is empty or partially full.

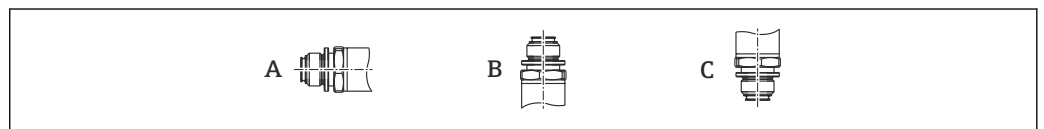

A0024708

Type	Process isolating diaphragm axis is horizontal (A)	Process isolating diaphragm pointing upwards (B)	Process isolating diaphragm pointing downwards (C)
PMP11 PMP21 PMP23	Calibration position, no effect	Up to +4 mbar (+0.058 psi)	Up to -4 mbar (-0.058 psi)
PMC11, PMC21 < 1 bar (15 psi)	Calibration position, no effect	Up to +0.3 mbar (+0.0044 psi)	Up to -0.3 mbar (-0.0044 psi)
PMC11, PMC21 ≥1 bar (15 psi)	Calibration position, no effect	Up to +3 mbar (+0.0435 psi)	Up to -3 mbar (-0.0435 psi)

## 5.4 Mounting location

### 5.4.1 Pressure measurement

#### Pressure measurement in gases

Mount the device with shutoff device above the tapping point so that any condensate can flow into the process.

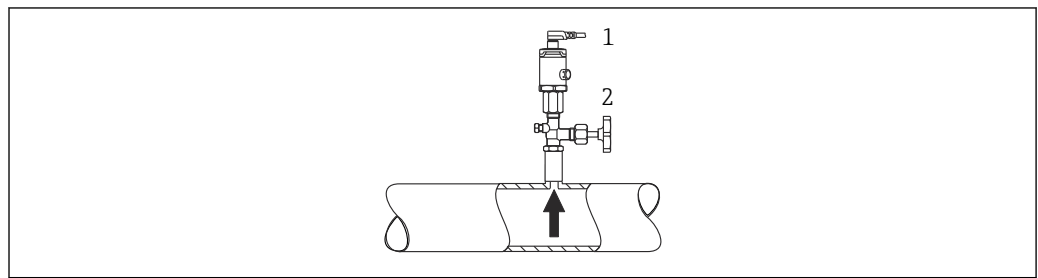

A0021904

- 1 Device
- 2 Shutoff device

#### Pressure measurement in vapors

For pressure measurement in vapors, use a siphon. The siphon reduces the temperature to almost ambient temperature. Mount the device with a shutoff device at the same height as the tapping point.

Advantage:

only minor/negligible heat effects on the device.

Note the max. permitted ambient temperature of the transmitter!

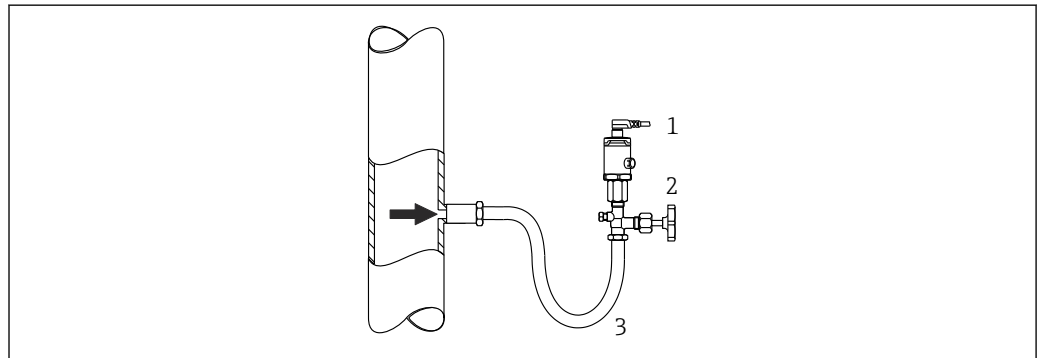

A0024395

- 1 Device
- 2 Shutoff device
- 3 Siphon



**Pressure measurement in liquids**

Mount the device with a shutoff device at the same height as the tapping point.

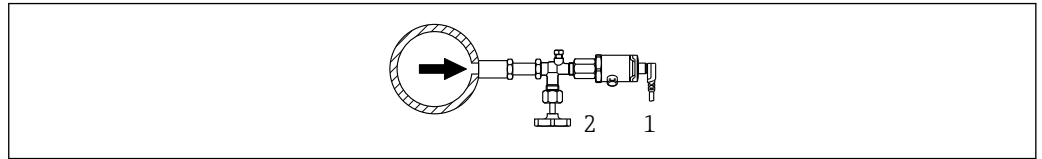

A0024399

- 1 Device
- 2 Shutoff device

**5.4.2 Level measurement**

- Always install the device below the lowest measuring point.
- Do not install the device at the following positions:
  - In the filling curtain
  - In the tank outlet
  - in the suction area of a pump
  - Or at a point in the tank which could be affected by pressure pulses from the agitator.

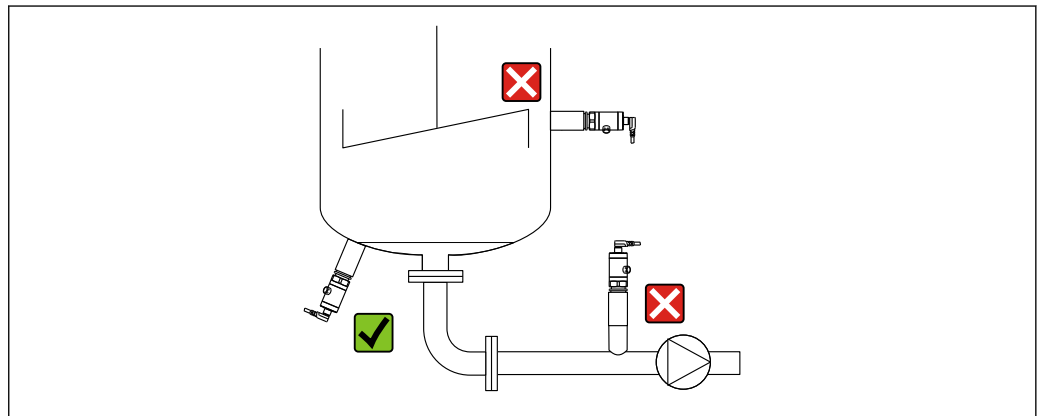

A0024405

**5.5 Mounting of the profile seal for universal process mounting adapter**

For details on mounting, see KA00096F/00/A3.

**5.6 Mounting instructions for oxygen applications**

Oxygen and other gases can react explosively to oils, grease and plastics, such that, among other things, the following precautions must be taken:

- All components of the system, such as measuring devices, must be cleaned in accordance with the BAM requirements.
- Dependent on the materials used, a certain maximum temperature and a maximum pressure for oxygen applications must not be exceeded.
- The following table lists devices (devices only, not accessories or enclosed accessories), which are suitable for gaseous oxygen applications.

Device	P <sub>max</sub> for oxygen applications	T <sub>max</sub> for oxygen applications	Option <sup>1)</sup>
PMC21	40 bar (600 psi)	-10 to +60 °C (+14 to +140 °F)	HB

1) Product Configurator, order code for "Service"

## 5.7 Post-installation check

<input type="checkbox"/>	Is the device undamaged (visual inspection)?
<input type="checkbox"/>	Does the device comply with the measuring point specifications? For example: <ul style="list-style-type: none"> <li>▪ Process temperature</li> <li>▪ Process pressure</li> <li>▪ Ambient temperature</li> <li>▪ Measuring range</li> </ul>
<input type="checkbox"/>	Are the measuring point identification and labeling correct (visual inspection)?
<input type="checkbox"/>	Is the device adequately protected against precipitation and direct sunlight?
<input type="checkbox"/>	Are the securing screws tightened securely?
<input type="checkbox"/>	Is the pressure compensation element pointing downwards at an angle or to the side?
<input type="checkbox"/>	To prevent the penetration of moisture: are the connecting cables/plugs pointing downwards?

## 6 Electrical connection

### 6.1 Connecting the measuring unit

#### 6.1.1 Terminal assignment

**⚠ WARNING**

**Risk of injury from the uncontrolled activation of processes!**

- ▶ Switch off the supply voltage before connecting the device.
- ▶ Make sure that downstream processes are not started unintentionally.

**⚠ WARNING**

**Supply voltage might be connected!**

Explosion Hazard!

- ▶ Make sure that no supply voltage is applied when connecting.
- ▶ Switch off the supply voltage before connecting the device.

**⚠ WARNING**

**Limitation of electrical safety due to incorrect connection!**

- ▶ In accordance with IEC/EN61010 a suitable circuit breaker must be provided for the device.
- ▶ **Non-hazardous area:** To meet device safety specifications according to the IEC/EN61010 standard, the installation must ensure that the maximum current is limited to 500 mA.
- ▶ **Hazardous area:** The maximum current is restricted to  $I_i = 100$  mA by the transmitter power supply unit when the device is used in an intrinsically safe circuit (Ex ia).
- ▶ The device must be operated with a 500 mA fine-wire fuse (slow-blow).
- ▶ When using the measuring device in hazardous areas, installation must also comply with the corresponding national standards and regulations and the Safety Instructions or Installation or Control Drawings.
- ▶ All explosion protection data are given in separate documentation which is available upon request. The Ex documentation is supplied as standard with all devices approved for use in explosion hazardous areas.
- ▶ Protective circuits against reverse polarity are integrated.

Connect the device in the following order:

1. Check that the supply voltage corresponds to the supply voltage indicated on the nameplate.
2. Connect the device in accordance with the following diagram.

Switch on the supply voltage.

For devices with a cable connection: do not close reference air hose (see (a) in the following drawings)! Protect reference air hose against penetration by water/condensate.

4 to 20 mA output

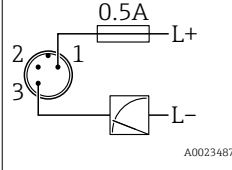
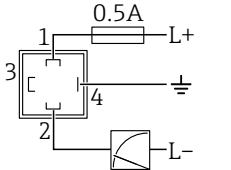
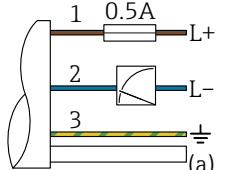
Device	M12 plug	Valve plug	Cable
PMC11 PMP11 PMC21 PMP21 PMP23	 A0023487	 A0022823	 A0023783  1 brown = L+ 2 blue = L- 3 green/yellow = ground connection (a) reference air hose

0 to 10 V output

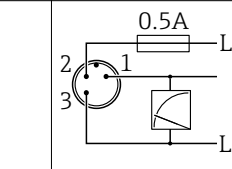
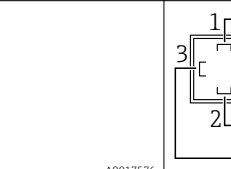
Device	M12 plug	Valve plug	Cable
PMC11 PMP11	 A0017576	 A0022822	-

6.1.2 Supply voltage



**Supply voltage might be connected!**

Risk of explosion!

- ▶ When using the measuring device in hazardous areas, installation must comply with the corresponding national standards and regulations as well as the Safety Instructions.
- ▶ All explosion protection data are given in separate documentation which is available upon request. The Ex documentation is supplied as standard with all devices approved for use in explosion hazardous areas.

Electronic version	Device	Supply voltage
4 to 20 mA output	PMC11 PMP11 PMC21 PMP21 PMP23	10 to 30 V DC
0 to 10 V output	PMC11 PMP11	12 to 30 V DC

6.1.3 Current consumption and alarm signal

Electronic version	Device	Current consumption	Alarm signal <sup>1)</sup>
4 to 20 mA output	PMC11 PMP11 PMC21 PMP21 PMP23	≤ 26 mA	> 21 mA
0 to 10 V output	PMC11 PMP11	< 12 mA	11 V

1) For MAX alarm (factory setting)

## 6.2 Switching capacity

- Switch cycles: >10,000,000
- Voltage drop PNP: ≤2 V
- Overload protection: Automatic load testing of switching current;
  - Max. capacitive load: 14 µF at max. supply voltage (without resistive load)
  - Max. cycle duration: 0.5 s; min.  $t_{on}$ : 4 ms
  - Periodic disconnection from protective circuit in the event of overcurrent ( $f = 2$  Hz) and "F804" displayed

## 6.3 Connection conditions

### 6.3.1 Cable specification

For valve plug: < 1.5 mm<sup>2</sup> (16 AWG) and Ø4.5 to 10 mm (0.18 to 0.39 in)

## 6.4 Connection data

### 6.4.1 Load (for 4 to 20 mA devices )

In order to guarantee sufficient terminal voltage in two-wire devices, a maximum load resistance  $R_L$  (including line resistance) must not be exceeded depending on the supply voltage  $U_B$  of the supply unit.

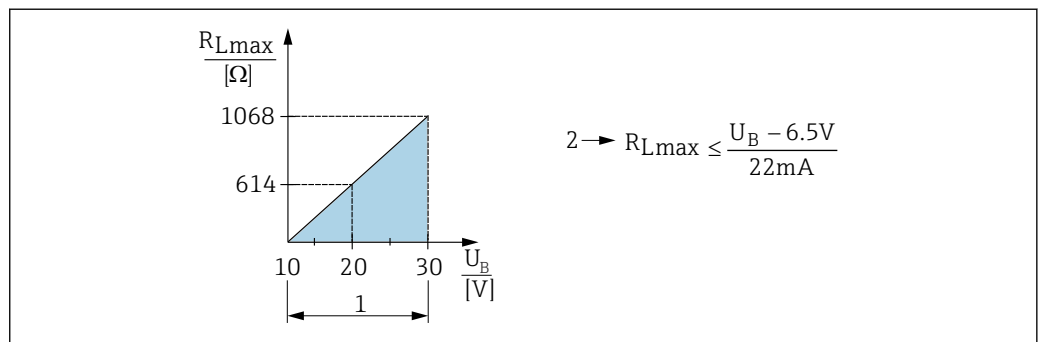

- 1 Power supply 10 to 30 V DC  
 2  $R_{Lmax}$  Maximum load resistance  
 $U_B$  Supply voltage

### 6.4.2 Load resistance (for 0 to 10 V devices)

The load resistance must be ≥ 5 [kΩ].

## 6.5 Post-connection check

<input type="checkbox"/>	Are the device or cables free from damage (visual check)?
<input type="checkbox"/>	Do the cables comply with the requirements?
<input type="checkbox"/>	Do the mounted cables have adequate strain relief?
<input type="checkbox"/>	Are all the cable glands installed, firmly tightened and leak-tight?
<input type="checkbox"/>	Does the supply voltage match the specifications on the nameplate?
<input type="checkbox"/>	Is the terminal assignment correct ?
<input type="checkbox"/>	If required: has protective ground connection been established?

## 7 Operation options

### 7.1 Plug-on display PHX20 (optional)

Devices with valve plug can be fitted with the optional local display PHX20.

A 1-line liquid crystal display (LCD) is used. The local display shows measured values, fault messages and information messages. The device display can be turned in 90° steps. Depending on the orientation of the device, it is therefore easy to read the measured values.

#### 7.1.1 Storage conditions

- Use original packaging.
- Storage temperature range: -30 to +80 °C (-22 to +176 °F)

#### 7.1.2 Installation

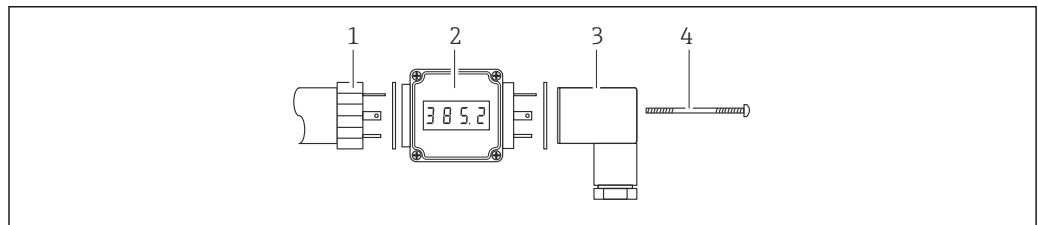

A0022208

1. Place seals between the sensor and plug-on display and between the plug-on display and plug.
2. Insert plug-on display (2) between plug (3) and plug socket (1) of sensor.
3. Replace securing screw (4) with the extended screw that is included in the scope of delivery.
4. An adhesive label specifying the technical unit, which is included in the scope of delivery, can be applied below the LED display.

#### Mounting dimensions

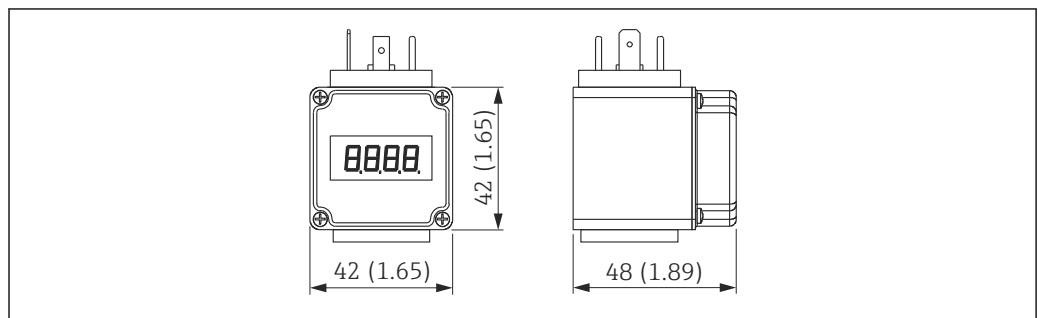

A0022210

#### 7.1.3 Technical data

Display:	4-digit, red LED display
Digit height:	7.62 mm; programmable decimal point setting
Display range:	-1999...9999
Accuracy:	0.2% of span ±1 digit

Electrical connection:	to transmitter with 4 to 20 mA output and elbow plug DIN 43 650, with reverse polarity protection
Power supply for display:	not required, self-powered by the current loop
Voltage drop:	$\leq 5$ V (corresponds to load: max. 250 $\Omega$ )
Conversion rate:	3 measurements per second
Damping:	0.3 to 20 s (configurable)
Data backup:	non-volatile EEPROM
Error message:	<ul style="list-style-type: none"> <li>▪ HI: Overranging</li> <li>▪ LO: Underranging</li> </ul>
Programming:	via 2 buttons, menu-guided, scaling of display range, decimal point, damping, error message
Degree of protection:	IP 65
Effect of temperature on display:	0.1% / 10 K
Electromagnetic compatibility (EMC):	Interference emission as per EN 50081, interference immunity as per EN 50082
Permitted current load:	max. 60 mA
Ambient temperature:	0 to +60 °C (+32 to +140 °F)
Housing material:	Plastic Pa6 GF30, blue Front screen made of PMMA, red
Order number:	52022914

#### 7.1.4 Electrical connection

##### Pin assignment

##### WARNING

##### Is the supply voltage switched off?

Risk of electric shock!

- ▶ Switch off the supply voltage before connecting the device.

- PIN 1: L+ (supply voltage  $U_B$ )
- PIN 2: L- (0 V)
- PIN 3: not used

##### Supply voltage

The supply voltage (usually 24 V DC) must be greater than the sum of the voltage drop  $U_s$  at the sensor, voltage drop 5 V at the display and other voltage losses  $U_a$  (such as additional analysis and line losses).

The following therefore applies:  $U_b = U_s + 5 \text{ V} + U_a$

##### Post-connection check

<input type="checkbox"/>	Is the device or cable undamaged (visual check)?
<input type="checkbox"/>	Are all cable glands installed, securely tightened and leak-tight?
<input type="checkbox"/>	If supply voltage is present, is the device ready for operation and do values appear on the display module?

#### 7.1.5 Commissioning

##### WARNING

##### Risk of injury from the uncontrolled activation of processes!

- ▶ Ensure that no uncontrolled processes are activated in the system.

### Configuring menu items

To configure, release the four Phillips screws (1) on the display and remove the cover.

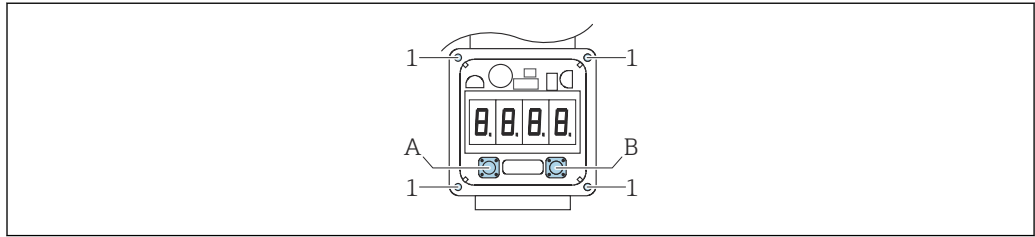

A0022209

- A Scroll downwards in menu and select menu items
- B Scroll upwards in menu and select menu items
- A+B Select menu item to make or confirm the setting

### Setting the decimal point

Press button B until "dP" is displayed.	d P
Press A+B to set decimal point:	- - . -
Press B or A to go up or down:	- . - -
Press A+B to quit the setting function and to go to the "dP" menu item.	d P

### Setting the range overshoot

Message, if signal below 4 mA or above 20 mA:

- "HI" message = range overshoot
- "LO" message = range undershoot

Press button B until "HILO" is displayed.	H I L O
Press A+B to set (message not active):	o F F
Press B or A to go up or down (message active):	o n
Press A+B to quit the setting function and to go to the "HILO" menu item.	H I L O

Please note: If "HILO" message is not active, error "Er06" is displayed if the display range is exceeded (-1999 to +9999).

### Switching to measuring mode

Depending on the menu item selected, press button A or B one to eight times.



## 8 Diagnostics and troubleshooting

### 8.1 Troubleshooting

If an inadmissible configuration exists in the device, the device switches to error mode.

#### General errors

Error	Possible cause	Solution
Device is not responding.	Supply voltage does not match that specified on the nameplate.	Apply correct voltage.
	Supply voltage has incorrect polarity.	Correct the polarity.
	Connecting cables are not in contact with the terminals.	Check the connection of the cables and correct if necessary.
Output current $\leq 3.6$ mA	Signal cable is not wired correctly.	Check wiring.

### 8.2 Response of output to errors

The response of the output to error is regulated in accordance with NAMUR NE43.

Factory setting MAX alarm:  $>21$  mA

#### 8.2.1 alarm current

Device	Description	Option
PMC21 PMP21 PMP23	Adjusted min. alarm current	IA <sup>1)</sup>

1) Product Configurator order code for "Service"

### 8.3 Disposal

When disposing, separate and recycle the device components based on the materials.

## 9 Maintenance

No special maintenance work is required.

Keep the pressure compensation element (1) free from contamination.

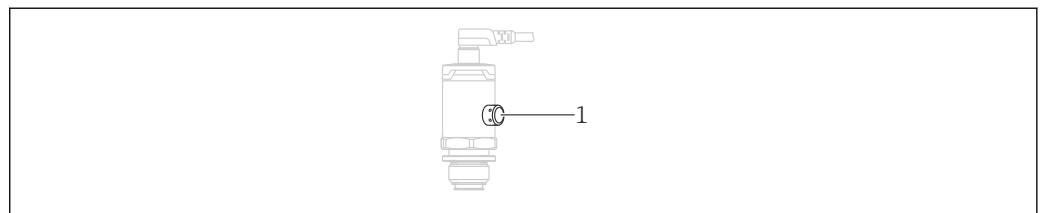

A0022141

## 9.1 Exterior cleaning

**Please note the following points when cleaning the device:**

- The cleaning agents used should not corrode the surface and the seals.
- Mechanical damage to the process isolating diaphragm, e.g. due to sharp objects, must be avoided.
- Observe the degree of protection of the device. See the nameplate if necessary →  13.

## 10 Repair

### 10.1 General information

#### 10.1.1 Repair concept

Repairs are not possible.

### 10.2 Return

The measuring device must be returned if the wrong device has been ordered or delivered.

As an ISO-certified company and also due to legal regulations, Endress+Hauser is obliged to follow certain procedures when handling any returned products that have been in contact with medium. To ensure swift, safe and professional device returns, please read the return procedures and conditions on the Endress+Hauser website at [www.services.endress.com/return-material](http://www.services.endress.com/return-material)

### 10.3 Disposal



If required by the Directive 2012/19/EU on waste electrical and electronic equipment (WEEE), the product is marked with the depicted symbol in order to minimize the disposal of WEEE as unsorted municipal waste. Do not dispose of products bearing this marking as unsorted municipal waste. Instead, return them to Endress+Hauser for disposal under the applicable conditions.

## 11 Accessories

### 11.1 Weld-in adapter

Various weld-in adapters are available for installation in vessels or pipes.

Device	Description	Option <sup>1)</sup>	Order number
PMP23	Weld-in adapter M24, d=65, 316L	PM	71041381
PMP23	Weld-in adapter M24, d=65, 316L 3.1 EN10204-3.1 material, inspection certificate	PN	71041383
PMP21	Weld-in adapter G½, 316L	QA	52002643
PMP21	Weld-in adapter G½, 316L 3.1 EN10204-3.1 material, inspection certificate	QB	52010172
PMP21	Weld-in tool adapter G½, brass	QC	52005082
PMP21	Weld-in adapter G1/2, 316L, for G1/2 A DIN 3852	QM	71389241
PMP21	Weld-in adapter G1/2, 316L, 3.1, for G1/2 A DIN 3852, EN10204-3.1 material, inspection certificate	QN	71389243
PMP23	Weld-in adapter G1, 316L, conical metal joint	QE	52005087
PMP23	Weld-in adapter G1, 316L, 3.1, conical metal joint, EN10204-3.1 material, inspection certificate	QF	52010171
PMP23	Weld-in tool adapter G1, brass	QG	52005272
PMP23	Weld-in adapter G1, 316L, silicone O-ring seal	QJ	52001051
PMP23	Weld-in adapter G1, 316L, 3.1, silicone O-ring seal, EN10204-3.1 material, inspection certificate	QK	52011896
PMP23	Weld-in adapter Uni D65, 316L	QL	214880-0002
PMP23	Weld-in adapter Uni D65, 316L 3.1 EN10204-3.1 material, inspection certificate	QM	52010174
PMP23	Weld-in tool adapter Uni D65/D85, brass	QN	71114210
PMP23	Weld-in adapter Uni D85, 316L	QP	52006262
PMP23	Weld-in adapter Uni D85, 316L 3.1 EN10204-3.1 material, inspection certificate	QR	52010173

1) Product Configurator, order code for "Enclosed accessories"

If installed horizontally and weld-in adapters with a leakage hole are used, ensure that the leakage hole is pointing down. This allows leaks to be detected as quickly as possible.

### 11.2 Process adapter M24

The following process adapters can be ordered for the process connections with order option X2J and X3J:

Device	Description	Order number	Order number with inspection certificate 3.1 EN10204
PMP23	Varivent F DN32 PN40	52023996	52024003
PMP23	Varivent N DN50 PN40	52023997	52024004
PMP23	DIN11851 DN40	52023999	52024006
PMP23	DIN11851 DN50	52023998	52024005
PMP23	SMS 1½"	52026997	52026999

Device	Description	Order number	Order number with inspection certificate 3.1 EN10204
PMP23	Clamp 1½"	52023994	52024001
PMP23	Clamp 2"	52023995	52024002

### 11.3 Plug-on display PHX20

→ 22

### 11.4 M12 plug connectors

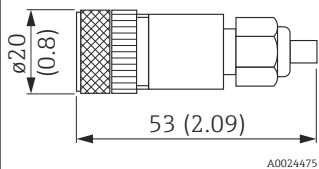
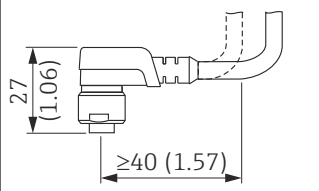
Connector	Degree of protection	Material	Option <sup>1)</sup>	Order number
M12 (self-terminated connection at M12 plug) 	IP67	<ul style="list-style-type: none"> <li>■ Union nut: Cu Sn/Ni</li> <li>■ Body: PBT</li> <li>■ Seal: NBR</li> </ul>	R1	52006263
M12 90 degrees with 5m (16 ft) cable 	IP67	<ul style="list-style-type: none"> <li>■ Union nut: GD Zn/Ni</li> <li>■ Body: PUR</li> <li>■ Cable: PVC</li> </ul> Cable colors <ul style="list-style-type: none"> <li>■ 1 = BN = brown</li> <li>■ 2 = WT = white</li> <li>■ 3 = BU = blue</li> <li>■ 4 = BK = black</li> </ul>	RZ	52010285

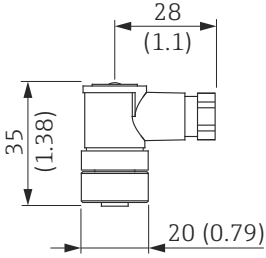
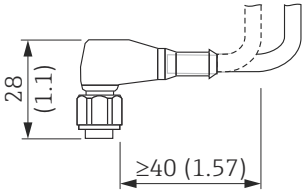
Connector	Degree of protection	Material	Option <sup>1)</sup>	Order number
<p>M12 90 degrees (self-terminated connection at M12 plug)</p>  <p style="text-align: right; font-size: small;">A0024478</p>	<p>IP67</p>	<ul style="list-style-type: none"> <li>▪ Union nut: GD Zn/Ni</li> <li>▪ Body: PBT</li> <li>▪ Seal: NBR</li> </ul>	<p>RM</p>	<p>71114212</p>
<p>M12 90 degrees with 5m (16 ft) cable (terminated at one end)</p>  <p style="text-align: right; font-size: small;">A0024477</p>	<p>IP69 <sup>2)</sup></p>	<ul style="list-style-type: none"> <li>▪ Union nut: 316L (1.4435)</li> <li>▪ Body and cable: PVC and PUR</li> </ul>	<p>RW</p>	<p>52024216</p>

- 1) Product Configurator, order code for "Enclosed accessories"
- 2) Designation of the IP protection class according to DIN EN 60529. Previous designation "IP69K" according to DIN 40050 Part 9 is no longer valid (standard withdrawn on November 1, 2012). The tests required by both standards are identical.

## 12 Technical data

### 12.1 Input

#### 12.1.1 Measured variable

##### Measured process variable

- PMC11: Gauge pressure
- PMP11: Gauge pressure
- PMC21: Gauge pressure or absolute pressure
- PMP21: Gauge pressure or absolute pressure
- PMP23: Gauge pressure or absolute pressure

##### Calculated process variable

Pressure

#### 12.1.2 Measuring range

##### Ceramic process isolating diaphragm

Sensor	Device	Maximum Sensor measuring range		Lowest calibratable span <sup>1)</sup>	MWP	OPL	Factory settings <sup>2)</sup>	Option <sup>3)</sup>
		lower (LRL)	upper (URL)					
		[bar (psi)]	[bar (psi)]					
<b>Devices for gauge pressure measurement</b>								
100 mbar (1.5 psi) <sup>4)</sup>	PMC21	-0.1 (-1.5)	+0.1 (+1.5)	0.02 (0.3)	2.7 (40.5)	4 (60)	0 to 100 mbar (0 to 1.5 psi)	1C
250 mbar (4 psi) <sup>5)</sup>	PMC21	-0.25 (-4)	+0.25 (+4)	0.05 (1)	3.3 (49.5)	5 (75)	0 to 250 mbar (0 to 4 psi)	1E
400 mbar (6 psi) <sup>6)</sup>	PMC11 PMC21	-0.4 (-6)	+0.4 (+6)	0.08 (1.2)	5.3 (79.5)	8 (120)	0 to 400 mbar (0 to 6 psi)	1F
1 bar (15 psi) <sup>6)</sup>	PMC11 PMC21	-1 (-15)	+1 (+15)	0.2 (3)	6.7 (100.5)	10 (150)	0 to 1 bar (0 to 15 psi)	1H
2 bar (30 psi) <sup>6)</sup>	PMC11 PMC21	-1 (-15)	+2 (+30)	0.4 (6)	12 (180)	18 (270)	0 to 2 bar (0 to 30 psi)	1K
4 bar (60 psi) <sup>6)</sup>	PMC11 PMC21	-1 (-15)	+4 (+60)	0.8 (12)	16.7 (250.5)	25 (375)	0 to 4 bar (0 to 60 psi)	1M
6 bar (90 psi) <sup>6)</sup>	PMC11 PMC21	-1 (-15)	+6 (+90)	2.4 (36)	26.7 (400.5)	40 (600)	0 to 6 bar (0 to 90 psi)	1N
10 bar (150 psi) <sup>6)</sup>	PMC11 PMC21	-1 (-15)	+10 (+150)	2 (30)	26.7 (400.5)	40 (600)	0 to 10 bar (0 to 150 psi)	1P
16 bar (240 psi) <sup>6)</sup>	PMC11 PMC21	-1 (-15)	+16 (+240)	6.4 (96)	40 (600)	60 (900)	0 to 16 bar (0 to 240 psi)	1Q
25 bar (375 psi) <sup>6)</sup>	PMC11 PMC21	-1 (-15)	+25 (+375)	10 (150)	40 (600)	60 (900)	0 to 25 bar (0 to 375 psi)	1R
40 bar (600 psi) <sup>6)</sup>	PMC11 PMC21	-1 (-15)	+40 (+600)	8 (120)	40 (600)	60 (900)	0 to 40 bar (0 to 600 psi)	1S

Sensor	Device	Maximum Sensor measuring range		Lowest calibratable span <sup>1)</sup>	MWP	OPL	Factory settings <sup>2)</sup>	Option <sup>3)</sup>
		lower (LRL)	upper (URL)					
		[bar (psi)]	[bar (psi)]					
<b>Devices for absolute pressure measurement</b>								
100 mbar (1.5 psi) <sup>6)</sup>	PMC21	0	+0.1 (+1.5)	0.1 (1.5)	2.7 (40.5)	4 (60)	0 to 100 mbar (0 to 1.5 psi)	2C
250 mbar (4 psi) <sup>6)</sup>	PMC21	0	+0.25 (+4)	0.25 (4)	3.3 (49.5)	5 (75)	0 to 250 mbar (0 to 4 psi)	2E
400 mbar (6 psi) <sup>6)</sup>	PMC21	0	+0.4 (+6)	0.4 (6)	5.3 (79.5)	8 (120)	0 to 400 mbar (0 to 6 psi)	2F
1 bar (15 psi) <sup>6)</sup>	PMC21	0	+1 (+15)	0.4 (6)	6.7 (100.5)	10 (150)	0 to 1 bar (0 to 15 psi)	2H
2 bar (30 psi) <sup>6)</sup>	PMC21	0	+2 (+30)	0.4 (6)	12 (180)	18 (270)	0 to 2 bar (0 to 30 psi)	2K
4 bar (60 psi) <sup>6)</sup>	PMC21	0	+4 (+60)	0.8 (12)	16.7 (250.5)	25 (375)	0 to 4 bar (0 to 60 psi)	2M
10 bar (150 psi) <sup>6)</sup>	PMC21	0	+10 (+150)	2 (30)	26.7 (400.5)	40 (600)	0 to 10 bar (0 to 150 psi)	2P
40 bar (600 psi) <sup>6)</sup>	PMC21	0	+40 (+600)	8 (120)	40 (600)	60 (900)	0 to 40 bar (0 to 600 psi)	2S

- 1) Highest turn down that can be set at the factory: 5:1. The turn down is preset and cannot be changed.
- 2) Other measuring ranges (e.g. -1 to +5 bar (-15 to 75 psi)) can be ordered with customer-specific settings (see the Product Configurator, order code for "Calibration; Unit" option "J"). It is possible to invert the output signal (LRV = 20 mA; URV = 4 mA). Prerequisite: URV < LRV
- 3) Product Configurator, order code for "Sensor range"
- 4) Vacuum resistance: 0.7 bar (10.5 psi) abs
- 5) Vacuum resistance: 0.5 bar (7.5 psi) abs
- 6) Vacuum resistance: 0 bar (0 psi) abs

*Maximum turn down which can be ordered for absolute pressure and gauge pressure sensors*

Devices for gauge pressure measurement

- 6 bar (90 psi), 16 bar (240 psi), 25 bar (375 psi): TD 1:1 to TD 2.5:1
- All other measuring ranges: TD 1:1 to TD 5:1

Devices for absolute pressure measurement

- 100 mbar (1.5 psi), 250 mbar (4 psi), 400 mbar (6 psi): TD 1:1
- 1 bar (15 psi): TD 1:1 to TD 2.5:1
- All other measuring ranges: TD 1:1 to TD 5:1



## Metal process isolating diaphragm

Sensor	Device	Maximum Sensor measuring range		Lowest calibratable span <sup>1)</sup>	MWP	OPL	Factory settings <sup>2)</sup>	Option <sup>3)</sup>
		lower (LRL)	upper (URL)					
		[bar (psi)]	[bar (psi)]					
<b>Devices for gauge pressure measurement</b>								
400 mbar (6 psi) <sup>4)</sup>	PMP11 PMP21 PMP23	-0.4 (-6)	+0.4 (+6)	0.4 (6)	1 (15)	1.6 (24)	0 to 400 mbar (0 to 6 psi)	1F
1 bar (15 psi) <sup>4)</sup>	PMP11 PMP21 PMP23	-1 (-15)	+1 (+15)	0.4 (6)	2.7 (40.5)	4 (60)	0 to 1 bar (0 to 15 psi)	1H
2 bar (30 psi) <sup>4)</sup>	PMP11 PMP21 PMP23	-1 (-15)	+2 (+30)	0.4 (6)	6.7 (100.5)	10 (150)	0 to 2 bar (0 to 30 psi)	1K
4 bar (60 psi) <sup>4)</sup>	PMP11 PMP21 PMP23	-1 (-15)	+4 (+60)	0.8 (12)	10.7 (160.5)	16 (240)	0 to 4 bar (0 to 60 psi)	1M
6 bar (90 psi) <sup>4)</sup>	PMP11 PMP21 PMP23	-1 (-15)	+6 (+90)	2.4 (36)	16 (240)	24 (360)	0 to 6 bar (0 to 90 psi)	1N
10 bar (150 psi) <sup>4)</sup>	PMP11 PMP21 PMP23	-1 (-15)	+10 (+150)	2 (30)	25 (375)	40 (600)	0 to 10 bar (0 to 150 psi)	1P
16 bar (240 psi) <sup>4)</sup>	PMP11 PMP21 PMP23	-1 (-15)	+16 (+240)	5 (75)	25 (375)	64 (960)	0 to 16 bar (0 to 240 psi)	1Q
25 bar (375 psi) <sup>4)</sup>	PMP11 PMP21 PMP23	-1 (-15)	+25 (+375)	5 (75)	25 (375)	100 (1500)	0 to 25 bar (0 to 375 psi)	1R
40 bar (600 psi) <sup>4)</sup>	PMP11 PMP21 PMP23	-1 (-15)	+40 (+600)	8 (120)	100 (1500)	160 (2400)	0 to 40 bar (0 to 600 psi)	1S
100 bar (1500 psi) <sup>4)</sup>	PMP21	-1 (-15)	+100 (+1500)	20 (300)	100 (1500)	160 (2400)	0 to 100 bar (0 to 1500 psi)	1U
400 bar (6000 psi) <sup>4)</sup>	PMP21	-1 (-15)	+400 (+6000)	80 (1200)	400 (6000)	600 (9000)	0 to 400 bar (0 to 6000 psi)	1W

Sensor	Device	Maximum Sensor measuring range		Lowest calibratable span <sup>1)</sup>	MWP	OPL	Factory settings <sup>2)</sup>	Option <sup>3)</sup>
		lower (LRL)	upper (URL)					
		[bar (psi)]	[bar (psi)]					
<b>Devices for absolute pressure measurement</b>								
400 mbar (6 psi) <sup>4)</sup>	PMP21 PMP23	0 (0)	0.4 (+6)	0.4 (6)	1 (15)	1.6 (24)	0 to 400 mbar (0 to 6 psi)	2F
1 bar (15 psi) <sup>4)</sup>	PMP21 PMP23	0 (0)	1 (+15)	0.4 (6)	2.7 (40.5)	4 (60)	0 to 1 bar (0 to 15 psi)	2H
2 bar (30 psi) <sup>4)</sup>	PMP21 PMP23	0 (0)	2 (+30)	0.4 (6)	6.7 (100.5)	10 (150)	0 to 2 bar (0 to 30 psi)	2K
4 bar (60 psi) <sup>4)</sup>	PMP21 PMP23	0 (0)	4 (+60)	0.8 (12)	10.7 (160.5)	16 (240)	0 to 4 bar (0 to 60 psi)	2M
10 bar (150 psi) <sup>4)</sup>	PMP21 PMP23	0 (0)	10 (+150)	2 (30)	25 (375)	40 (600)	0 to 10 bar (0 to 150 psi)	2P
40 bar (600 psi) <sup>4)</sup>	PMP21 PMP23	0 (0)	+40 (+600)	8 (120)	100 (1500)	160 (2400)	0 to 40 bar (0 to 600 psi)	2S
100 bar (1 500 psi) <sup>4)</sup>	PMP21	0 (0)	+100 (+1500)	20 (300)	100 (1500)	160 (2400)	0 to 100 bar (0 to 1 500 psi)	2U
400 bar (6 000 psi) <sup>4)</sup>	PMP21	0 (0)	+400 (+6000)	80 (1200)	400 (6000)	600 (9000)	0 to 400 bar (0 to 6 000 psi)	2W

- 1) Highest turn down that can be set at the factory: 5:1. The turn down is preset and cannot be changed.
- 2) Other measuring ranges (e.g. -1 to +5 bar (-15 to 75 psi)) can be ordered with customer-specific settings (see the Product Configurator, order code for "Calibration; Unit" option "J"). It is possible to invert the output signal (LRV = 20 mA; URV = 4 mA). Prerequisite: URV < LRV
- 3) Product Configurator, order code for "Sensor range"
- 4) Vacuum resistance: 0.01 bar (0.145 psi) abs

*Maximum turn down which can be ordered for absolute pressure and gauge pressure sensors*

Device	Range	400 mbar (6 psi)	1 bar (15 psi) 6 bar (90 psi) 16 bar (240 psi)	2 bar (30 psi) 4 bar (60 psi) 10 bar (150 psi) 25 to 400 bar (375 to 6000 psi) 25 to 40 bar (375 to 600 psi)
PMP11	0.5%	TD 1:1	TD 1:1 to TD 2.5:1	TD 1:1 to TD 5:1
PMP21	0.3%	TD 1:1	TD 1:1 to TD 2.5:1	TD 1:1 to TD 5:1
PMP23	0.3%	TD 1:1	TD 1:1 to TD 2.5:1	TD 1:1 to TD 5:1

## 12.2 Output

### 12.2.1 Output signal

Designation	Option <sup>1)</sup>
4 to 20 mA (2-wire)	1
PMC11: 0 to 10 V output (3-wire) PMP11: 0 to 10 V output (3-wire)	2

1) Product Configurator, order code for "Output"

### 12.2.2 Switching capacity

- Switch cycles: >10,000,000
- Voltage drop PNP: ≤2 V
- Overload protection: Automatic load testing of switching current;
  - Max. capacitive load: 14 µF at max. supply voltage (without resistive load)
  - Max. cycle duration: 0.5 s; min.  $t_{on}$ : 4 ms
  - Periodic disconnection from protective circuit in the event of overcurrent ( $f = 2$  Hz) and "F804" displayed

### 12.2.3 Signal range 4 to 20 mA

3.8 mA to 20.5 mA

### 12.2.4 Load (for 4 to 20 mA devices )

In order to guarantee sufficient terminal voltage in two-wire devices, a maximum load resistance  $R_L$  (including line resistance) must not be exceeded depending on the supply voltage  $U_B$  of the supply unit.

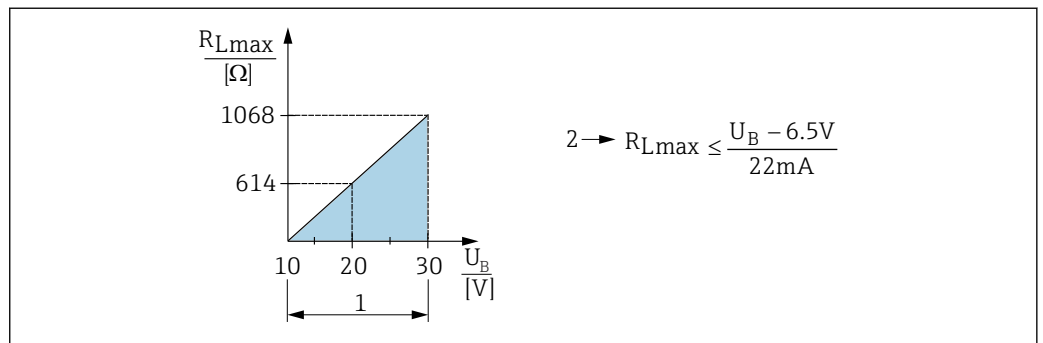

- 1 Power supply 10 to 30 V DC  
 2  $R_{Lmax}$  Maximum load resistance  
 $U_B$  Supply voltage

### 12.2.5 Load resistance (for 0 to 10 V devices)

The load resistance must be  $\geq 5$  [kΩ].

### 12.2.6 Signal on alarm 4 to 20 mA

The response of the output to error is regulated in accordance with NAMUR NE43.

Factory setting MAX alarm: >21 mA

**alarm current**

Device	Description	Option
PMC21 PMP21 PMP23	Adjusted min. alarm current	IA <sup>1)</sup>

1) Product Configurator order code for "Service"

**12.2.7 Dead time, time constant**

Presentation of the dead time and the time constant:

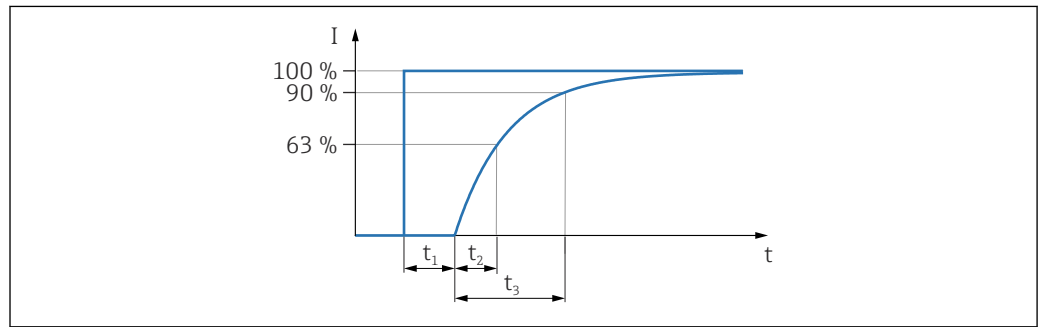

A0019786

**12.2.8 Dynamic behavior**

Dead time ( $t_1$ ) [ms]	Time constant ( $T_{63}$ ), $t_2$ [ms]	Time constant ( $T_{90}$ ), $t_3$ [ms]
6 ms	10 ms	15 ms

## 12.3 Performance characteristics of ceramic process isolating diaphragm

### 12.3.1 Reference operating conditions

- As per IEC 60770
- Ambient temperature  $T_A$  = constant, in the range of: +21 to +33 °C (+70 to +91 °F)
- Humidity  $\varphi$  = constant, in the range of 5 to 80 % rH
- Ambient pressure  $p_A$  = constant, in the range of: 860 to 1060 mbar (12.47 to 15.37 psi)
- Position of measuring cell = constant, in range: horizontal  $\pm 1^\circ$  (see also "Influence of the installation position" section →  15)
- Zero based span
- Material of process isolating diaphragm:  $Al_2O_3$  (aluminum-oxide ceramic, Ceraphire®)
- Supply voltage: 24 V DC  $\pm 3$  V DC
- Load: 320  $\Omega$  (at 4 to 20 mA output)

### 12.3.2 Measuring uncertainty for small absolute pressure measuring ranges

The smallest extended uncertainty of measurement that can delivered by our standards is:

- in range 1 to 30 mbar (0.0145 to 0.435 psi): 0.4 % of reading
- in range < 1 mbar (0.0145 psi): 1 % of reading.

### 12.3.3 Influence of the installation position

→  15

### 12.3.4 Resolution

Current output: min. 1.6  $\mu$ A

### 12.3.5 Reference accuracy

The reference accuracy contains the non-linearity [DIN EN 61298-2 3.11] including the pressure hysteresis [DIN EN 61298-23.13] and non-repeatability [DIN EN 61298-2 3.11] in accordance with the limit point method as per [DIN EN 60770].

Device	% of the calibrated span to the maximum turn down		
	Reference accuracy	Non-linearity <sup>1)</sup>	Non-repeatability
PMC11 <sup>2)</sup>	$\pm 0.5$	$\pm 0.1$	$\pm 0.1$
PMC21	$\pm 0.3$	$\pm 0.1$	$\pm 0.1$

- 1) The non-linearity for the 40 bar (600 psi) sensor can be up to  $\pm 0.15\%$  of the calibrated span up to the maximum turn down.
- 2) For devices with 0 to 10 V output, a non-linearity of up to max. 0.3 V can occur for signal values below 0.03 V.

Overview of the turn down ranges →  32

Measuring ranges	Turn down	Device	% of URL
100 mbar (1.5 psi) to 40 bar (600 psi)	1:1 to TD 5:1	PMC11	±0.5
		PMC21	±0.3 <sup>1)</sup>

- 1) For the 100 mbar (1.5 psi) and 250 mbar (4 psi) measuring ranges, the following applies: In the event of heat effects on the initial reference conditions, an additional deviation of max. 0.3 mbar (4.5 psi) from the zero point or the output span is possible.

### 12.3.6 Thermal change of the zero output and the output span

Measuring cell	-20 to +85 °C (-4 to +185 °F)	-40 to -20 °C (-40 to -4 °F) +85 to +100 °C (+185 to +212 °F)
	% of URL for TD 1:1	
<1 bar (15 psi)	<1	<1.2
≥ 1 bar (15 psi)	<0.8	<1

### 12.3.7 Long-term stability

1 year	5 years	8 years
% of URL		
±0.2	±0.4	±0.45

### 12.3.8 Switch-on time

≤2 s (For small measuring ranges, pay attention to the thermal compensation effects.)

## 12.4 Performance characteristics of metal process isolating diaphragm

### 12.4.1 Reference operating conditions

- As per IEC 60770
- Ambient temperature  $T_A$  = constant, in the range: +21 to +33 °C (+70 to +91 °F)
- Humidity  $\varphi$  = constant, in the range: 5 to 80 % rH
- Ambient pressure  $p_A$  = constant, in the range: 860 to 1060 mbar (12.47 to 15.37 psi)
- Position of measuring cell = constant, in the range: horizontal  $\pm 1^\circ$  (see also "Influence of the installation position" section →  15)
- Zero based span
- Process isolating diaphragm material: AISI 316L (1.4435)
- Filling oil: synthetic oil polyalphaolefin FDA 21 CFR 178.3620, NSF H1
- Supply voltage: 24 V DC  $\pm 3$  V DC
- Load: 320  $\Omega$  (at 4 to 20 mA output)

### 12.4.2 Measuring uncertainty for small absolute pressure measuring ranges

The smallest extended uncertainty of measurement that can be delivered by our standards is:

- in the range 1 to 30 mbar (0.0145 to 0.435 psi): 0.4 % of reading
- in the range < 1 mbar (0.0145 psi): 1 % of reading.

### 12.4.3 Influence of the installation position

→  15

### 12.4.4 Resolution

Current output: min. 1.6  $\mu$ A

### 12.4.5 Reference accuracy

The reference accuracy contains the non-linearity [DIN EN 61298-2 3.11] including the pressure hysteresis [DIN EN 61298-23.13] and non-repeatability [DIN EN 61298-2 3.11] in accordance with the limit point method as per [DIN EN 60770].

Device	% of the calibrated span to the maximum turn down		
	Reference accuracy	Non-linearity	Non-repeatability
PMP11 <sup>1)</sup>	$\pm 0.5$	$\pm 0.1$	$\pm 0.1$
PMP21	$\pm 0.3$	$\pm 0.1$	$\pm 0.1$
PMP23	$\pm 0.3$	$\pm 0.1$	$\pm 0.1$

1) For devices with 0 to 10 V output, a non-linearity of up to max. 0.3 V can occur for signal values below 0.015 V.

Overview of the turn down ranges →  34

### 12.4.6 Thermal change of the zero output and the output span

PMP11, PMP21

Measuring cell	-20 to +85 °C (-4 to +185 °F)	-40 to -20 °C (-40 to -4 °F) +85 to +100 °C (+185 to +212 °F)
	% of the calibrated span for TD 1:1	
<1 bar (15 psi)	<1	<1.2
≥1 bar (15 psi)	<0.8	<1

PMP23

Measuring cell	-20 to +85 °C (-4 to +185 °F)	-40 to -20 °C (-40 to -4 °F) +85 to +100 °C (+185 to +212 °F)
	% of the calibrated span for TD 1:1	
<1 bar (15 psi)	<1	<1.2
≥1 bar (15 psi)	<0.8	<1

### 12.4.7 Long-term stability

Device	1 year	5 years	8 years
	% of URL		
PMP11 PMP21 PMP23	±0.2	±0.4	±0.45

### 12.4.8 Switch-on time

≤2 s



## 12.5 Environment

### 12.5.1 Ambient temperature range

Device	Ambient temperature range <sup>1)</sup>
PMC11 PMP11	-40 to +70 °C (-40 to +158 °F)
PMC21 PMP21 PMP23	-40 to +85 °C (-40 to +185 °F)
PMC21 PMP21 PMP23	Devices for hazardous areas: -40 to +70 °C (-40 to +158 °F)

1) Exception: the following cable is designed for an ambient temperature range of -25 to +70 °C (-13 to +158 °F): Product Configurator order code for "Accessory enclosed" option "RZ".

### 12.5.2 Storage temperature range

-40 to +85 °C (-40 to +185 °F)

### 12.5.3 Climate class

Device	Climate class	Note
PMP23	Class 4K4H	Air temperature: -20 to +55 °C (-4 to +131 °F), relative humidity: 4 to 100 % satisfied according to DIN EN 60721-3-4 (condensation is possible)
PMC11 PMP11 PMC21 PMP21	Class 3K5	Air temperature: -5 to +45 °C (+23 to +113 °F), relative humidity: 4 to 95 % satisfied according to IEC 721-3-3 (condensation not possible)

### 12.5.4 Degree of protection

Device	Connection	Degree of protection	Option <sup>1)</sup>
PMC21 PMP21 PMP23	Cable 5 m (16 ft)	IP66/68 <sup>2)</sup> NEMA type 4X/6P enclosure	A
PMC21 PMP21 PMP23	Cable 10 m (33 ft)	IP66/68 <sup>2)</sup> NEMA type 4X/6P enclosure	B
PMC21 PMP21 PMP23	Cable 25 m (82 ft)	IP66/68 <sup>2)</sup> NEMA type 4X/6P enclosure	C
PMC11 PMP11	M12 plug	IP65 NEMA type 4X enclosure	L
PMC21 PMP21 PMP23	M12 plug	IP65/67 NEMA type 4X enclosure	M
PMP23	M12 plug made of metal	IP66/69 <sup>3)</sup> NEMA type 4X enclosure	N

Device	Connection	Degree of protection	Option <sup>1)</sup>
PMC11 PMP11 PMC21 PMP21 PMP23	Valve plug ISO4400 M16	IP65 NEMA type 4X enclosure	U
PMC11 PMP11 PMC21 PMP21 PMP23	Valve plug ISO4400 NPT ½	IP65 NEMA type 4X enclosure	V

- 1) Product Configurator, order code for "Electrical connection"
- 2) IP 68 (1.83m H2O for 24 h)
- 3) Designation of the IP protection class according to DIN EN 60529. Previous designation "IP69K" according to DIN 40050 Part 9 is no longer valid (standard withdrawn on November 1, 2012). The tests required by both standards are identical.

### 12.5.5 Vibration resistance

Test standard	Vibration resistance
IEC 60068-2-64:2008	Guaranteed for 5 to 2000Hz: 0.05g <sup>2</sup> /Hz

### 12.5.6 Electromagnetic compatibility

- Interference emission as per EN 61326-1 equipment B
- Interference immunity as per EN 61326-1 (industrial environment)
- Maximum deviation: 1.5% with TD 1:1

For more details please refer to the Declaration of Conformity.

## 12.6 Process

### 12.6.1 Process temperature range for devices with ceramic process isolating diaphragm

Device	Process temperature range
PMC11	-25 to +85 °C (-13 to +185 °F)
PMC21	-25 to +100 °C (-13 to +212 °F)
PMC21 for oxygen applications	-10 to +60 °C (+14 to +140 °F)

- For saturated steam applications, use a device with a metal process isolating diaphragm, or provide a siphon for temperature isolation when installing.
- Pay attention to the process temperature range of the seal. See also the following table.

Seal	Notes	Process temperature range	Option
FKM	-	-20 to +100 °C (-4 to +212 °F)	A <sup>1)</sup>
FKM	Cleaned for oxygen service	-10 to +60 °C (+14 to +140 °F)	A <sup>1)</sup> and HB <sup>2)</sup>
EPDM 70	-	-25 to +100 °C (-13 to +212 °F)	J <sup>1)</sup>

1) Product Configurator, order code for "Seal"

2) Product Configurator, order code for "Service"

#### Applications with changes in temperature

Frequent extreme changes in temperatures can temporarily cause measuring errors. Temperature compensation takes place after a few minutes. Internal temperature compensation is faster the smaller the change in temperature and the longer the time interval.

For further information please contact your local Endress+Hauser Sales Center.

### 12.6.2 Process temperature range for devices with metallic process isolating diaphragm

Device	Process temperature range
PMP11	-25 to +85 °C (-13 to +185 °F)
PMP21	-40 to +100 °C (-40 to +212 °F)
PMP23	-10 to +100 °C (+14 to +212 °F)
PMP23 Sterilization in place (SIP)	At +135°C (+275 °F) for a maximum of one hour (device in operation but not within measuring specification)

#### Applications with changes in temperature

Frequent extreme changes in temperatures can temporarily cause measuring errors. Internal temperature compensation is faster the smaller the change in temperature and the longer the time interval.

For further information please contact your local Endress+Hauser Sales Center.

### 12.6.3 Pressure specifications

#### **⚠ WARNING**

**The maximum pressure for the measuring device depends on the lowest-rated element with regard to pressure.**

- ▶ For pressure specifications, see the "Measuring range" section and "Mechanical construction" section in the Technical Information.
- ▶ The Pressure Equipment Directive (2014/68/EU) uses the abbreviation "PS". The abbreviation "PS" corresponds to the MWP (maximum working pressure) of the measuring device.
- ▶ MWP (maximum working pressure): The MWP (maximum working pressure) is specified on the nameplate. This value is based on a reference temperature of +20 °C (+68 °F) and may be applied to the device for an unlimited period of time. Observe the temperature dependency of the MWP.
- ▶ OPL (over pressure limit): The test pressure corresponds to the over pressure limit of the sensor and may only be applied temporarily to ensure that the measurement is within the specifications and no permanent damage develops. In the case of sensor range and process connections where the over pressure limit (OPL) of the process connection is smaller than the nominal value of the sensor, the device is set at the factory, at the very maximum, to the OPL value of the process connection. If you want to use the entire sensor range, select a process connection with a higher OPL value.
- ▶ Oxygen applications: In oxygen applications, the values for  $p_{\max}$  and  $T_{\max}$  for oxygen applications may not be exceeded .
- ▶ Devices with ceramic process isolating diaphragm: avoid steam hammering! Steam hammering can cause zero point drifts. Recommendation: Residue (water droplets or condensation) may remain on the process isolating diaphragm following CIP cleaning and can result in local steam hammering the next time steam cleaning takes place. In practice, drying the process isolating diaphragm (e.g. by blowing) has proved to prevent steam hammering.

## Index

### A

Application . . . . . 8

### C

CE mark (declaration of conformity) . . . . . 9

Cleaning . . . . . 26

### D

Declaration of Conformity . . . . . 9

Designated use . . . . . 8

Disposal . . . . . 25, 27

### E

Exterior cleaning . . . . . 26

### F

Field of application

Residual risks . . . . . 8

### M

Maintenance . . . . . 25

Media . . . . . 8

### N

Nameplate . . . . . 13

### O

Operational safety . . . . . 9

### P

Product safety . . . . . 9

### R

Repair concept . . . . . 27

### S

Safety instructions

Basic . . . . . 8

Safety Instructions (XA) . . . . . 5

Staff

Requirements . . . . . 8

### T

Troubleshooting . . . . . 25

### U

Using measuring device

Borderline cases . . . . . 8

Incorrect use . . . . . 8

see Designated use

### W

Workplace safety . . . . . 9







[www.addresses.endress.com](http://www.addresses.endress.com)

---