

Multi-stage performance filter

- current ratings from 1 to 36A
 - very high differential and common mode attenuation
 - good high-frequency attenuation
 - optional medical versions (B types)
-
- Nennströme von 1 bis 36A
 - Sehr hohe Gleich- und Gegentaktämpfung
 - Gute Hochfrequenzdämpfung
 - Optionale medizinische Versionen (Typ B)
-
- courants de service de 1 à 36A
 - très bonne atténuation en modes différentiel et mode commun
 - bonne atténuation à des hautes fréquences
 - en option version pour appareils médicaux (type B)



Filter selection table

Choose the filter FN xxxx-x with the required current rating and features, and add /?? to determine input/output (line/load) connection style. Example: FN 2070-10/06 is a 10A filter with fast-on connections.

Approvals



Filter	Connections			Current ratings at 40°C (25°) A	Inductance L mH	Capacitance		Resistance R MΩ	Housing	Weight g
	/06	/07	/08			Cx μF	Cy nF			
FN 2070-1 /??	/06	/07	-	1 (1.15)	22	0.33	4.7	1	K1	190
FN 2070-3 /??	/06	/07	-	3 (3.45)	9.8	0.47	4.7	0.47	K2	250
FN 2070-6 /??	/06	/07	-	6 (6.9)	7.8	1	4.7	0.22	P	450
FN 2070-10 /??	/06	/07	-	10 (11.5)	4.5	1	4.7	0.22	Q	730
FN 2070-12 /??	/06	/07	-	12 (13.8)	3.25	1	4.7	0.22	Q	730
FN 2070-16 /??	/06	/07	/08	16 (18.4)	2.8	1	4.7	0.22	L2	1000
FN 2070-25 /??	-	-	/08	25 (28.75)	2	2.2	4.7	0.22	Q	760
FN 2070-36 /??	-	-	/08	36 (41.4)	1.23	2.2	4.7	0.22	Q	790

Additional specifications

Filter type	Maximum operating voltage		Operating frequency Hz	Hipot test voltage		MTBF Per Mil-HB-217F at 40°C 230V hours	Maximum leakage mA/phase
	VAC	Hz		PN→E VAC	P→N VDC		
Standard types	250	50/60	DC to 400	2000	1700	400 000	0.4
B medical types (no Y capacitors)	250	50/60	DC to 400	2500	1700	400 000	0.002
A safety types (lower capacitance)	250	50/60	DC to 400	2500	1700	400 000	0.040

Electrical schematic

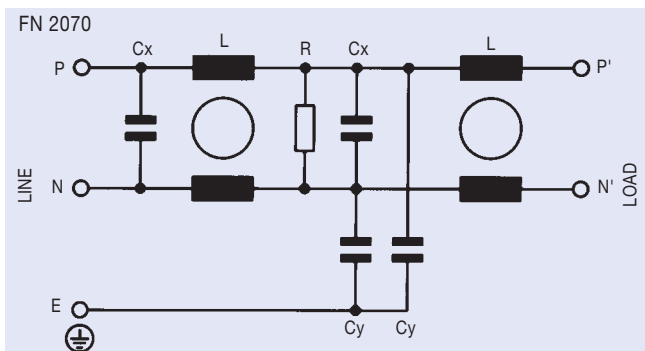

See tables for component values.

FN 2070 insertion loss

Per CISPR 17; A = 50Ω/50Ω sym, B = 50Ω/50Ω asym, C = 0.1Ω/100Ω sym, D = 100Ω/0.1Ω sym

1A types

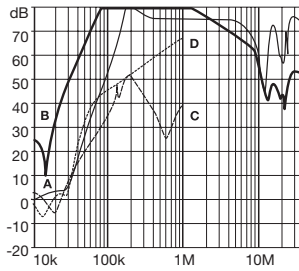

3A types

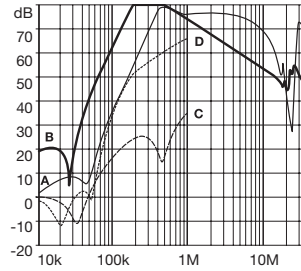

6A types

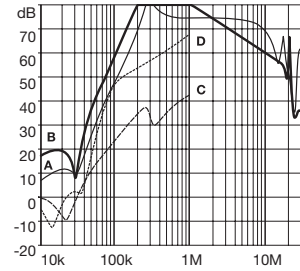

10A types (12A*)

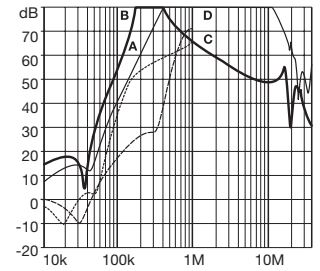

16A types

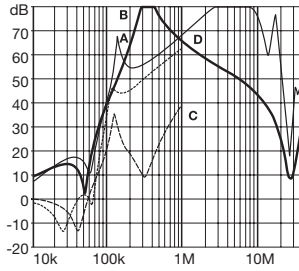

25A types

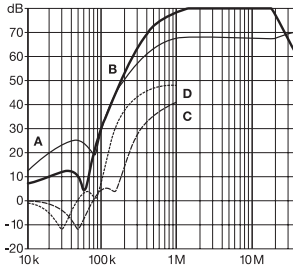

36A types

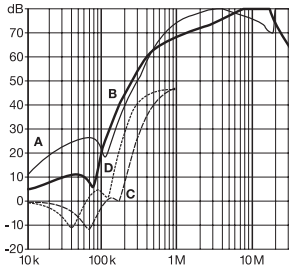

* attenuation performance of the 12A version is similar to the 10A component.

Mechanical data

Housing style	K1	K2	Toi. ± mm
A		85	± 0.5
B		54	± 0.5
C	30.3	40.3	± 0.5
D		64.8	± 0.5
F		75	± 0.3
J		27	± 0.2
K		12.3/8.3 [§]	± 0.5
L	20.8/23.3	29.8	± 0.5
M		5.3	± 0.1
N		6.3	± 0.1
P		0.7	± 0.1
S	19.9/34.9 [§]	11.4/34.9 [§]	± 0.5

§ with /07 connections
wire length of /07: 140 +5 mm

Housing style	P	Q	L2	Toi.* ± mm
A	113.5	156	119 ± 0.5	± 1
B		57.5	85.5	± 1
C		45.4 ± 1.2	57.6	± 1
D	94	130.5	98.5	± 1
F	103	143	109	± 0.3
J		25	40	± 0.2
K		12.4/8.4 [§]	15.6/8.6 [§]	± 0.5
L		32.4		± 0.5
M	4.4	5.3	4.4	± 0.1
N		6	7.4	± 0.1
P		0.9	1.2	± 0.1
Q			66	± 0.3
R			51	± 0.2
S		15.5/38 [§]		± 0.5

§ with /07 connections
wire length of /07: 140 +5 mm

* Measurements share this common tolerance unless otherwise stated.

All dimensions in mm; 1 inch = 25.4 mm

FRONT

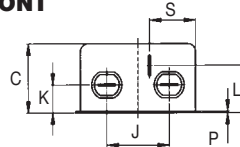

TOP

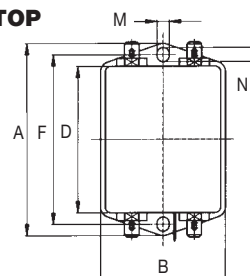

Housings K1, K2

FRONT

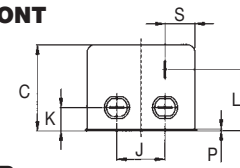

TOP

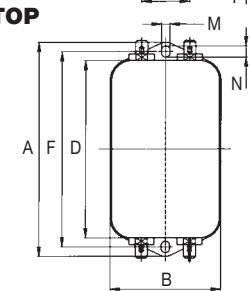

Housings P, Q

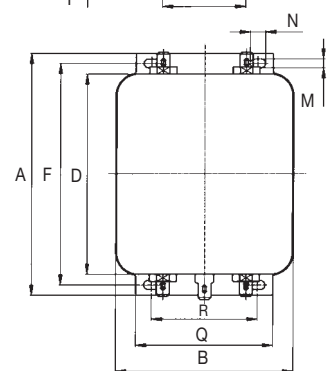
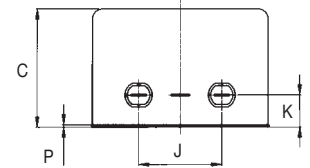

Housing L2