

E43227

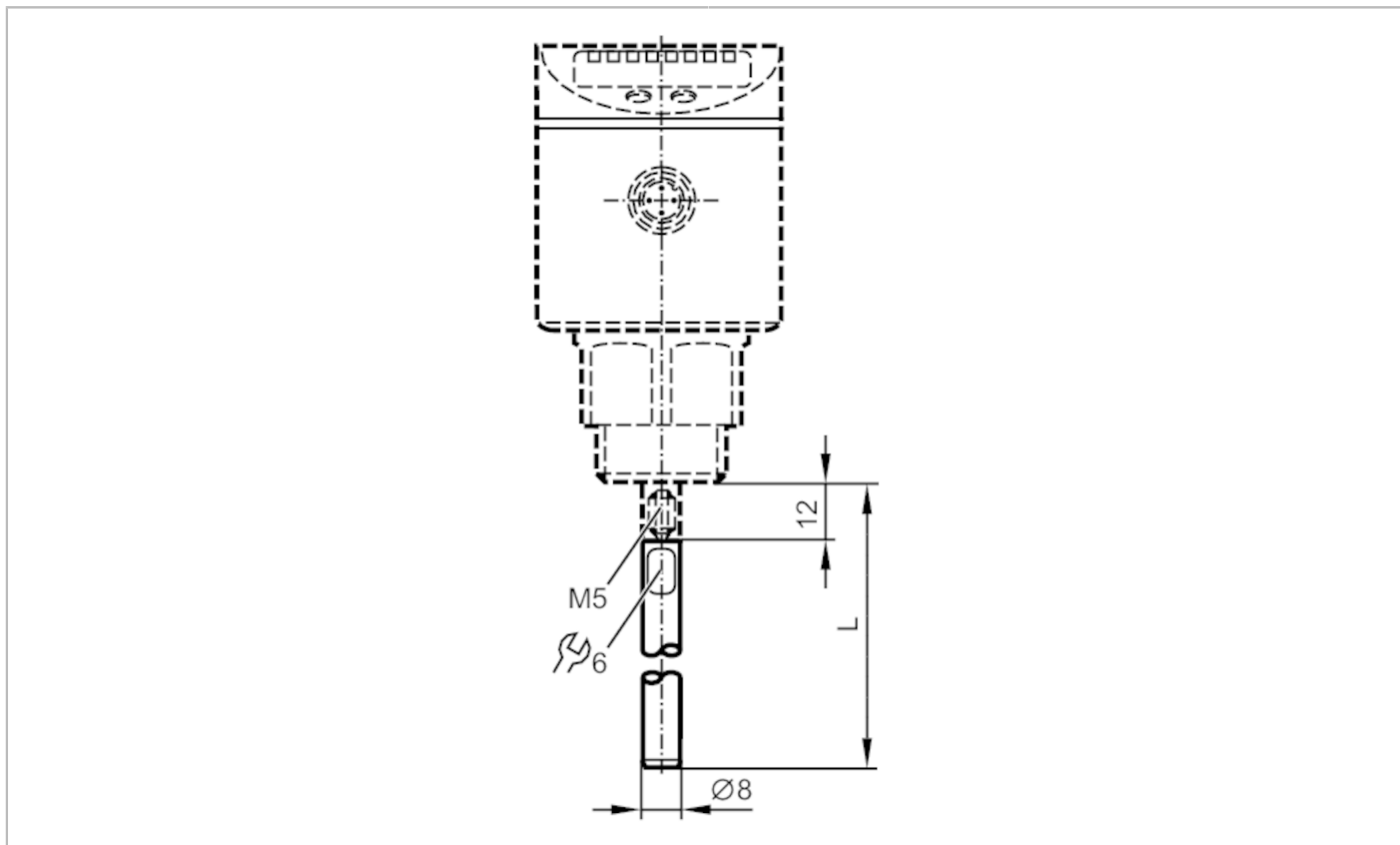

Probe for level sensors

LR PROBE L500



Application	
Design	for level sensors LR
Measuring/setting range	
Probe length L [mm]	500
Mechanical data	
Weight [g]	215.5
Materials	stainless steel (1.4404 / 316L)
Tightening torque [Nm]	4
Remarks	
Pack quantity	1 pcs.