

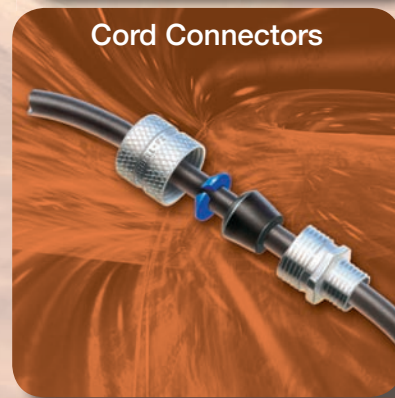

Section T Kellems® Wire Management Products

Index Product	Page
Kellems® Wire Mesh Grips Diagram	T-2
Quick Reference Selection Guide for Grip Applications	T-4
Pulling Grips	T-5
Overhead DUA-PULL® Pulling Grips	T-6
Overhead Multiple Strength Pulling Grips	T-7
Underground K-Type Pulling Grips	T-8
Underground T-Type Pulling Grips	T-9
Special Purpose Pulling Grips	T-10
Low Tension Pulling Grips	T-12
Wire Rope Splicing Grips	T-13
Cable Splicing Grips	T-14
Tools and Bands	T-15
Swivels	T-16
Technical Information	T-17
Support Grips	T-28
Standard Duty Support Grips	T-30
Heavy Support Grips	T-34
Service Drop Grips	T-36
Bus Drop Support Grips	T-38
Conduit Riser Grips	T-39
Support Grips Technical Information	T-42
Conduit Riser Grips Technical Information	T-47
Fiber Optic Cable Grips	T-49
Pulling Grips	T-50
Support Grips	T-53
Technical Information	T-54
Hose Containment Grips	T-58
Strain Relief Grips for Flexible Cords	T-59
Deluxe Cord Grips	T-60
PG and Metric Threaded Deluxe Cord Grips	T-64
Dust-Tight Strain Relief Grips	T-65
I-Grips	T-66
Adapters for Multi-Pin Connectors	T-67
Strain Relief Grips for Liquidtight Conduit	T-68
Technical Information	T-71
Cord Connectors	T-81
Straight Male Cord Connectors	T-82
45° Male Cord Connectors	T-85
90° Male Cord Connectors	T-86
Straight Female and Underground Feeder	T-87
Low Profile N.P.T., PG and Metric Thread Connectors	T-88
Accessories	T-89
Hubbell Juniors® Miniature Nylon Cord Connectors	T-90
Cord Connectors Technical Information	T-92
Hubbell Juniors® Technical Information	T-102
PolyTuff® Non-Metallic Liquidtight Conduit and Tubing	T-104
PolyTuff® Non-Metallic Liquidtight Fittings	T-106
Metallic Liquidtight Conduit Fittings	T-108
Technical Information	T-110





Wire Management Products Kellems® Wire Mesh Grips Diagram

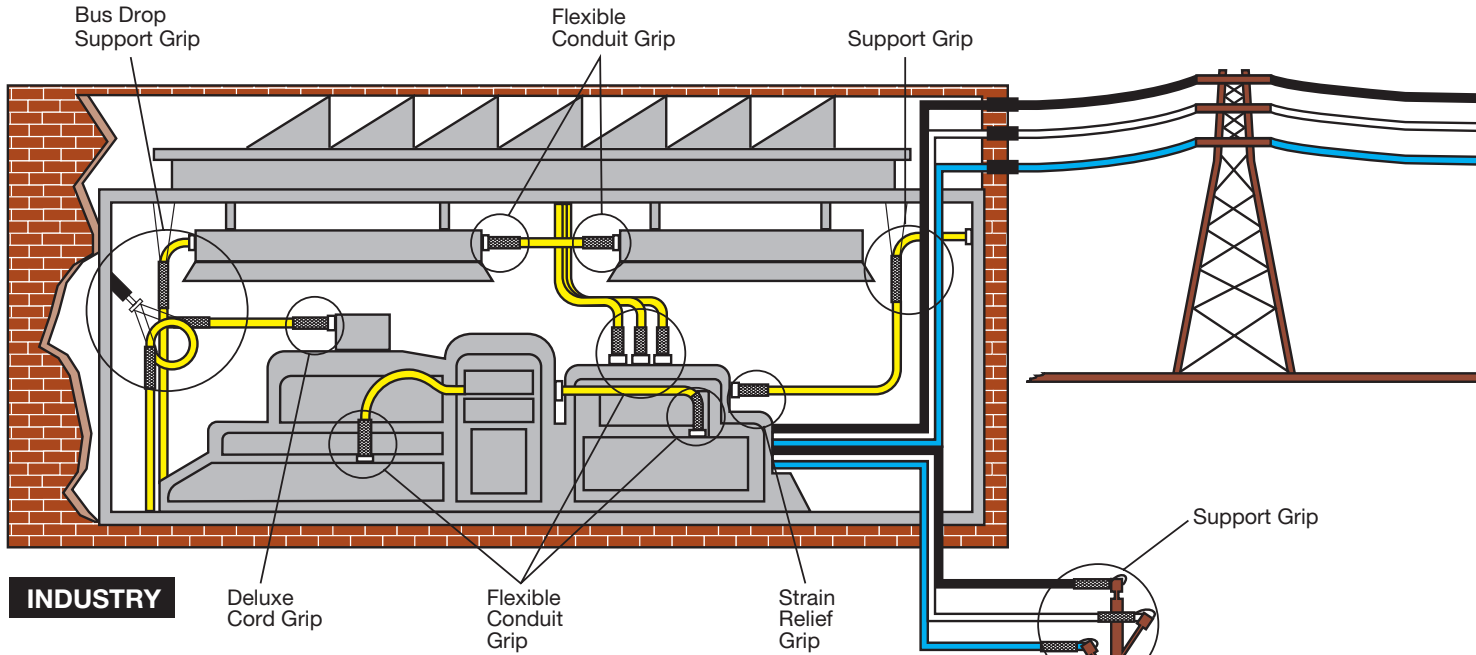

INDUSTRY

To help you fully visualize the variety of uses available to you through Hubbell-Kellems Mesh Grips, we have prepared this diagram of common applications. It follows the typical pattern of usage you would find traveling from utility to industrial, commercial and residential environments.

Pulling Grips are instrumental in the installations of transmission lines, service lines and cabling for construction and maintenance.

Support Grips provide holding management for indoor and outdoor permanent cable installations.

Strain Relief Grips are most often used to provide maximum reliability and minimum maintenance in areas where cords on machinery or equipment is impacted by motion or vibration or at risk of damage from cable pullout.

Beyond the electrical applications illustrated here, Hubbell-Kellems Mesh Grips can be used for wire management on radio and microwave communications towers, crane and hoist wire rope maintenance, elevator cable management and more.

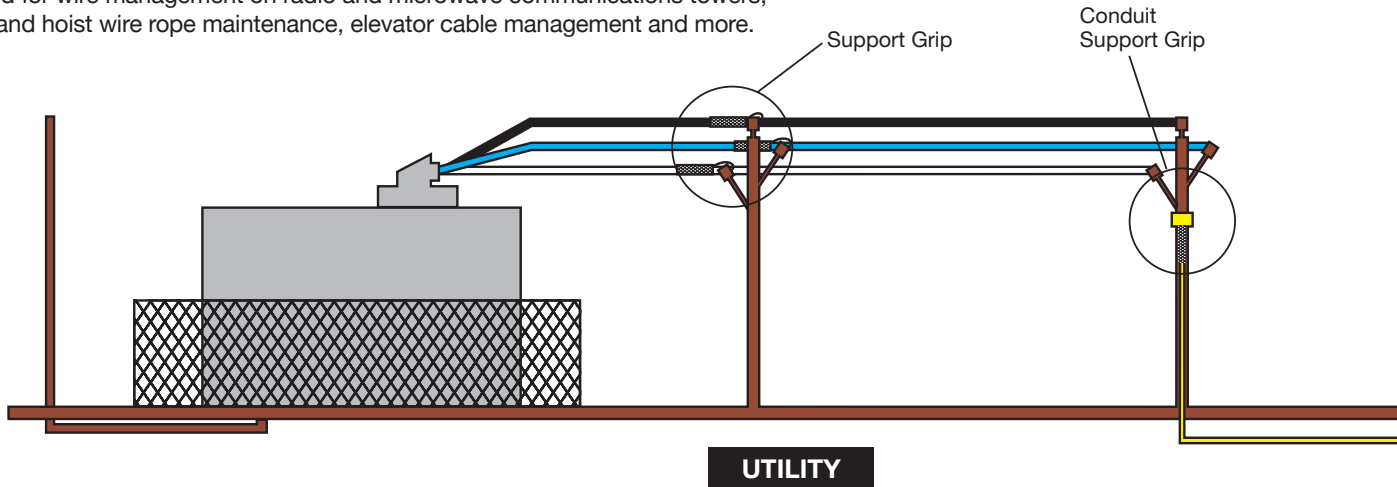
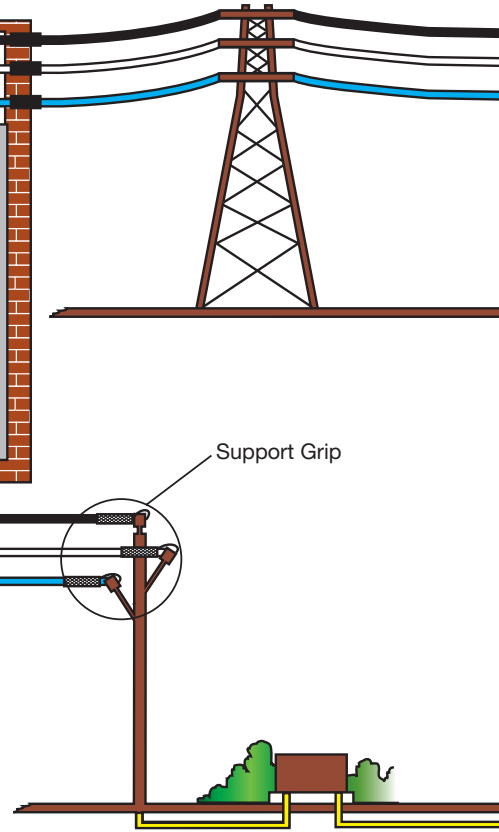

UTILITY

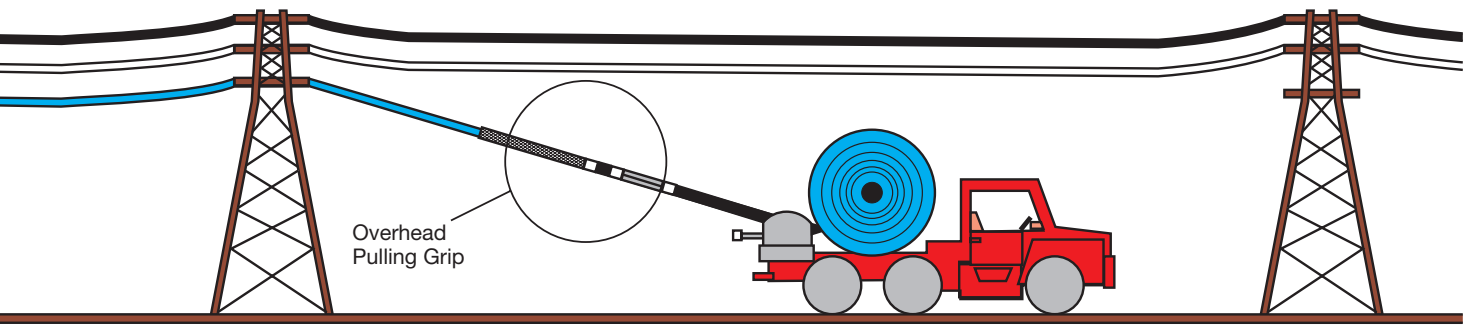

UTILITY

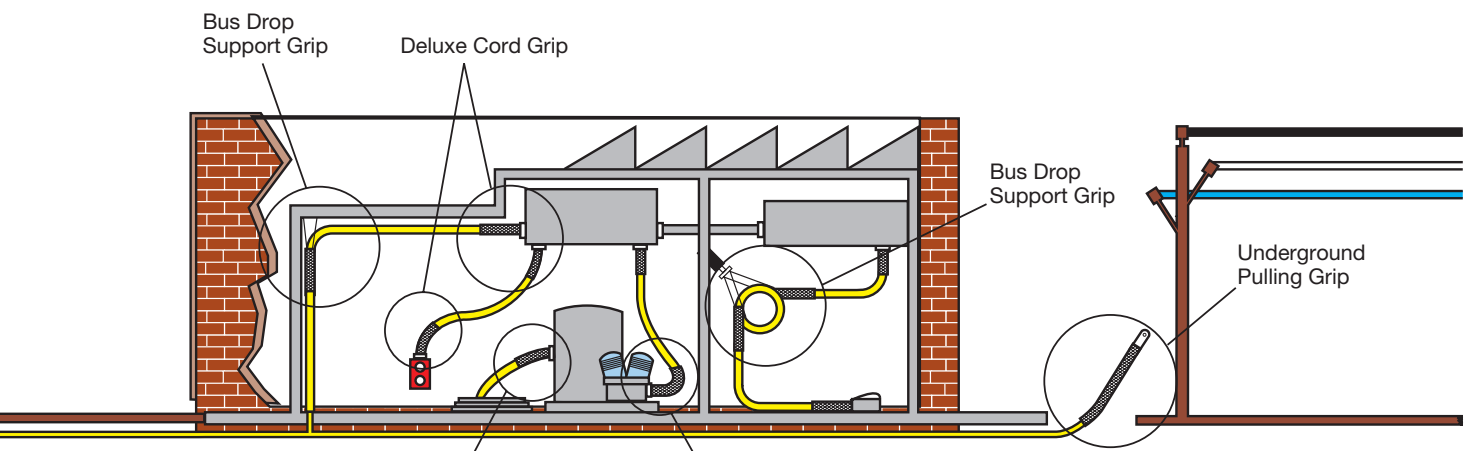

INDUSTRY

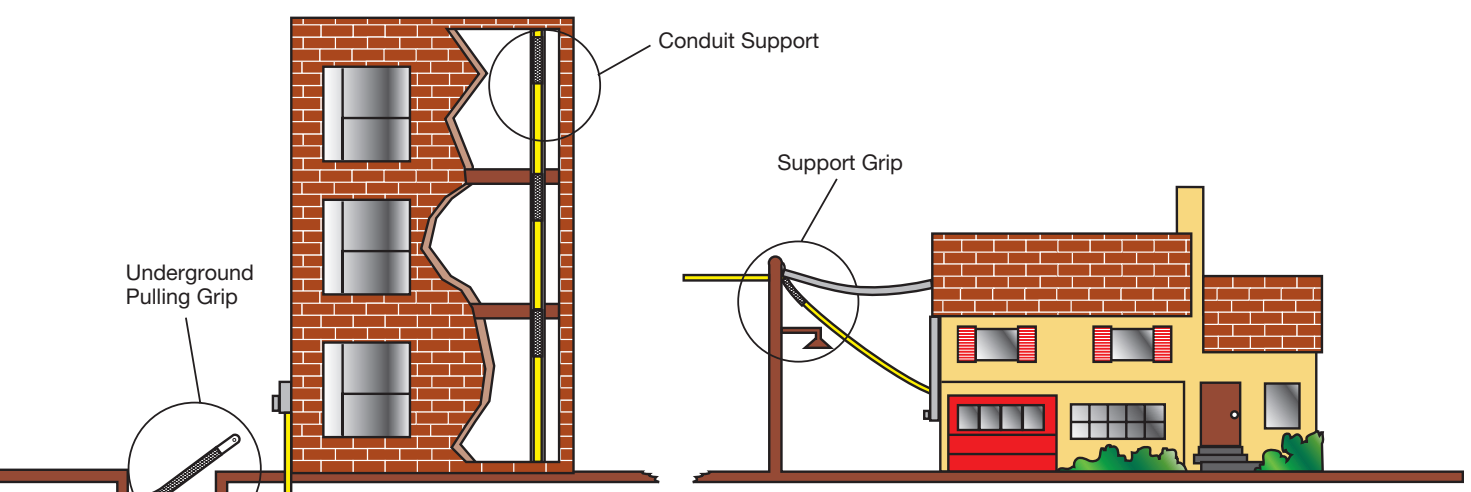

COMMERCIAL

RESIDENTIAL





Kellems® Wire Management Products

Quick Reference Selection Guide for Grip Applications

Pulling Grips

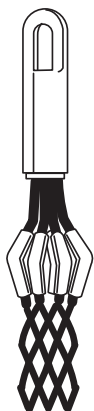

Heavy-Duty Rotating Eye
For underground wiring and overhead heavy-duty pulling of service lines and new construction cable. See pages T-7 and T-8.

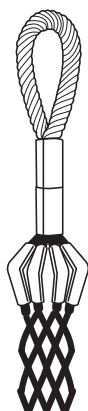

Heavy-Duty Flexible Eye
For overhead transmission and distribution line stringing. See pages T-6, T-7, and T-9.



Slack Grips
For removing underground cable and pulling slack in existing cable and new installations and when end of cable is not available. See pages T-10 and T-11.



Light-Duty Flexible Eye
For light industrial pulling of electrical cable and for underground and industrial plant wiring and re-wiring. See page T-12.

Support Grips



Single Eye
For single hook attachment of permanent indoor/outdoor cable. Available on heavy-duty, standard duty, and service drop grips. See pages T-30, T-34, and T-36.

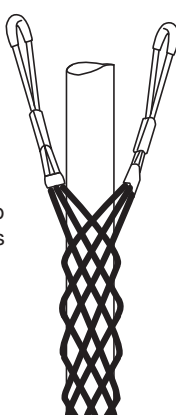

Double Eye
For double hook attachment of permanent indoor/outdoor cable. Available on heavy-duty and standard duty grips. See pages T-31 and T-35.

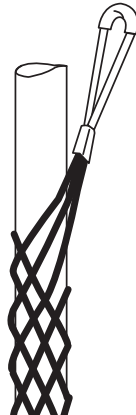

Single Offset Eye
For offset hook attachment of permanent indoor/outdoor cable. Available on standard duty and light-duty support grips. See page T-32.

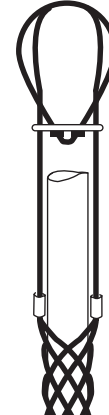

Universal Eye
Used to fasten around a structure or closed loop. Available on standard duty support and light or heavy duty service drop grips. See pages T-33 and T-37.

Support Grips

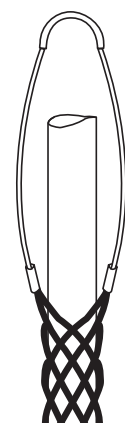

Wide Range Bus Drop
Used indoors for cable support where flexible cable connects electrical equipment to bus duct. Support air hose and water hose. See page T-38.



Dust-Tight Strain Relief
Indoor use only for wiring of electrical enclosures, machine tools, portable power tools, bus drop cable systems. See page T-65.

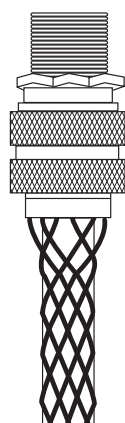

Deluxe Cord
Indoor or outdoor use where subject to moisture, splash, or washdown. Examples are enclosures, crane hoist and pendant drop stations, hand tools, pumps, and processing equipment. Available in straight, 90°, or 45° configurations. See pages T-60 to T-64.



Liquid-Tight, Flexible Metal Conduit
Wiring of machine tools, electrical enclosures, motors, and systems subjected to vibration, flexure, motion, or strain. Available in straight, 90°, or 45° configurations. See pages T-68 to T-70.

Other Specialty Grips

Splicing Grips
Used as temporary splice for cable and wire rope, or as reinforcement to protect cables and hoses. See pages T-13 and T-14.

Conduit Riser Grips
Ideal for supporting electrical wires inside rigid conduit via a supporting ring. See pages T-39 to T-41.

Hose Containment Grips
Used on flexible hose lines to prevent violent whipping of hose in the event of failure at the fitting. See page T-58.

Specifications are subject to change without notice.

Pulling Grips

Overhead, Underground, Commercial Construction, Specialty



Flexible or rotating eyes will mate easily with line stringing swivels for attachment to pulling lines; they have great strength for trouble free pulling jobs

Shoulder protectors contain the cable inside the grip and smooth the passage of the grip over line stringing blocks or conduit bends; they protect the leading edge of the grip from abrasion

The galvanized steel mesh grip provides strength for secure pulling jobs and a slim profile with little build-up; it has flexibility to follow cable path

The multiweave styles available add strength for big pulling jobs and provide positive gripping power

Endless weave allows easy installation onto cable. It has a snag-free low profile; designed to be a reusable tool





Kellems® Wire Management Products Overhead DUA-PULL® Pulling Grips

Flexible Eye, Double Weave Mesh, Galvanized Steel

WARNING!

It is important that you read all breaking strength, safety and technical data relating to this product on pages T-17 through T-27.

DUA-PULL® Grips

DUA-PULL Pulling Grips are the highest strength pulling grips manufactured for overhead transmission line stringing applications. They have a dual function, not provided by any other grip, of working with both bare and insulated conductors and synthetic rope.

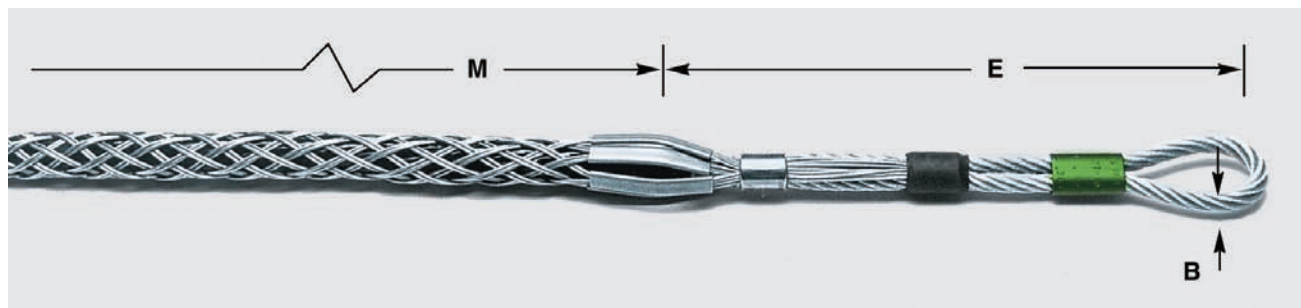

DUA-PULL® Grips

Diameter Range		Approx. Breaking Strength Lbs. (N)	Diameter		Eye B Diameter In. (cm)	Over Cable & Grip** In. (cm)	Diameter Color Code	Catalog Number
Conductor Diameter Inches (cm)	Rope* Diameter Inches (cm)		E In. (cm)	M In. (cm)				
.19"-.37" (.48-.94)	.25"-.65" (.63-1.65)	6,500 (28,912)	10" (25.40)	24" (60.96)	.220" (.56)	.200" (.51)	Black	033271037
.38"-.62" (.97-1.57)	.50"-.90" (1.27-2.29)	14,000 (62,272)	12" (30.48)	36" (91.44)	.375" (.95)	.280" (.71)	Dk Green	033271038
.63"-.87" (1.60-2.21)	.75"-.1.10" (1.90-2.79)	20,000 (88,960)	13" (33.02)	48" (121.92)	.437" (1.11)	.360" (.91)	Red	033271039
.88"-.1.12" (2.24-2.84)	1.00"-.1.50" (2.54-3.81)	30,600 (136,109)	15" (38.10)	60" (152.40)	.500" (1.27)	.500" (1.27)	Dk Blue	033271040
1.13"-.1.37" (2.87-3.48)	1.25"-.1.70" (3.17-4.32)	46,800 (208,166)	18" (45.72)	76" (193.04)	.625" (1.59)	.625" (1.59)	Yellow	033271041
1.38"-.1.90" (3.51-4.38)	1.50"-.2.10" (3.81-5.33)	66,500 (295,792)	24" (60.96)	89" (226.06)	.750" (1.90)	.750" (1.90)	Alum.	033271042

Note: E- Eye length.

M-Mesh length at nominal diameter.

* For rope, select smallest size grip which meets required work load.

** Add to cable or rope diameter.



DUA-PULL® Feed Tube

For Use with DUA- PULL Grip	Rope Diameter Inches (cm)	Feed Tube Length Inches (cm)	Catalog Number
033271037	.25"-.65" (.63-1.65)	28" (71.12)	091061043
033271038	.50"-.90" (1.27-2.29)	40" (101.60)	091061044
033271039	.75"-.1.10" (1.90-2.79)	52" (132.08)	091061045
033271040	1.00"-.1.50" (2.54-3.81)	67" (170.18)	091061046
033271041	1.25"-.1.70" (3.17-4.32)	83" (210.82)	091061047
033271042	1.50"-.2.10" (3.81-5.33)	96" (243.84)	091061048



Kellems® Wire Management Products
Overhead Multiple Strength Pulling Grips
 Flexible or Rotating Eye, Triple, Double, Single Weave, Galvanized Steel



Multiple Strength Style Grips

Multiple Strength Pulling Grips are designed for pulling aluminum or copper bare conductor, ground wires, messenger strands, wire rope and insulated cables.

WARNING!

It is important that you read all breaking strength, safety and technical data relating to this product on pages T-17 through T-27.

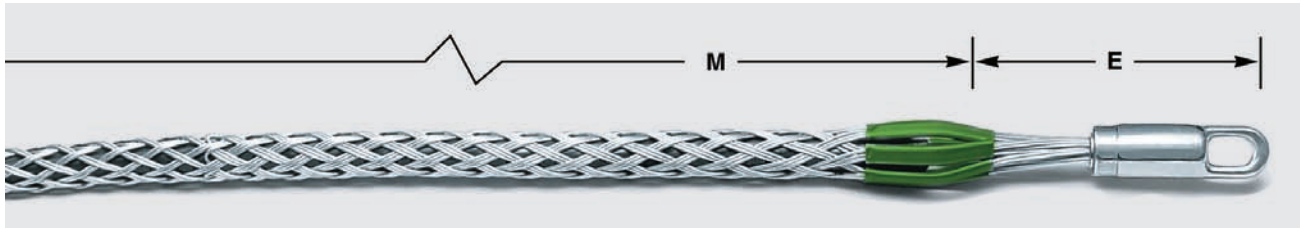

Multiple Strength Grip-Rotating Eye

Cable Diameter Range Inches (cm)	Approx. Breaking Strength Lbs. (N)	E Inches (cm)	M Inches (cm)	Rotating Eye Dia. Inches (cm)	Color Code	Catalog Number
.25"-.49" (.63-1.24)	6,800 (20,567)	5" (12.70)	26" (66.04)	7/8" (2.22)	Dark Green	03302016
.50"-.74" (1.27-1.88)	10,000 (44,480)	6" (15.24)	32" (81.28)	1" (2.54)	Brown	03302018
.75"-.99" (1.90-2.51)	14,400 (64,051)	6" (15.24)	41" (104.14)	1" (2.54)	Light Blue	03302020
1.00"-1.24" (2.54-3.15)	24,600 (109,420)	8" (20.32)	52" (132.08)	1 3/8" (3.49)	Gold	03302022
1.25"-1.49" (3.17-3.78)	30,600 (136,109)	8" (20.32)	56" (142.24)	1 5/8" (4.13)	Black	03302024
1.50"-1.74" (3.81-4.42)	30,600 (136,109)	9" (22.86)	60" (152.40)	1 7/8" (4.76)	Red	03302026
1.75"-2.24" (4.44-5.69)	48,000 (213,504)	10" (25.40)	70" (177.80)	1 7/8" (4.76)	Dark Blue	03302028
2.00"-2.49" (5.08-6.32)	48,000 (213,504)	10" (25.40)	50" (127.00)	1 7/8" (4.76)	Yellow	03302066
2.50"-2.99" (6.35-7.59)	48,000 (213,504)	10" (25.40)	52" (132.08)	1 7/8" (4.76)	Orange	03302097
3.00"-3.49" (7.62-8.86)	48,000 (213,504)	10" (25.40)	54" (137.16)	1 7/8" (4.76)	Aluminum	033021030
3.50"-3.99" (8.89-10.13)	48,000 (213,504)	10" (25.40)	58" (142.24)	1 7/8" (4.76)	Light Green	033021031

Note: E- Eye length.
 M-Mesh length at nominal diameter.

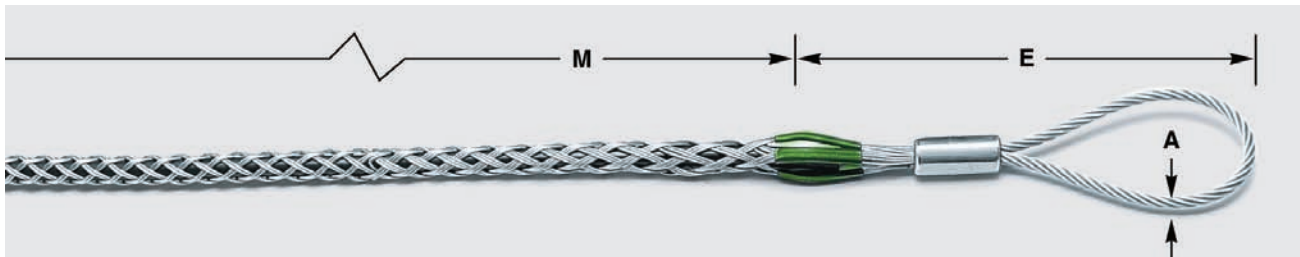

Multiple Strength Grip-Flexible Eye

Cable Diameter Range Inches (cm)	Approx. Breaking Strength Lbs. (N)	E Inches (cm)	M Inches (cm)	A-Eye Dia. Inches (cm)	Color Code	Catalog Number
.25"-.49" (.63-1.24)	6,800 (20,567)	9" (22.86)	26" (66.04)	1/4" (.63)	Dark Green	03302044
.50"-.74" (1.27-1.88)	10,000 (44,480)	9" (22.86)	32" (81.28)	5/16" (.79)	Brown	03302046
.75"-.99" (1.90-2.51)	14,400 (64,051)	11" (27.94)	41" (104.14)	3/8" (.95)	Light Blue	03302048
1.00"-1.24" (2.54-3.15)	24,600 (109,420)	12" (30.48)	52" (132.08)	1/2" (1.27)	Gold	03302050
1.25"-1.49" (3.17-3.78)	30,600 (136,109)	12" (30.48)	56" (142.24)	1/2" (1.27)	Black	03302052
1.50"-1.74" (3.81-4.42)	30,600 (136,109)	12" (30.48)	60" (152.40)	1/2" (1.27)	Red	03302054
1.75"-2.24" (4.44-5.69)	48,000 (213,504)	18" (45.72)	70" (177.80)	5/8" (1.59)	Dark Blue	03302056
2.00"-2.49" (5.08-6.32)	48,000 (213,504)	18" (45.72)	50" (127.00)	5/8" (1.59)	Yellow	033021078
2.50"-2.99" (6.35-7.59)	48,000 (213,504)	18" (45.72)	52" (132.08)	5/8" (1.59)	Orange	033021079
3.00"-3.49" (7.62-8.86)	48,000 (213,504)	18" (45.72)	54" (137.16)	5/8" (1.59)	Aluminum	033021080
3.50"-3.99" (8.89-10.13)	48,000 (213,504)	18" (45.72)	58" (142.24)	5/8" (1.59)	Light Green	033021081

Note: E- Eye length.
 M-Mesh length at nominal diameter.





Kellems® Wire Management Products

Underground K-Type Pulling Grips

Rotating Eye, Double Weave, Galvanized Steel

WARNING!

It is important that you read all breaking strength, safety and technical data relating to this product on pages T-17 through T-27.

K-Type Grips

Kellems® Rotating Eye, K-Type Pulling Grips are made of high strength galvanized steel strand. All Grips feature double weave mesh for greater strength and added mesh contact on the table, to handle longer or heavier pulling jobs. The forged eye mates easily with a swivel or shackle.

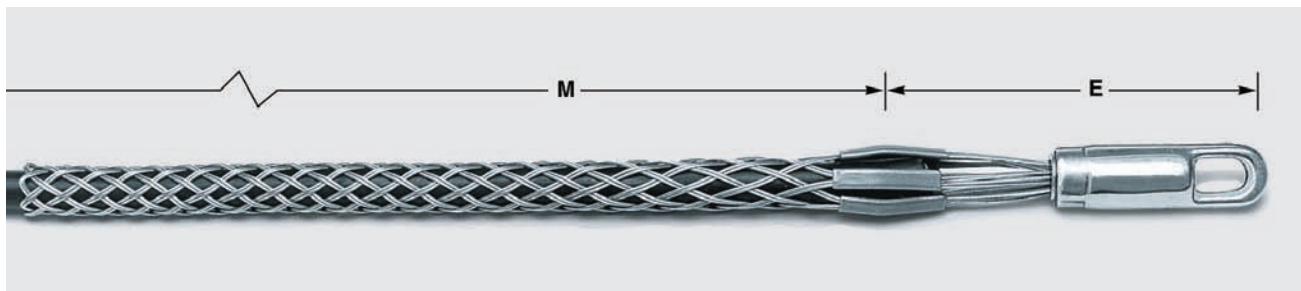

K-Type Grips

Cable Diameter Range Inches (cm)	Approx. Breaking Strength Lbs. (N)	E In. (cm)	M In. (cm)	Rotating Eye Diameter Inches (cm)	Catalog Number
Short					
.50"-.62" (1.27-1.57)	5,600 (24,909)	5" (12.70)	11" (27.94)	7/8" (2.22)	03301001
.63"-.74" (1.60-1.88)	6,800 (30,246)	5" (12.70)	11" (27.94)	7/8" (2.22)	03301002
.75"-.99" (1.90-2.51)	6,800 (30,246)	6" (15.24)	20" (50.80)	1" (2.54)	03301013
1.00"-1.24" (2.54-3.15)	12,800 (56,934)	7" (17.78)	20" (50.80)	1 3/8" (3.49)	03301014
1.25"-1.49" (3.17-3.78)	12,800 (56,934)	7" (17.78)	21" (53.34)	1 3/8" (3.49)	03301016
1.50"-1.99" (3.81-5.05)	16,400 (72,941)	7" (17.78)	25" (63.50)	1 3/8" (3.49)	03301017
2.00"-2.49" (5.08-6.32)	27,200 (120,986)	8" (20.32)	26" (66.04)	1 5/8" (4.13)	03301018
2.50"-2.99" (6.35-7.59)	33,000 (146,784)	10" (25.40)	28" (71.12)	1 7/8" (4.76)	03301019
3.00"-3.49" (7.62-8.86)	41,000 (182,368)	10" (25.40)	30" (76.20)	1 7/8" (4.76)	03301020
3.50"-3.99" (8.89-10.13)	48,000 (213,504)	10" (25.40)	32" (81.28)	1 7/8" (4.76)	03301021
4.00"-4.49" (10.16-11.40)	48,000 (213,504)	10" (25.40)	33" (83.82)	1 7/8" (4.76)	033011017
Standard					
.50"-.62" (1.27-1.57)	5,600 (24,909)	5" (12.70)	16" (40.64)	7/8" (2.22)	03301011
.63"-.74" (1.60-1.88)	6,800 (30,246)	5" (12.70)	16" (40.64)	7/8" (2.22)	03301012
.75"-.99" (1.90-2.51)	9,600 (42,701)	6" (15.24)	32" (81.28)	1" (2.54)	03301024
1.00"-1.49" (2.54-3.78)	16,400 (72,947)	7" (17.78)	33" (83.82)	1 3/8" (3.49)	03301025
1.50"-1.99" (3.81-5.05)	16,400 (72,947)	7" (17.78)	34" (86.36)	1 3/8" (3.49)	03301026
2.00"-2.49" (5.08-6.32)	27,200 (120,986)	9" (22.86)	36" (91.44)	1 5/8" (4.13)	03301027
2.50"-2.99" (6.35-7.59)	33,000 (146,784)	10" (25.40)	38" (96.52)	1 7/8" (4.76)	03301028
3.00"-3.49" (7.62-8.86)	41,000 (182,368)	10" (25.40)	39" (99.06)	1 7/8" (4.76)	03301029
3.50"-3.99" (8.89-10.13)	48,000 (213,504)	10" (25.40)	41" (104.14)	1 7/8" (4.76)	03301030
4.00"-4.49" (10.16-11.40)	48,000 (213,504)	10" (25.40)	42" (106.68)	1 7/8" (4.76)	03301031
4.50"-4.99" (11.43-12.67)	48,000 (213,504)	10" (25.40)	58" (147.32)	1 7/8" (4.76)	03301039
5.00"-5.99" (12.70-15.21)	40,000 (177,920)	10" (25.40)	60" (152.40)	1 7/8" (4.76)	03301047
6.00"-6.99" (15.24-17.75)	54,000 (240,192)	10" (25.40)	66" (167.64)	1 7/8" (4.76)	03301045

Note: E- Eye length.

M-Mesh length at nominal diameter.

See page T-26 for multiple cables in a single pulling grip.



Kellems® Wire Management Products Underground T-Type Pulling Grips

Flexible Eye, Double Weave, Galvanized Steel

T-Type Grips

Kellems® Flexible T-Type Pulling Grips are made of high strength galvanized steel strand. They feature double weave mesh for positive holding power in medium to heavy pulling jobs. The grip eye will easily attach to a swivel.

WARNING!

It is important that you read all breaking strength, safety and technical data relating to this product on pages T-17 through T-27.

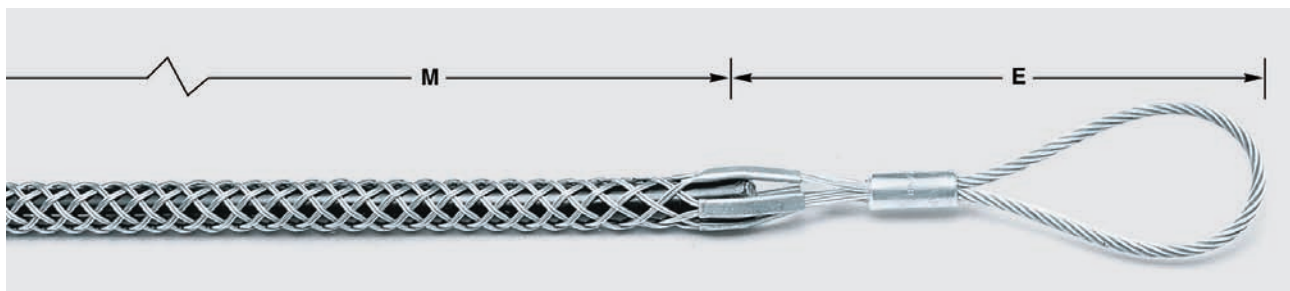

T-Type Grips

Cable Diameter Range Inches (cm)	Approx. Breaking Strength Lbs. (N)	E Inches (cm)	M Inches (cm)	Catalog Number
----------------------------------	------------------------------------	---------------	---------------	----------------

Short

.50"-.62" (1.27-1.57)	4,500 (20,016)	8" (20.32)	21" (53.34)	033041082
.63"-.74" (1.60-1.88)	5,600 (24,909)	8" (20.32)	24" (60.96)	033041083
.75"-.99" (1.90-2.51)	6,800 (30,246)	9" (22.86)	24" (60.96)	033041084
1.00"-1.49" (2.54-3.78)	9,600 (42,701)	9" (22.86)	24" (60.96)	033041085
1.50"-1.99" (3.81-5.05)	16,400 (72,947)	11" (27.94)	24" (60.96)	033041086
2.00"-2.49" (5.08-6.32)	18,500 (82,288)	12" (30.48)	24" (60.96)	033041087
2.50"-2.99" (6.35-7.59)	24,500 (108,976)	12" (30.48)	24" (60.96)	033041088
3.00"-3.49" (7.62-8.86)	24,500 (108,976)	14" (35.56)	24" (60.96)	033041089
3.50"-3.99" (8.89-10.13)	31,000 (137,888)	14" (35.56)	26" (66.04)	033041090

Standard

.75"-.99" (1.90-2.51)	6,800 (30,246)	9" (22.86)	36" (91.44)	033041091
1.00"-1.49" (2.54-3.78)	9,600 (42,701)	9" (22.86)	36" (91.44)	033041092
1.50"-1.99" (3.81-5.05)	16,400 (72,947)	11" (27.94)	36" (91.44)	033041093
2.00"-2.49" (5.08-6.32)	18,500 (82,288)	12" (30.48)	36" (91.44)	033041094
2.50"-2.99" (6.35-7.59)	24,500 (108,976)	12" (30.48)	36" (91.44)	033041095
3.00"-3.49" (7.62-8.86)	24,500 (108,976)	14" (35.56)	36" (91.44)	033041096
3.50"-3.99" (8.89-10.13)	31,000 (137,888)	14" (35.56)	40" (101.60)	033041097

Note: E- Eye length.

M-Mesh length at nominal diameter.

See page T-26 for multiple cables in a single pulling grip.



Kellems® Wire Management Products

Special Purpose Pulling Grips

Non-Conductive and Slack Pulling

WARNING!

It is important that you read all breaking strength, safety and technical data relating to this product on pages T-17 through T-27.

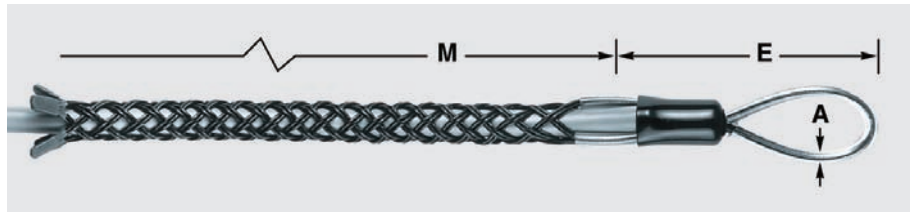

Non-Conductive Grips, Single Eye, Double Weave, Non-Metallic

Kellems® Non-Conductive Pulling Grips, made of a high strength, non-conductive aramid fiber, are available for pulling single cable or cable bundles. Their braided double weave design adds strength and positive holding power.

Cable Diameter Range Inches (cm)	Approx. Breaking Strength Lbs. (N)	E In. (cm)	M In. (cm)	A In. (cm)	Color Code	Catalog Number
.50"- .62" (1.27-1.57)	4,000 (17,792)	5.5" (13.97)	24" (60.96)	.44" (1.12)	Green	03628001
.63"- .74" (1.60-1.88)	5,000 (22,240)	5.5" (13.97)	26" (66.04)	.44" (1.12)	Yellow	03628002
.75"- .99" (1.90-2.51)	6,000 (26,688)	6.0" (15.24)	31" (78.74)	.63" (1.60)	Red	03628003
1.00"-1.24" (2.54-3.15)	6,000 (26,688)	6.5" (16.51)	36" (91.44)	.63" (1.60)	Blue	03628004
1.25"-1.49" (3.17-3.78)	6,000 (26,688)	6.7" (17.02)	41.5" (105.41)	.63" (1.60)	White	03628005
1.50"-1.99" (3.815-05)	6,000 (26,688)	8.0" (20.32)	44.0" (121.76)	.63" (1.60)	Pink	03628006

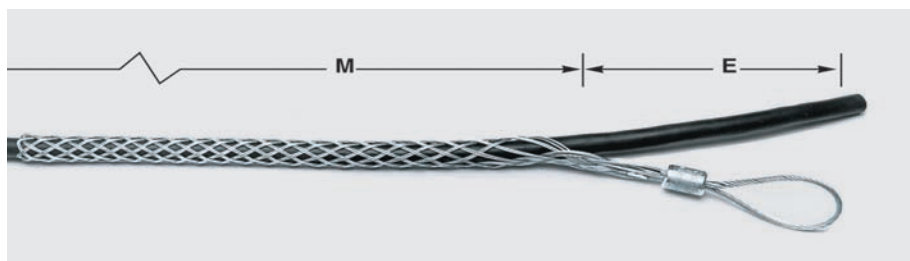

Slack Pulling Grips are offered in three styles made of galvanized steel. The closed type is used when the cable end is accessible. When not accessible, there are split lace and split rod closing styles. All grips feature a single offset eye for easy attachment to a pulling line.

Slack Grip-Closed Mesh, Offset Eye, Double Weave, Galvanized Steel

Cable Diameter Range Inches (cm)	Approx. Breaking Strength Lbs. (N)	E Inches (cm)	M Inches (cm)	Catalog Number
Standard				
.75"- .99" (1.90-2.51)	2,600 (11,565)	7" (17.78)	12" (30.48)	03308003
1.00"-1.24" (2.54-3.15)	4,000 (17,792)	8" (20.32)	15" (38.10)	03308004
1.25"-1.49" (3.17-3.78)	5,400 (24,019)	8" (20.32)	16" (40.64)	03308005
1.50"-1.74" (3.81-4.42)	6,600 (29,357)	8" (20.32)	20" (50.80)	03308006
1.75"-1.99" (4.44-5.05)	10,000 (44,480)	10" (25.40)	18" (45.72)	03308007
2.00"-2.49" (5.08-6.32)	11,000 (48,928)	10" (25.40)	19" (48.26)	03308008
2.50"-2.99" (6.35-7.59)	11,000 (48,928)	10" (25.40)	20" (50.80)	03308009
3.00"-3.49" (7.62-8.86)	14,500 (64,496)	12" (30.48)	21" (53.34)	03308010
3.50"-3.99" (8.89-10.13)	14,500 (64,496)	12" (30.48)	22" (55.88)	03308011

Note: E- Eye length.

M-Mesh length at nominal diameter.

See page T-26 for multiple cables in a single pulling grip.



Kellems® Wire Management Products

Special Purpose Pulling Grips

Slack Pulling

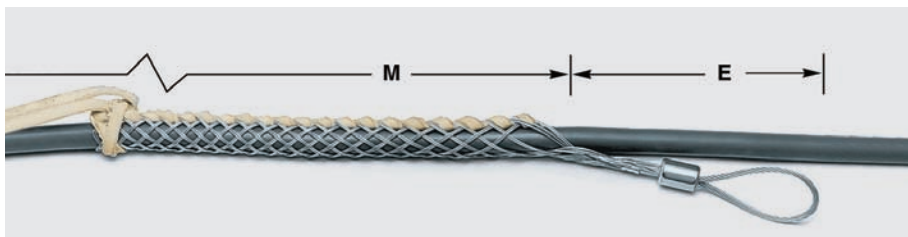

Slack Grip-Split Mesh, Rawhide Lace Closing, Offset Eye, Double Weave, Galvanized Steel

Cable Diameter Range Inches (cm)	Approx. Breaking Strength Lbs. (N)	E Inches (cm)	M Inches (cm)	Catalog Number
Standard				
.75"- .99" (1.90-2.51)	2,500 (11,120)	7" (17.78)	12" (30.48)	03309003
1.00"-1.24" (2.54-3.15)	3,500 (15,568)	8" (20.32)	15" (38.10)	03309004
1.25"-1.49" (3.17-3.78)	4,000 (17,792)	8" (20.32)	16" (40.64)	03309005
1.50"-1.74" (3.81-4.42)	4,000 (17,792)	9" (22.86)	17" (43.18)	03309006
1.75"-1.99" (4.44-5.05)	4,000 (17,792)	10" (25.40)	18" (45.72)	03309007
2.00"-2.49" (5.08-6.32)	4,000 (17,792)	10" (25.40)	19" (48.26)	03309008
2.50"-2.99" (6.35-7.59)	4,000 (17,792)	10" (25.40)	20" (50.80)	03309009

Long

1.50"-1.99" (3.81-5.05)	4,000 (17,792)	9" (22.86)	25" (63.50)	03309015
2.00"-2.49" (5.08-6.32)	4,000 (17,792)	10" (25.40)	26" (66.04)	03309016
2.50"-2.99" (6.35-7.59)	4,000 (17,792)	10" (25.40)	29" (73.66)	03309017
3.00"-3.49" (7.62-8.86)	4,000 (17,792)	12" (30.48)	32" (81.28)	03309018
3.50"-3.99" (8.89-10.13)	4,000 (17,792)	12" (30.48)	35" (88.90)	03309019

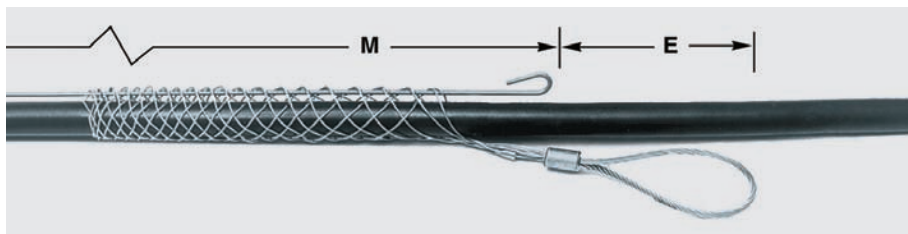

Slack Grip-Split Mesh, Rod Closing, Offset Eye, Single Weave, Galvanized Steel

Cable Diameter Range Inches (cm)	Approx. Breaking Strength Lbs. (N)	E Inches (cm)	M Inches (cm)	Catalog Number
.50"- .61" (1.27-1.55)	1,500 (6,672)	7" (17.78)	6" (15.24)	03310001
.62"- .74" (1.57-1.88)	1,800 (8,006)	7" (17.78)	8" (20.32)	03310002
.75"- .99" (1.90-2.51)	2,200 (9,786)	7" (17.78)	10" (25.40)	03310003
1.00"-1.24" (2.54-3.15)	3,400 (15,123)	8" (20.32)	12" (30.48)	03310004
1.25"-1.49" (3.17-3.78)	4,500 (20,016)	8" (20.32)	14" (35.56)	03310005
1.50"-1.74" (3.81-4.42)	5,800 (25,798)	9" (22.86)	15" (38.10)	03310006
1.75"-1.99" (4.44-5.05)	7,600 (33,805)	10" (25.40)	16" (40.64)	03310007
2.00"-2.49" (5.08-6.32)	9,000 (40,032)	10" (25.40)	19" (48.26)	03310008
2.50"-2.99" (6.35-7.59)	11,000 (48,928)	10" (25.40)	20" (50.80)	03310009
3.00"-3.49" (7.62-8.86)	12,000 (53,376)	12" (30.48)	21" (53.34)	03310010
3.50"-3.99" (8.89-10.13)	12,000 (53,376)	12" (30.48)	24" (60.96)	03310011

Note: E- Eye length.
 M-Mesh length at nominal diameter.
 See page T-26 for multiple cables in a single pulling grip.

WARNING!

It is important that you read all breaking strength, safety and technical data relating to this product on pages T-17 through T-27.

Slack Pulling Grips are offered in three styles made of galvanized steel. The closed type is used when the cable end is accessible. When not accessible, there are split lace and split rod closing styles. All grips feature single offset eye for easy attachment to a pulling line.





Kellems® Wire Management Products

Low Tension Pulling Grips

Flexible Eye, Single Weave, Galvanized Steel

WARNING!

It is important that you read all breaking strength, safety and technical data relating to this product on pages T-17 through T-27.

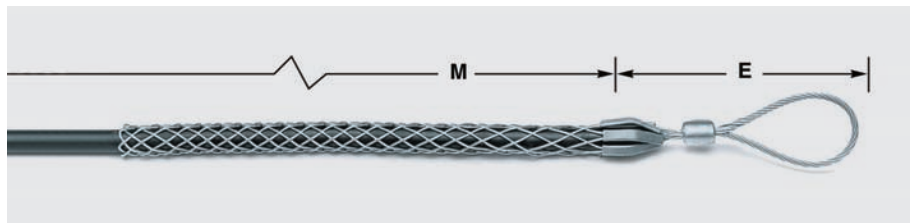

Light Duty Pulling Grips are made of galvanized steel in a single weave construction. They feature a flexible eye for easy attachment to a pulling line.

Light Duty Grips

Cable Diameter Range Inches (cm)	Approx. Breaking Strength Lbs. (N)	E Inches (cm)	M Inches (cm)	Catalog Number
Short				
.50"--.62" (1.27-1.57)	2,800 (12,454)	5" (12.70)	11" (27.94)	03303001
.63"--.74" (1.60-1.88)	2,800 (12,454)	5" (12.70)	11" (27.94)	03303002
.75"--.99" (1.90-2.51)	4,000 (17,792)	6" (15.24)	12" (30.48)	03303003
1.00"-1.24" (2.54-3.15)	5,300 (23,574)	7" (17.78)	13" (33.02)	03303004
1.25"-1.49" (3.17-3.78)	5,300 (23,574)	7" (17.78)	14" (35.56)	03303005
1.50"-1.74" (3.81-4.42)	6,800 (30,246)	8" (20.32)	15" (38.10)	03303006
1.75"-1.99" (4.44-5.05)	8,500 (37,808)	9" (22.86)	17" (43.18)	03303007
2.00"-2.49" (5.08-6.32)	8,500 (37,808)	9" (22.86)	18" (45.72)	03303008

Junior Pulling Grips feature a strong galvanized steel, single weave mesh. A flexible eye easily attaches to a pulling line, snake or fish tape.

Standard

.50"--.62" (1.27-1.57)	2,800 (12,454)	5" (12.70)	16" (40.64)	03303010
.63"--.74" (1.60-1.88)	2,800 (12,454)	5" (12.70)	16" (40.64)	03303011
.75"--.99" (1.90-2.51)	4,000 (17,792)	6" (15.24)	20" (50.80)	03303012
1.00"-1.24" (2.54-3.15)	6,800 (30,246)	7" (17.78)	20" (50.80)	03303013
1.25"-1.49" (3.17-3.78)	6,800 (30,246)	7" (17.78)	21" (53.34)	03303015
1.50"-1.99" (3.81-5.05)	6,800 (30,246)	8" (20.32)	23" (58.42)	03303016
2.00"-2.49" (5.08-6.32)	8,500 (37,808)	9" (22.86)	25" (63.50)	03303017
2.50"-2.99" (6.35-7.59)	10,600 (47,149)	9" (22.86)	27" (68.58)	03303018
3.00"-3.49" (7.62-8.86)	14,700 (65,386)	10" (25.40)	30" (76.20)	03303019
3.50"-3.99" (8.89-10.13)	14,700 (65,386)	10" (25.40)	32" (81.28)	03303029

Junior Grip Kit

Junior Grip Kit contains 6 grips, one of each size. Catalog number 033051114.

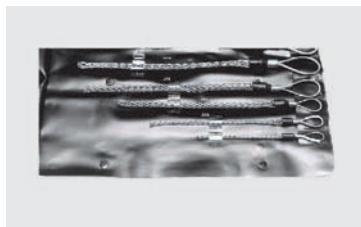

Note: See page T-26 for multiple cables in a single pulling grip.

See page T-27 for building wire selection chart.

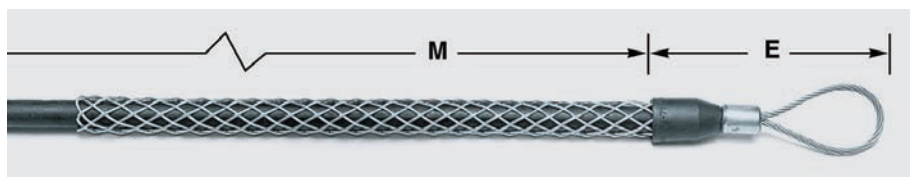

Junior Pulling Grips

Cable Diameter Range Inches (cm)	Approx. Breaking Strength Lbs. (N)	E Inches (cm)	M Inches (cm)	Model	Catalog Number
.19"--.24" (.48-.61)	400 (1,779)	3¼" (8.25)	4¼" (10.79)	J19	03305011*
.25"--.37" (.63-.94)	450 (2,002)	3¼" (8.25)	4¼" (10.79)	J25	03305001
.38"--.49" (.97-1.24)	900 (4,003)	3¾" (9.52)	7" (17.78)	J37	03305002
.50"--.62" (1.27-1.57)	1,300 (5,782)	4¼" (10.79)	8½" (21.59)	J50	03305003
.63"--.74" (1.60-1.88)	1,950 (8,674)	5" (12.70)	10" (25.40)	J62	03305004
.75"--.99" (1.90-2.51)	2,800 (12,454)	5¾" (14.60)	10" (25.40)	J75	03305005
1.00"-1.24" (2.54-3.15)	3,900 (17,347)	6½" (16.51)	11½" (29.21)	J100	03305006

Note: E- Eye length.

M-Mesh length at nominal diameter.

* Not included in Junior Grip Kit, 033051114.



Kellems® Wire Management Products

Wire Rope Splicing Grips

Triple, Double, Single Weave, Galvanized Steel



WARNING!

It is important that you read all breaking strength, safety and technical data relating to this product on pages T-17 through T-27.

Regular Wire Rope Grips

Cable Diameter Range Inches (cm)	Approx. Breaking Strength Lbs. (N)	Approx. Length Of Grip Feet (m)	Catalog Number
5/16" - 5/8" (1.43-1.59)	7,500 (33,360)	5.75 (1.75)	03316001
3/4" - 7/8" (1.90-2.22)	12,500 (55,600)	6.75 (1.90)	03316002
1" - 1 1/8" (2.54-2.86)	16,000 (71,168)	7.00 (2.13)	03316003
1 1/4" - 1 5/8" (3.17-3.49)	20,000 (88,960)	8.00 (2.44)	03316004
1 5/8" - 1 1/2" (3.49-3.81)	20,000 (88,960)	8.00 (2.44)	03316006

Kellems® Wire Rope Grips are made of high strength galvanized steel strand in a construction of triple, double and single weave for superior gripping ability. They are available with or without a rotating barrel which will help eliminate twist in the old rope from being transferred to the new rope.



Rotating Wire Rope Grips

Cable Diameter Range Inches (cm)	Approx. Breaking Strength Lbs. (N)	Approx. Length Of Grip Feet (m)	Barrel Dimensions Lgth. x O.D. In. (cm)	Catalog Number
7/16" - 1/2" (1.11-1.27)	5,000 (22,240)	5.33 (1.63)	3.00" (7.62) x .87" (2.21)	03317001
5/16" - 5/8" (1.43-1.59)	7,500 (33,360)	5.83 (1.78)	4.25" (10.79) x 1.00" (2.54)	03317002
3/4" - 7/8" (1.90-2.22)	12,500 (55,600)	6.50 (1.98)	4.25" (10.79) x 1.00" (2.54)	03317003
1" - 1 1/8" (2.54-2.86)	16,000 (71,168)	8.67 (2.64)	5.50" (13.97) x 1.37" (3.48)	03317004
1 1/4" - 1 5/8" (3.17-3.49)	20,000 (88,960)	9.00 (2.74)	5.50" (13.97) x 1.37" (3.48)	03317005
1 1/2" - 1 3/4" (3.81-4.44)	20,000 (88,960)	11.00 (3.35)	5.50" (13.97) x 1.37" (3.48)	03317006



Kellems® Wire Management Products

Cable Splicing Grips

Double Weave, Galvanized Steel / Single Weave, Galvanized Steel

WARNING!

It is important that you read all breaking strength, safety and technical data relating to this product on pages T-17 through T-27.



Splicing Grip

Splicing Grips are made of galvanized steel in double weave mesh construction. They are available in various lengths and sizes to suit most applications.

Double Weave Tube

Cable Diameter Range Inches (cm)	.37"-.49" (.94-1.24)	.50"-.61" (1.27-1.55)	.62"-.74" (1.57-1.88)	.75"-.99" (1.90-2.51)	1.00"-1.49" (2.54-3.78)
Approx. Breaking Strength Lbs. (N)	3,500 (15,568)	3,500 (15,568)	4,400 (19,571)	7,500 (33,360)	10,000 (44,480)
Mesh Length Inches (cm)	Catalog Number				
18" (45.72)	013041330	01304064	01304009	—	—
24" (60.96)	—	01304011	01304013	01304010	01304015
36" (91.44)	—	—	013041234	01304054	01304055
48" (121.92)	—	—	—	01304017	01304029
72" (182.88)	—	—	—	01304037	013041333

Junior Splicing Grips, Single Weave

Junior Splicing Grips are made of galvanized steel and are designed for use in very light duty and small splicing jobs.



Junior Tube

Cable Diameter Range Inches (cm)	Approx. Breaking Strength Lbs. (N)	Length @ Nom Diameter Inches (cm)	Catalog Number
.18"-.24" (.46-.61)	400 (1,779)	7" (17.78)	01301008
.25"-.36" (.63-.91)	400 (1,779)	8" (20.32)	01301013



Punch-Lok® Bands

Punch-Lok Bands are applied over the tail of a grip to prevent the mesh from being tripped or pulled loose. Also, they assure full gripping action by locking the mesh of the tail in tight contact with the cable or rope.

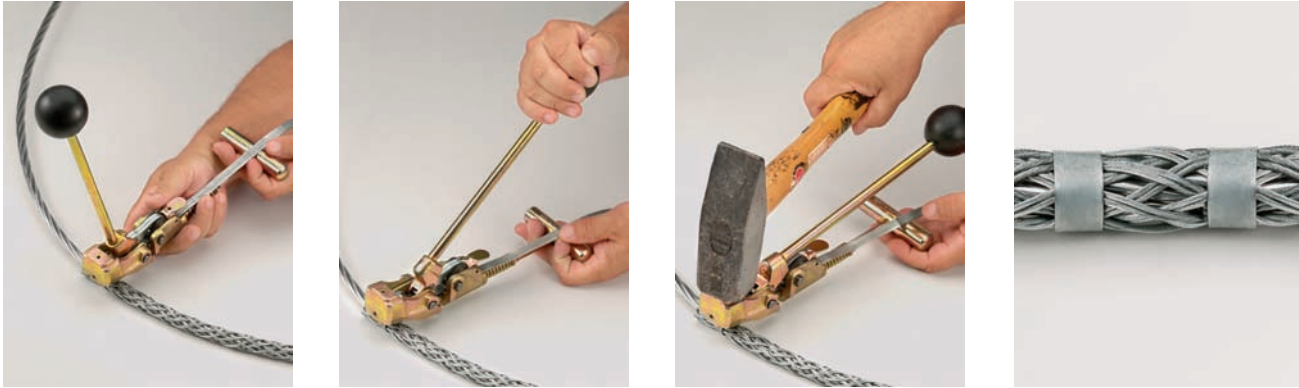

When the tail of a grip is the leading end, the bands are particularly important to prevent accidental release caused by tripping on obstructions. A conductor-to-conductor (double-socking) pulling operation is a good example: where two grips connect two conductors to form a temporary splice. Bands should be applied to the ends of the grips as illustrated herein. It is also common practice to tape over the banded tail area to assure smooth passage through the sheaves. The conductor should be installed in the grip up to the elbows of the aluminum shoulders in order to assure full and complete gripping action.

Punch-Lok Bands

Grip Banding Range Inches (cm)	Band Width Inches (cm)	Band Inside Diameter Inches (cm)	Model	Catalog Number
¼"-1½" (.63-2.86)	⅜" (.95)	1⅜" (3.49)	0-311	20320050
1⅞"-1⅝" (2.86-4.13)	⅜" (.95)	2" (5.08)	0-316	20320051
1⅝"-2¼" (4.13-5.71)	⅝" (1.59)	2½" (6.35)	0-10	20320052
2¼"-3½" (5.71-8.89)	⅝" (1.59)	4" (10.16)	0-16	20320053
3½"-5" (8.89-12.70)	⅝" (1.59)	6" (15.24)	0-24	20320054

Accessories

Punch-Lok Tools

Description	Catalog Number
P-1000 for use with ⅝" width Banding tool.	20320048
P-38 for use with ⅜" and ⅝" width Banding tool for tight spaces.	20320047

Note: In all cases two Punch-Lok Bands should be double wrapped approximately one inch to two inches (2.54cm to 5.08cm) from the grip's tail. Banding is required to ensure maximum reliability and guard against accidental release.

Punch-Lok® is a registered trademark of Punch-Lok Inc.



Kellems® Wire Management Products

Swivels

Pulling Grips Accessories

WARNING!

It is important that you read all breaking strength, safety and technical data relating to this product on pages T-17 through T-27.



20308001A

Stainless Steel Swivels

Swivels are essential to the efficiency and safety of any high tension application. They are particularly important where continuous pulls develop higher and higher torque levels. Torque is intensified by the pull-resistance of the cable itself and the resistance of the high tension controlling equipment regulating line sag. Ball bearing swivels release torque and prevent it from reaching dangerous levels that can damage the cable and obstruct the lines.

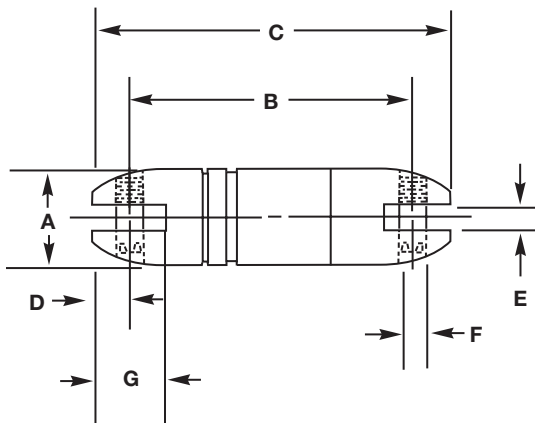

Stainless Steel Swivels

Maximum Safe Working Load Lbs. (N)	Dimensions in Inches (cm)							Model	Catalog Number
	A	B	C	D	E	F	G		
2,250 (10,000)	7/8" (2.22)	2 1/2" (6.35)	3 3/8" (8.57)	7/16" (1.11)	3/8" (0.95)	5/16" (0.79)	3 1/32" (2.46)	A-13L	20308001A
5,000 (22,240)	1 1/4" (3.17)	3 11/16" (9.37)	4 3/4" (12.06)	1 7/32" (1.35)	1 7/32" (1.35)	1 3/32" (1.03)	1 9/32" (3.25)	BB-13L	20308002A
9,000 (40,030)	1 1/2" (3.81)	4 1/4" (10.79)	5 5/8" (14.29)	1 1/16" (1.75)	1 9/32" (1.51)	1/2" (1.27)	1 9/16" (3.97)	B-13L	20308003A
10,000 (44,480)	1 5/8" (4.13)	4 1/2" (11.43)	6" (15.24)	3/4" (1.90)	1 1/16" (1.75)	5/8" (1.59)	2 3/32" (4.36)	C-13L	20308004A
30,000 (133,440)	2 3/8" (6.03)	7 5/8" (19.37)	10" (25.40)	1 3/16" (3.02)	1 1/32" (2.62)	7/8" (2.22)	2 25/32" (7.06)	D-13L	20308005A



Kellems® Wire Management Products

Technical Information

Pulling Grips

Kellems Pulling Grips are reusable tools for pulling electrical cable, bare conductor or rope. They are easy and fast to install, providing the user with a smooth, slim profile that allows for easy passage through ducts, conduit, blocks and sheaves. Kellems Pulling Grips are made of the highest quality galvanized steel strand which assures the user of a long lasting grip. There is a Kellems Pulling Grip for every pulling job.

CAUTION: It is very important to comply with all of the following precautions. Failure to do so may result in property damage, personal injury or death.

1. Pulling grips are to be installed by a qualified individual in accordance with all applicable national and local safety, electrical and rigging codes.
2. Ensure that the correct grip is selected for your specific needs.
3. Do not use a pulling grip for any application other than pulling cable.
4. Thoroughly examine the grip for damage. Do not use a damaged grip.
5. Ensure that the recommended work load of the grip is suitable for the application. Never use grips at their approximated rated breaking strength. A safety factor of 5 is recommended for pulling grips.
6. Do not alter grips in any way. For example, do not modify pulling eyes, shoulders, fittings or lugs.
7. Do not attach any type of pulling hardware to any point on the grip other than the pulling eye. The pulling eye is the only acceptable means of attachment to external hardware.
8. Always apply 2 bands at 1" and 2" respectively, from the tail end of the mesh to guard against accidental release of the grip. Accidental release can occur if an object contracts and pushes against the tail end of the mesh, thereby expanding and releasing its hold.

Select The Correct Pulling Grip

Each Kellems Grip is designed to work on a specific range of cable diameters.

Step 1 Refer to the chart below to determine the style of grip best suited for your application.

Step 2 Determine your cable outside diameter.

Step 3 Find the grip size that encompasses your cable diameter.

Step 4 Estimate the tension to be put on the grip, establish the working load you require and compare this to the listed approximate breaking strength of the grip to insure that the grip will be strong enough. Refer to page T-18 for safety and working load factors.

Pulling Grip Selection Chart

Grip Style	Application	Page Number
DUA-PULL®, flexible eye	Extra high strength overhead transmission line stringing for bare or insulated conductor and synthetic rope.	T-6
Multiple strength, flexible eye	Normal overhead transmission and distribution line stringing for bare or insulated conductor.	T-7
Multiple strength, rotating eye	Normal overhead transmission and distribution line stringing for bare or insulated conductor.	T-7
K-type grip, rotating eye	Underground power cables and communication lines. Service lines into factories.	T-8
T-type grip, flexible eye	Underground power cables and communication lines. Service lines into factories.	T-9
Non-conductive, flexible eye	Pull insulated distribution cable into place.	T-10
Slack pulling, closed mesh	Remove underground cable. For pulling slack in final placement of new cable when end of cable is available.	T-10
Slack pulling, split mesh, rawhide lace closing	Remove underground cable. For pulling slack in final placement of new cable when end of cable is not available.	T-11
Slack pulling, split mesh, rod closing	Remove underground cable. For pulling slack in final placement of new cable when end of cable is not available, with rod closing for quick installation.	T-11
Light duty, flexible eye	Light pulling, underground electrical construction. Industrial plant wiring and rewiring jobs.	T-12
Junior, flexible eye	Connect bundled insulated building wire to a pulling tape. Pull wire through conduit.	T-12
Regular and rotating wire rope	Restraining wire rope in cranes and oil rigs.	T-13
Splicing	Temporary splice for cable or wire rope.	T-14
Pulling Grip Accessories	Tools, bands, swivels.	T-15, T-16
Fiber Optic Cable Pulling Grips	Pull fiber optic cable into place overhead, underground or through duct and conduit.	T-50, T-51, T-52



Kellems® Wire Management Products

Technical Information

Pulling Grips

Safety And Working Load Factors For Wire Mesh Grips

The broad application of Kellems grips on a wide variety of objects requires that adequate safety factors be used to establish working loads. The approximate breaking strength of a Kellems grip represents an average calculation based on data established from actual direct tension testing done in our engineering laboratories.

It is impossible to catalog or guarantee a safety factor suitable for all applications as operating conditions are never the same. The tension, diameter, movement, number of objects gripped, gripping surface, and the attachments used are just some of the factors which vary with each application. These factors, together with the effects of abrasion, corrosion, prior use or abuse and any other variables

of a specific application, must be considered by the user and the grip replaced as appropriate. Where the conditions of the application are not well defined or known, or where risk of injury to persons or property is involved, a greater safety factor should be utilized.

Under normal conditions, Kellems' recommended factor of safety is five for catalog listed pulling grips, and ten for catalog listed support grips.

Any warranty as to quality, performance or fitness for use of grips is always premised on the condition that the published breaking strengths apply only to new, unused grips, and that such products are properly stored, handled, used, maintained and inspected by the user at a frequency appropriate for the use and condition of the grip.

Examples

Grip Style	Approx. Breaking Strength Lbs. (N)	Safety Factor	Max. Rec. Load Lbs. (N)	Catalog Number
Pulling Grips	27,200 (120,986)	5	5,440 (24,197)	03301027
Support Grips	1,610 (7,161)	10	161 (716)	02201018

The maximum recommended working load then is the tension to be exerted on the grip in application with a margin of safety to take care of unforeseen and unusual circumstances.

It is the end-user's decision to determine how much of a safety factor is acceptable for the application.

The metric unit of measure (force) for breaking strength and load is newtons (N). To convert from newtons to the metric unit of weight (kilograms) the conversion factor is 9.808 newtons/kilogram.

Pulling Grip Materials

Material	Features	Product Group
Galvanized steel wire	<ul style="list-style-type: none"> • High strength • Not subject to continuous outside environment 	<ul style="list-style-type: none"> • Pulling grips • Wire rope grips • Splicing grips
Non-metallic strand	<ul style="list-style-type: none"> • Superior flex life • Non-conductive • Corrosion resistant • Moderate strength 	<ul style="list-style-type: none"> • Non-conductive pulling grips

Approvals

UL and CSA Certification is indicated on appropriate product catalog pages.



Kellems® Wire Management Products

Technical Information

Pulling Grips

Overhead Pulling DUA-PULL® Grips

DUA-PULL Pulling Grips are the highest strength pulling grips manufactured for overhead transmission line stringing applications. They have a dual function of working with both bare and insulated conductors and synthetic rope, not provided by any other grip. Kellems' patented two-over, two-under weave design gives exceptional strength and gripping ability by putting more steel mesh in contact with the cable or rope surfaces.

THIS IS THE ONLY PULLING GRIP RECOMMENDED FOR USE ON SYNTHETIC ROPE.

Application

The DUA-PULL Grips are primarily used in overhead transmission line construction where loads and safety considerations require an extra high strength grip. They are most commonly used for attaching pulling lines to conductors, conductors to running boards and "double socking" for conductor-to-conductor connections. The DUA-PULL line accommodates ACSR, ACAR, all aluminum and copper conductors. Also, the grips accommodate ground wires, messenger strands, wire ropes and synthetic ropes.

Benefits

- Made of high strength galvanized steel strand.
- Recommended for pulling bare or insulated conductor, wire rope and synthetic rope.
- DUA-PULL mesh design offers the greatest holding power for all pulling applications.
- Each grip size is color coded for fast and accurate identification and selection.
- Will mate with swivels. See page T-16.

Feed Tubes

The Kellems Feed Tube is used when assembling synthetic rope into the DUA-PULL Grip. It is required on the largest two sizes of DUA-PULL Grips. Feed Tubes are available for use on all size DUA-PULL Grips.

Benefits

- Saves time, allowing fast, easy assembly.
- Can be reused if not damaged.

Note: 1. Do not run grips or swivels over bullwheels while under tension.

2. Two Punch-Lok® bands should be firmly attached approximately 1" and 2" (2.54cm and 5.08cm) from the grip's tail.

Banding is required to ensure maximum reliability and guard against accidental release. See page T-15.

3. Double braided rope, such as 2-in-1 type, should be back spliced for approximately 2/3 of the mesh length for best gripping results. Grip size should be selected by diameter of back splice.



Kellems® Wire Management Products

Technical Information

Pulling Grips

Overhead Pulling Multiple Strength Grips

Multiple Strength Pulling Grips are designed for pulling aluminum or copper bare conductor, ground wires, messenger strands, wire rope and insulated cables. They are made of high strength galvanized steel strand and feature a multi-weave mesh construction of single, double and triple weave for firm holding power.

Application

Kellems Multiple Strength Grips are ideal for overhead transmission and distribution line stringing where moderate loading is anticipated. They are economical tools for attaching conductors to pulling lines and double socking for conductor-to-conductor connections.

Rotating Eye Feature

Multiple Strength Grips are available with a forged steel rotating eye which can be attached to a swivel. The forged eye is durable, compact and streamlined and will thread through blocks and sheaves without binding. The rotating eye is not a swivel and will not turn while under tension; it can turn to relieve pulling torque when tension is relaxed. If constant swivel action is required, a swivel should be used. For rotating eye dimensions, see page T-21. For swivels, see page T-16.

Flexible Eye Feature

Multiple Strength Grips are also available with a flexible, patented wire rope eye. This compact eye will mate with a swivel, and pass through blocks and sheaves without binding.

Benefits

- Economical, high strength pulling tool.
- Multi-weave construction provides greater strength and holding power.
- Endless Weave Grip end lies flat on the cable and will not snag.

Note: 1. Do not run grips or swivels over bullwheels while under tension.

2. Two Punch-Lok® bands should be firmly attached approximately 1" and 2" (2.54cm and 5.08cm) from the grip's tail. Banding is required to ensure maximum reliability and guard against accidental release. See page T-15.



Underground Pulling K-Type and T-Type Grips

K-Type Application

Rotating Eye, K-Type Pulling Grips are specially designed for use in the installation of underground power cables, communication lines and service lines into factories, shopping centers, construction projects and general underground electrical construction.

Rotating Eye Feature

K-Type Grips come equipped with a forged steel rotating eye which can be attached to a swivel. The forged eye is durable, compact and streamlined, and will thread through blocks and sheaves without binding. **The rotating eye is not a swivel and will not turn while under tension;** it can turn to relieve pulling torque when the tension is relaxed. If constant swivel action is required, a swivel should be used. For swivels, see page T-16.

Benefits

- An economical tool for pulling cable.
- Safe, rugged and dependable.
- Equipped with a rotating eye for spin out of pulling torque after load release.
- Easily installed and removed.

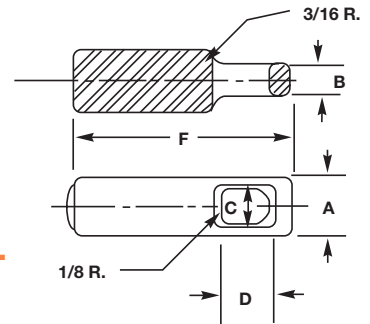

Rotating Eye Dimensions

Rotating Eye Dimensions Inches (cm)	A	B	C	D	F
7/8" (2.22)	7/8" (2.22)	9/32" (.71)	1/2" (1.27)	7/8" (2.22)	2 5/8" (6.67)
1" (2.54)	1" (2.54)	1/2" (1.27)	9/16" (1.43)	1 3/16" (2.06)	3 1/2" (8.89)
1 3/8" (3.49)	1 3/8" (3.49)	1/2" (1.27)	1 1/16" (1.75)	1" (2.54)	4 1/2" (11.43)
1 5/8" (4.13)	1 5/8" (4.13)	5/8" (1.59)	7/8" (2.22)	1 3/16" (3.02)	5 5/16" (13.49)
1 7/8" (4.76)	1 7/8" (4.76)	2 1/32" (1.67)	1" (2.54)	1 3/8" (3.49)	6 1/8" (15.56)

T-Type

Kellems Flexible T-Type Pulling Grips are made of high strength galvanized steel strand. They feature double weave mesh for positive holding power in medium to heavy pulling jobs. The grip eye will easily attach to a swivel.

Application

T-Type Pulling Grips are used for the installation of underground power cables, communication lines and service lines into factories, construction projects and for general underground electrical construction. Available in two mesh lengths, short for medium pulls, and standard for general purpose pulling.

Benefits

- Will pull a single cable or cable bundles.
- Patented flexible eye design provides flexibility to follow line of pull.
- A dependable, reusable pulling tool.
- Easily installed and removed.
- Mates easily with a swivel. See page T-16.



Kellems® Wire Management Products

Technical Information

Pulling Grips

Special Purpose Grips

Non-Conductive Pulling Grips

Kellems Non-Conductive Pulling Grips, made of a high strength, non-conductive aramid fiber, are available for pulling single cable or cable bundles. Their braided double weave design adds strength and positive holding power.

Application

Kellems Non-Conductive Pulling Grips were developed for use by utilities for pulling overhead distribution lines in close proximity to energized lines and hardware.

Benefits

- Color coded for fast on-site selection.
- Extra flexibility for easy installation.
- Non-metallic mesh provides for safe pulls over "hot" areas.
- Pellethane jacketed aramid fiber mesh resists abrasion.
- Grips are corrosion resistant.

Note: Taping is required to guard against accidental release and to insure maximum reliability. Apply vinyl plastic electrical tape starting 2" to 3" (5.08cm to 7.62cm) from the tail of the grip onto 2" to 3" (5.08cm to 7.62cm) of cable.

Slack Pulling Grips

Slack Pulling Grips are offered in three styles made of galvanized steel. The closed type is used when the cable end is accessible. When not, there are split lace and split rod closing styles. All grips feature single offset eye for easy attachment to a pulling line.

Application

Slack Grips are widely used in pulling slack for final placement of under ground cable after it has been pulled in. They are also used for removing cable. Standard mesh lengths are generally used in restricted space for short pulls. Longer lengths are used for higher pulling loads where space is not restricted.

Benefits

- Easy attachment to pulling lines.
- Reusable rawhide lace for lace closure.
- Galvanized steel for strength.

*Note: 1. Replacement rawhide lace. Catalog number 20920002.
2. See page T-44 for lace and rod closing instructions.*



Commercial Construction/Light Duty Grips

Light Duty Pulling Grips

Light Duty Pulling Grips are made of galvanized steel in a single weave construction. They feature a flexible eye for easy attachment to a pulling line.

Application

Light Duty Grips are used in general underground electrical construction where pulling tensions are low. They are easy tools to use in wiring industrial plants and commercial buildings.

Benefits

- Perfect tools for light pulling jobs.
- Installs easily on cable.
- Strong, galvanized steel construction.

Junior Duty Pulling Grips

Junior Pulling Grips feature a strong galvanized steel, single weave mesh. A flexible eye easily attaches to a pulling line, snake or fish tape.

Application

Designed to pull building wire, Junior grips are safe tools to use in pulling wire at low tension through conduit during electrical construction.

Benefits

- Installs easily over building wire.
- Strong secure grip.
- Reusable.
- Pulls single cable or cable bundles.

Junior Grip Kit

Junior Grip Kit contains 6 grips, one of each size. Catalog number **033051114**.

Note: See page T-27 for building wire selection chart.



Kellems® Wire Management Products

Technical Information

Splicing Grips

Splicing Grips

Wire Rope Splicing

Kellems Wire Rope Grips are made of high strength galvanized steel strand in a construction of triple, double and single weave for superior gripping ability. They are available with or without a rotating barrel which will help eliminate twist in the old rope from being transferred to the new rope.

Application

Wire Rope Grips are used for changing wire rope on oil derricks, large cranes, overhead cranes and drag lines. It provides a quick, safe, inexpensive temporary splice. By installing the used wire rope in one end and the new rope in the other, the new wire rope can be pulled in as the old one is pulled out.

Benefits

- High strength for secure pulling.
- Easy installation.
- Flexible to pass through sheaves and blocks.

*Note: 1. During installation each end of the grip should be banded and taped down securely over the rope to insure smooth passage through sheaves and to guard against accidental release. See page T-15 for end bands.
2. The rotating barrel is not a swivel and will not turn while under tension. It can turn to relieve pulling torque when tension is relaxed.*

Cable Splicing

Splicing Grips are made of galvanized steel in double or single weave mesh construction. They are available in various lengths and sizes to suit most applications.

Application

Splicing Grips are used as a temporary splice for rope, cable or wire rope. They can also be used as cable reinforcement, and can act as a shield to protect cables and hoses from abrasion.

Benefits

- Easily installed or removed.
- Galvanized steel construction for strength.
- Flexible to follow cable path.

*Note: 1. During installation, each end of the splicing grip should be banded and taped down securely to the cable to insure smooth passage with the cable and guard against accidental release.
2. See page T-15 for end bands.*



Accessories

Punch-Lok® Bands

Punch-Lok Bands are applied over the tail of a grip to prevent the mesh from being tripped or pulled loose. Also, they assure full gripping action by locking the mesh of the tail in tight contact with the cable or rope.

When the tail of a grip is the leading end, the bands are particularly important to prevent accidental release caused by tripping on obstructions. A conductor-to-conductor (double-socking) pulling operation is a good example: where two grips connect two conductors to form a temporary splice. Bands should be applied to the ends of the grips as illustrated on page T-15. It is also common practice to tape over the banded tail area to assure smooth passage through the sheaves.

The conductor should be installed in the grip up to the elbows of the aluminum shoulders in order to assure full and complete gripping action. The banding procedure is then followed as illustrated on page T-15.

Note: In all cases two Punch-Lok Bands should be double wrapped approximately 1" to 2" (2.54cm to 5.08cm) from the grip's tail. Banding is required to ensure maximum reliability and guard against accidental release.

Swivels

Swivels are essential to the efficiency and safety of any high tension application. They are particularly important where continuous pulls develop higher and higher torque levels. Torque is intensified by the pull-resistance of the cable itself and the resistance of the high tension controlling equipment regulating line sag.

Ball bearing swivels release torque and prevent it from reaching dangerous levels that can damage the cable and obstruct the lines as it passes through sheaves, wheels or blocks.

Punch-Lok® is a registered trademark of Punch-Lok Inc.



Kellems® Wire Management Products

Technical Information

Pulling Grips

Multiple Cable Selection Charts for Cables and Wires of Unequal Diameters

How to choose the correct grip size:

1. Find the Grip Circumference Range by measuring the circumference of the bundle of different diameter cables to be gripped (see illustration).
2. Divide the bundle circumference by 3.14 to determine the diameter.
3. Choose a grip offering a range of cable diameters the same as the cable diameter.

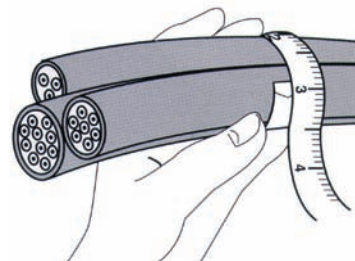

For Pulling Grips*

CAUTION: When a grip is used on multiple cables, the tail end of the grip should be banded after positioning on the cables.

For Cables of Equal Diameters

Under "Number of Cables in One Grip", find the diameter of your single cable in vertical column. Read the grip diameter range to the right.

If your diameter is the maximum of the range shown, go to the next larger size for Split Grips, stay with the same size for Closed Grips.

Example: 3 cables, each with .89" (2.26cm) diameter, for a Closed Grip select the 1.50"-1.74" (3.81cm-4.42cm) range, for a Split Grip select the 1.75"-1.99" (4.44cm-5.05cm) range.

Number of Cables in One Grip

2	3	4	5	6 and 7	8	9	Grip Dia. Range Inches (cm)
.30-.38 (.76-.97)	.25-.31 (.63-.79)	.22-.27 (.56-.69)	.19-.24 (.48-.60)	.17-.22 (.43-.56)	.15-.19 (.38-.48)	.14-.18 (.36-.46)	.50-.61 (1.27-1.55)
.38-.44 (.97-1.12)	.31-.36 (.79-.91)	.27-.31 (.69-.79)	.24-.29 (.61-.74)	.22-.26 (.56-.66)	.19-.23 (.48-.58)	.18-.21 (.46-.53)	.62-.74 (1.57-1.88)
.44-.59 (1.12-1.50)	.36-.49 (.91-1.24)	.31-.42 (.79-1.07)	.29-.38 (.74-.97)	.26-.34 (.66-.86)	.23-.31 (.58-.79)	.21-.28 (.53-.71)	.75-.99 (1.90-2.51)
.59-.75 (1.50-1.90)	.49-.63 (1.24-1.60)	.42-.54 (1.07-1.37)	.38-.48 (.97-1.22)	.34-.43 (.86-1.09)	.31-.39 (.79-.99)	.28-.35 (.71-.89)	1.00-1.24 (2.54-3.15)
.75-.90 (1.90-2.29)	.63-.76 (1.60-1.93)	.54-.65 (1.37-1.65)	.48-.58 (1.22-1.47)	.43-.52 (1.09-1.32)	.39-.46 (.99-1.17)	.35-.42 (.89-1.07)	1.25-1.49 (3.17-3.78)
.90-1.07 (2.29-2.72)	.76-.89 (1.93-2.26)	.65-.77 (1.65-1.96)	.58-.67 (1.47-1.70)	.52-.60 (1.32-1.52)	.46-.54 (1.17-1.37)	.42-.49 (1.07-1.24)	1.50-1.74 (3.81-4.42)
1.07-1.22 (2.72-3.10)	.89-1.02 (2.26-2.59)	.77-.88 (1.96-2.24)	.67-.77 (1.70-1.96)	.60-.69 (1.52-1.75)	.54-.62 (1.37-1.57)	.49-.56 (1.24-1.42)	1.75-1.99 (4.44-5.05)
1.22-1.53 (3.10-3.89)	1.02-1.28 (2.59-3.25)	.88-1.10 (2.24-2.79)	.77-.96 (1.96-2.44)	.69-.86 (1.75-2.18)	.62-.77 (1.57-1.96)	.56-.71 (1.42-1.80)	2.00-2.49 (5.08-6.32)
1.53-1.83 (3.89-4.65)	1.28-1.53 (3.25-3.89)	1.10-1.32 (2.79-3.35)	.96-1.16 (2.44-2.95)	.86-1.03 (2.18-2.62)	.77-.93 (1.96-2.36)	.71-.85 (1.80-2.16)	2.50-2.99 (6.35-7.59)
1.83-2.14 (4.65-5.44)	1.53-1.79 (3.89-4.55)	1.32-1.54 (3.35-3.91)	1.16-1.35 (2.95-3.43)	1.03-1.20 (2.62-3.05)	.93-1.08 (2.36-2.74)	.85-.99 (2.16-2.51)	3.00-3.49 (7.62-8.86)
2.14-2.44 (5.44-6.20)	1.79-2.05 (4.55-5.21)	1.54-1.76 (3.91-4.47)	1.35-1.54 (3.43-3.91)	1.20-1.37 (3.05-3.48)	1.08-1.24 (2.74-3.15)	.99-1.13 (2.51-2.87)	3.50-3.99 (8.89-10.13)
2.44-2.75 (6.20-6.98)	2.05-2.30 (5.21-5.84)	1.76-1.98 (4.47-5.03)	1.54-1.74 (3.91-4.42)	1.37-1.55 (3.48-3.94)	1.24-1.39 (3.15-3.53)	1.13-1.27 (2.87-3.23)	4.00-4.49 (10.16-11.40)
2.75-3.06 (6.98-7.77)	2.30-2.56 (5.84-6.50)	1.98-2.20 (5.03-5.59)	1.74-1.93 (4.42-4.90)	1.55-1.72 (3.94-4.37)	1.39-1.55 (3.53-3.94)	1.27-1.41 (3.23-3.58)	4.50-4.99 (11.43-12.67)

Note: * This chart is not to be used for Conduit Riser Grips. Refer to the chart for Conduit Riser multiple cable section. It is always recommended that, when multiple cables are installed in a pulling grip, the tail end be banded and tightly taped after installation on the cable bundle. See page T-15 for end bands.





Junior Pulling Grip Selection Chart

These charts are a general guide to assist in the selection of the correct Junior Pulling Grip for pulling various groupings of building wire. It is not intended to be restrictive inasmuch as the use of "dummy" wires (short pieces of wire used to fill out the Grip) or the tight taping of the wires into a compact bundle may increase or decrease the number of wires per Grip.

T.H.W.N., T.H.H.N. and X.H.H.W. Building Wire

Desc.	Cable Diameter Range In. (cm)	Approx. Breaking Strength Lbs. (N)	#14	#12	#10	#8	#6	#4	#3	#2	#1	#1/0	Catalog Number
			19 Strand	19 Strand	19 Strand	19 Strand	19 Strand	19 Strand	19 Strand	19 Strand	19 Strand	19 Strand	
J 25	.25-.36 (.63-.91)	450 (2,002)	4-8	3-6	2-3	2	1	1	1	—	—	—	03305001
J 37	.37-.49 (.94-1.24)	900 (4,003)	9-16	6-11	4-6	3	2	—	—	1	1	1	03305002
J 50	.50-.61 (1.27-1.55)	1,300 (5,782)	16-25	11-17	7-10	4-5	3-4	2	2	—	—	—	03305003
J 62	.62-.74 (1.57-1.88)	1,950 (8,674)	26-37	18-25	11-14	6-8	5-6	3	3	2	2	—	03305004
J 75	.75-.99 (1.90-2.51)	2,800 (12,454)	37-66	26-47	15-27	9-16	6-11	4-7	4-5	3-4	3	2-3	03305005
J 100	1.00-1.24 (2.54-3.15)	3,900 (17,347)	66-104	47-74	28-43	16-24	11-17	8-10	6-8	5-7	4-5	4	03305006

R.H.H., R.H., R.W. and R.H.W. Building Wire

Desc.	Cable Diameter Range In. (cm)	Approx. Breaking Strength Lbs. (N)	#14	#12	#10	#8	#6	#4	#2	#1	#1/0	Catalog Number
			7 Strand	7 Strand	7 Strand	7 Strand	7 Strand	7 Strand	7 Strand	7 Strand	19 Strand	
J 25	.25-.36 (.63-.91)	450 (2,002)	2	2	1	1	—	—	—	—	—	03305001
J 37	.37-.49 (.94-1.24)	900 (4,003)	3	2-3	2	—	1	1	1	—	—	03305002
J 50	.50-.61 (1.27-1.55)	1,300 (5,782)	4-5	4-5	3-4	2	—	—	—	1	—	03305003
J 62	.62-.74 (1.57-1.88)	1,950 (8,674)	6-8	6-7	4-5	3	2	2	—	—	1	03305004
J 75	.75-.99 (1.90-2.51)	2,800 (12,454)	9-16	8-14	6-10	4-6	3-4	3-4	2-3	2	—	03305005
J 100	1.00-1.24 (2.54-3.15)	3,900 (17,347)	16-24	15-22	11-16	7-10	5-7	4-6	4	3	2-3	03305006

T.H.W. Building Wire

Desc.	Cable Diameter Range In. (cm)	Approx. Breaking Strength Lbs. (N)	#14	#12	#10	#8	#6	#4	#2	#1	#1/0	Catalog Number
			7 Strand	7 Strand	7 Strand	7 Strand	7 Strand	7 Strand	7 Strand	7 Strand	7 Strand	
J 25	.25-.36 (.63-.91)	450 (2,002)	2-4	2-3	2	1	1	1	—	—	—	03305001
J 37	.37-.49 (.94-1.24)	900 (4,003)	5-7	4-5	3-4	2	—	—	1	—	—	03305002
J 50	.50-.61 (1.27-1.55)	1,300 (5,782)	8-11	6-8	5-7	3-4	2	2	—	1	1	03305003
J 62	.62-.74 (1.57-1.88)	1,950 (8,674)	12-16	9-12	8-10	5-6	3-4	3	2	—	—	03305004
J 75	.75-.99 (1.90-2.51)	2,800 (12,454)	17-30	13-24	11-19	7-10	5-7	4-5	3-4	2	2	03305005
J 100	1.00-1.24 (2.54-3.15)	3,900 (17,347)	31-48	25-37	20-30	11-17	8-11	6-8	5-6	3-4	3	03305006



Kellems® Wire Management Products
Support Grips - Heavy Duty, Standard Duty, Light Duty

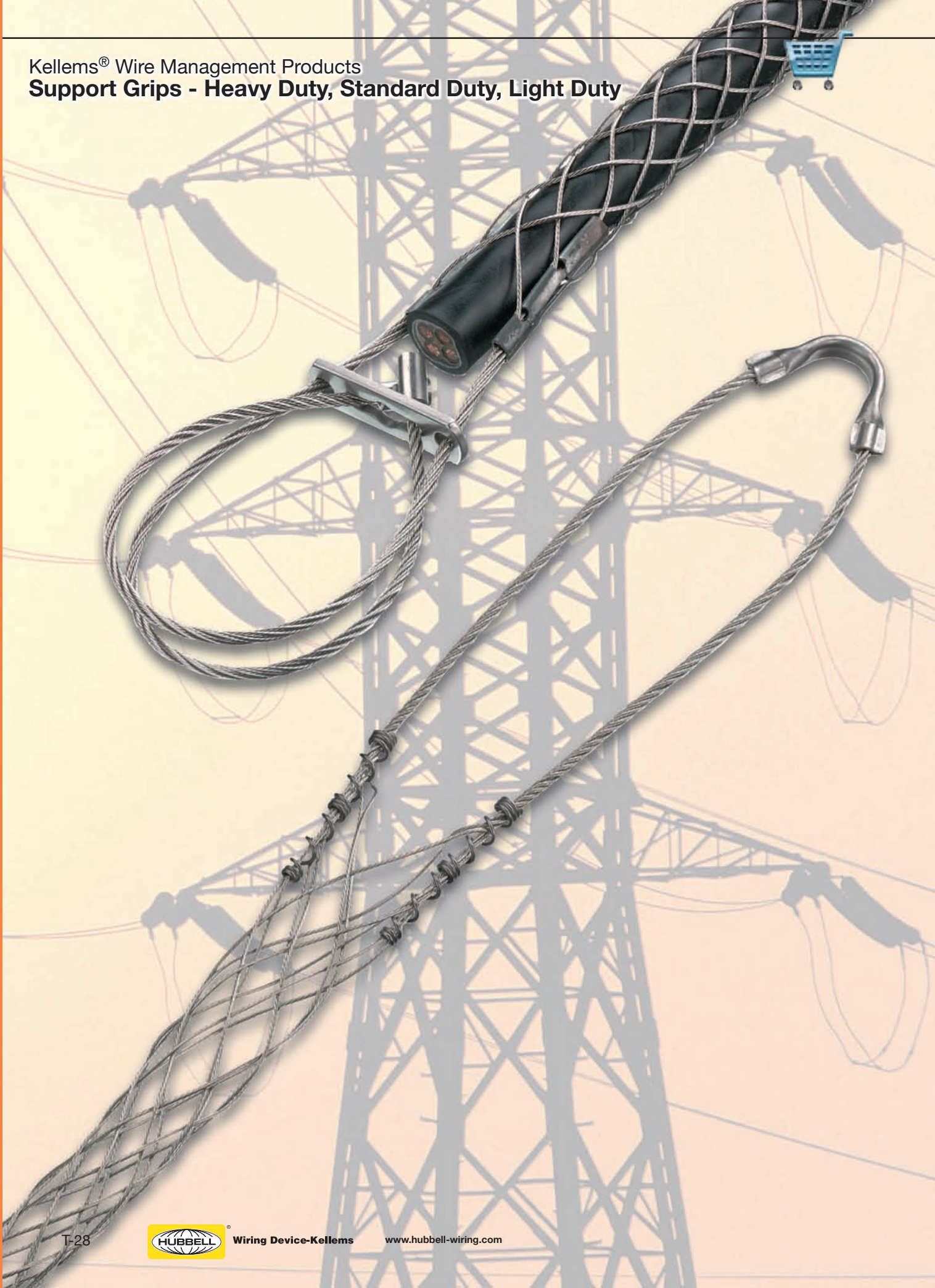

Kellems® Wire Management Products
Support Grips - Heavy Duty, Standard Duty, Light Duty
Tin-Coated Bronze/Stainless Steel



Solid eye assemblies provide eye reinforcement at support hardware

Four eye styles available: single (shown), double, universal, and offset

Identification tag shows: catalog number, diameter range, agency approval, and bar code

The strand equalizer positions wires for equal loading throughout the entire grip length

The positive action mesh grip is designed for light duty up to heavy duty. Closed grips fit over the cable end, split grips wrap around the cable mid-span. The standard material is nonmagnetic, tin-coated bronze. Selected items are available in stainless steel. For exceptional immunity to rust and corrosion with superior strength and flexibility for heavy duty support application in harsh environments; contact the factory

The endless weave provides easy installation onto cable and can be easily repositioned





Kellems® Wire Management Products

Standard Duty Support Grips

Single Eye, Single Weave, Tin-Coated Bronze

WARNING!

It is important that you read all breaking strength, safety and technical data relating to this product on pages T-42 through T-46.



Single Eye, Closed Mesh



Single Eye, Split Mesh, Lace Closing



Single Eye, Split Mesh, Rod Closing

Single Eye, Closed Mesh*

For permanent support when cable end is available to be installed through grip.

Cable Diameter Range Inches (cm)	Approx. Breaking Strength Lbs. (N)	E Inches (cm)	M Inches (cm)	Catalog Number
.50"- .62" (1.27-1.57)	530 (2,357)	7" (17.78)	10" (25.40)	02201013
.63"- .74" (1.60-1.88)	790 (3,514)	8" (20.32)	10" (25.40)	02201014
.75"- .99" (1.90-2.51)	1,020 (4,537)	8" (20.32)	13" (33.02)	02201015
1.00"-1.24" (2.54-3.15)	1,610 (7,161)	9" (22.86)	14" (35.56)	02201017
1.25"-1.49" (3.17-3.78)	1,610 (7,161)	10" (25.40)	15" (38.10)	02201018
1.50"-1.74" (3.81-4.42)	1,610 (7,161)	12" (30.48)	17" (43.18)	02201019
1.75"-1.99" (4.44-5.05)	2,150 (9,563)	14" (35.56)	19" (48.26)	02201020
2.00"-2.49" (5.08-6.32)	3,260 (14,500)	16" (40.64)	21" (53.34)	02201021
2.50"-2.99" (6.35-7.59)	3,260 (14,500)	18" (45.72)	23" (58.42)	02201022
3.00"-3.49" (7.62-8.86)	4,900 (21,795)	21" (53.34)	25" (63.50)	02201023
3.50"-3.99" (8.89-10.13)	4,900 (21,795)	24" (60.96)	27" (68.58)	02201024

Single Eye, Split Mesh, Lace Closing*

For permanent support when cable end is not available.

Cable Diameter Range Inches (cm)	Approx. Breaking Strength Lbs. (N)	E Inches (cm)	M Inches (cm)	Catalog Number
.50"- .62" (1.27-1.57)	530 (2,357)	7" (17.78)	10" (25.40)	02202013
.63"- .74" (1.60-1.88)	790 (3,514)	8" (20.32)	10" (25.40)	02202014
.75"- .99" (1.90-2.51)	1,020 (4,537)	8" (20.32)	13" (33.02)	02202015
1.00"-1.24" (2.54-3.15)	1,610 (7,161)	9" (22.86)	14" (35.56)	02202017
1.25"-1.49" (3.17-3.78)	1,610 (7,161)	10" (25.40)	15" (38.10)	02202018
1.50"-1.74" (3.81-4.42)	1,610 (7,161)	12" (30.48)	17" (43.18)	02202019
1.75"-1.99" (4.44-5.05)	2,150 (9,563)	14" (35.56)	19" (48.26)	02202020
2.00"-2.49" (5.08-6.32)	3,260 (14,500)	16" (40.64)	21" (53.34)	02202021
2.50"-2.99" (6.35-7.59)	3,260 (14,500)	18" (45.72)	23" (58.42)	02202022
3.00"-3.49" (7.62-8.86)	4,900 (21,795)	21" (53.34)	25" (63.50)	02202023
3.50"-3.99" (8.89-10.13)	4,900 (21,795)	24" (60.96)	27" (68.58)	02202024

Single Eye, Split Mesh, Rod Closing*

For support when cable end is not available.

Cable Diameter Range Inches (cm)	Approx. Breaking Strength Lbs. (N)	E Inches (cm)	M Inches (cm)	Catalog Number
.50"- .62" (1.27-1.57)	790 (3,514)	7" (17.78)	8.5" (21.59)	02203013
.63"- .74" (1.60-1.88)	790 (3,514)	8" (20.32)	8.5" (21.59)	02203014
.75"- .99" (1.90-2.51)	1,020 (4,537)	8" (20.32)	10.5" (26.67)	02203015
1.00"-1.24" (2.54-3.15)	1,610 (7,161)	9" (22.86)	12.5" (31.75)	02203017
1.25"-1.49" (3.17-3.78)	1,610 (7,161)	10" (25.40)	14.5" (36.83)	02203018
1.50"-1.74" (3.81-4.42)	1,610 (7,161)	12" (30.48)	15.5" (39.37)	02203019
1.75"-1.99" (4.44-5.05)	2,150 (9,563)	14" (35.56)	16.5" (41.91)	02203020
2.00"-2.49" (5.08-6.32)	3,260 (14,500)	16" (40.64)	19.5" (49.53)	02203021
2.50"-2.99" (6.35-7.59)	3,260 (14,500)	18" (45.72)	21.5" (54.61)	02203022
3.00"-3.49" (7.62-8.86)	5,750 (25,576)	21" (53.34)	23.5" (59.69)	02203023
3.50"-3.99" (8.89-10.13)	5,750 (25,576)	24" (60.96)	25.5" (64.77)	02203024

Note: E-Eye length.

M-Mesh length at nominal diameter.

* Change catalog number from 022 to 024 for stainless steel. Consult factory for availability.

Standard Duty Support Grips

Double Eye, Single Weave, Tin-Coated Bronze



Double Eye, Closed Mesh*

For permanent support when cable end is available to be installed through grip.

Cable Diameter Range Inches (cm)	Approx. Breaking Strength Lbs. (N)	E Inches (cm)	M Inches (cm)	Catalog Number
.50"-.62" (1.27-1.57)	530 (2,357)	4" (10.16)	10" (25.40)	02201001
.63"-.74" (1.60-1.88)	790 (3,514)	4" (10.16)	10" (25.40)	02201002
.75"-.99" (1.90-2.51)	1,020 (4,537)	4" (10.16)	13" (33.02)	02201003
1.00"-1.24" (2.54-3.15)	1,610 (7,161)	5" (12.70)	14" (35.56)	02201005
1.25"-1.49" (3.17-3.78)	1,610 (7,161)	5" (12.70)	15" (38.10)	02201006
1.50"-1.74" (3.81-4.42)	1,610 (7,161)	5" (12.70)	17" (43.18)	02201007
1.75"-1.99" (4.44-5.05)	2,150 (9,563)	6" (15.24)	19" (48.26)	02201008
2.00"-2.49" (5.08-6.32)	3,260 (14,500)	6" (15.24)	21" (53.34)	02201009
2.50"-2.99" (6.35-7.59)	3,260 (14,500)	6" (15.24)	23" (58.42)	02201010
3.00"-3.49" (7.62-8.86)	4,900 (21,795)	8" (20.32)	25" (63.50)	02201011
3.50"-3.99" (8.89-10.13)	4,900 (21,795)	8" (20.32)	27" (68.58)	02201012

Double Eye, Split Mesh, Lace Closing*

For permanent support when cable end is not available.

Cable Diameter Range Inches (cm)	Approx. Breaking Strength Lbs. (N)	E Inches (cm)	M Inches (cm)	Catalog Number
.50"-.62" (1.27-1.57)	530 (2,357)	4" (10.16)	10" (25.40)	02202001
.63"-.74" (1.60-1.88)	790 (3,514)	4" (10.16)	10" (25.40)	02202002
.75"-.99" (1.90-2.51)	1,020 (4,537)	4" (10.16)	13" (33.02)	02202003
1.00"-1.24" (2.54-3.15)	1,610 (7,161)	5" (12.70)	14" (35.56)	02202005
1.25"-1.49" (3.17-3.78)	1,610 (7,161)	5" (12.70)	15" (38.10)	02202006
1.50"-1.74" (3.81-4.42)	1,610 (7,161)	5" (12.70)	17" (43.18)	02202007
1.75"-1.99" (4.44-5.05)	2,150 (9,563)	6" (15.24)	19" (48.26)	02202008
2.00"-2.49" (5.08-6.32)	3,260 (14,500)	6" (15.24)	21" (53.34)	02202009
2.50"-2.99" (6.35-7.59)	3,260 (14,500)	6" (15.24)	23" (58.42)	02202010
3.00"-3.49" (7.62-8.86)	4,900 (21,795)	8" (20.32)	25" (63.50)	02202011
3.50"-3.99" (8.89-10.13)	4,900 (21,795)	8" (20.32)	27" (68.58)	02202012

Double Eye, Split Mesh, Rod Closing*

For support when cable end is not available.

Cable Diameter Range Inches (cm)	Approx. Breaking Strength Lbs. (N)	E Inches (cm)	M Inches (cm)	Catalog Number
.50"-.62" (1.27-1.57)	790 (3,514)	4" (10.16)	8.5" (21.59)	02203001
.63"-.74" (1.60-1.88)	790 (3,514)	4" (10.16)	8.5" (21.59)	02203002
.75"-.99" (1.90-2.51)	1,020 (4,537)	4" (10.16)	10.5" (26.67)	02203003
1.00"-1.24" (2.54-3.15)	1,610 (7,161)	5" (12.70)	12.5" (31.75)	02203005
1.25"-1.49" (3.17-3.78)	1,610 (7,161)	5" (12.70)	14.5" (36.83)	02203006
1.50"-1.74" (3.81-4.42)	1,610 (7,161)	5" (12.70)	15.5" (39.37)	02203007
1.75"-1.99" (4.44-5.05)	2,150 (9,563)	6" (15.24)	16.5" (41.91)	02203008
2.00"-2.49" (5.08-6.32)	3,260 (14,500)	6" (15.24)	19.5" (49.53)	02203009
2.50"-2.99" (6.35-7.59)	3,260 (14,500)	6" (15.24)	21.5" (54.61)	02203010
3.00"-3.49" (7.62-8.86)	5,750 (25,576)	8" (20.32)	23.5" (59.69)	02203011
3.50"-3.99" (8.89-10.13)	5,750 (25,576)	8" (20.32)	25.5" (64.77)	02203012

Note: E-Eye length.

M-Mesh length at nominal diameter.

* Change catalog number from 022 to 024 for stainless steel. Consult factory for availability.

WARNING!

It is important that you read all breaking strength, safety and technical data relating to this product on pages T-42 through T-46.

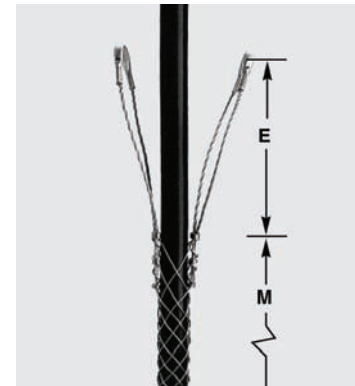

Double Eye, Closed Mesh

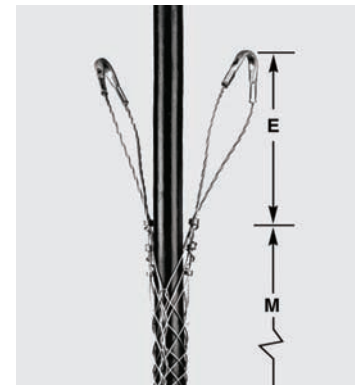

Double Eye, Split Mesh, Lace Closing

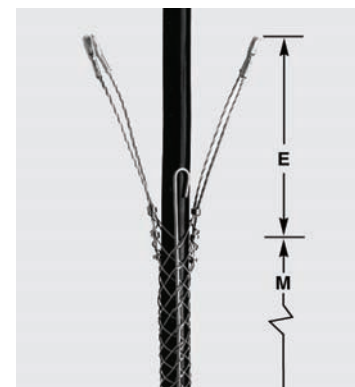

Double Eye, Split Mesh, Rod Closing



Kellems® Wire Management Products

Standard Duty Support Grips

Offset Eye, Single Weave, Tin-Coated Bronze

WARNING!

It is important that you read all breaking strength, safety and technical data relating to this product on pages T-42 through T-46.

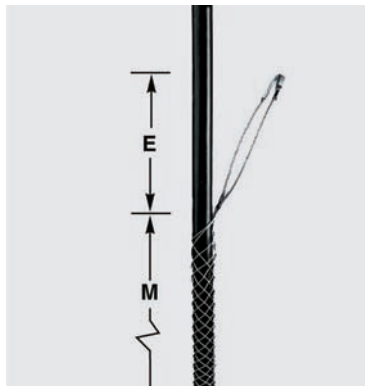

Offset Eye, Closed Mesh

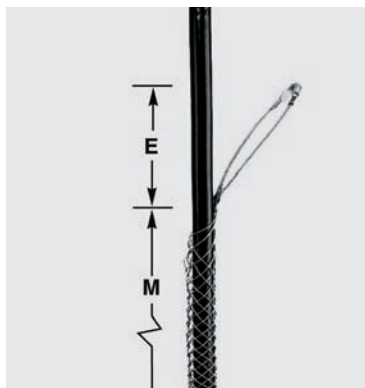

Offset Eye, Split Mesh, Lace Closing

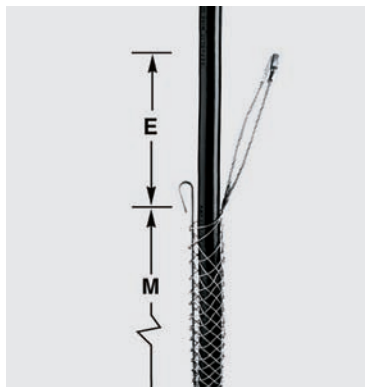

Offset Eye, Split Mesh, Rod Closing

Offset Eye, Closed Mesh*

For permanent support when cable end is available to be installed through grip.

Cable Diameter Range Inches (cm)	Approx. Breaking Strength Lbs. (N)	E Inches (cm)	M Inches (cm)	Catalog Number
.50"--.62" (1.27-1.57)	500 (2,224)	4" (10.16)	10" (25.40)	02201037
.63"--.74" (1.60-1.88)	750 (3,336)	4" (10.16)	10" (25.40)	02201038
.75"--.99" (1.90-2.51)	950 (4,226)	4" (10.16)	13" (33.02)	02201039
1.00"-1.24" (2.54-3.15)	1,500 (6,672)	5" (12.70)	14" (35.56)	02201041
1.25"-1.49" (3.17-3.78)	1,500 (6,672)	5" (12.70)	15" (38.10)	02201042
1.50"-1.74" (3.81-4.42)	1,500 (6,672)	5" (12.70)	17" (43.18)	02201043
1.75"-1.99" (4.44-5.05)	2,000 (8,896)	6" (15.24)	19" (48.26)	02201044
2.00"-2.49" (5.08-6.32)	3,100 (13,789)	9" (22.86)	21" (53.34)	02201045
2.50"-2.99" (6.35-7.59)	3,100 (13,789)	9" (22.86)	23" (58.42)	02201046
3.00"-3.49" (7.62-8.86)	3,800 (16,902)	11" (27.94)	25" (63.50)	02201047
3.50"-3.99" (8.89-10.13)	3,250 (14,480)	11" (27.94)	27" (68.58)	02201048

Offset Eye, Split Mesh, Lace Closing*

For permanent support when cable end is not available.

Cable Diameter Range Inches (cm)	Approx. Breaking Strength Lbs. (N)	E Inches (cm)	M Inches (cm)	Catalog Number
.50"--.62" (1.27-1.57)	500 (2,224)	4" (10.16)	10" (25.40)	02202037
.63"--.74" (1.60-1.88)	750 (3,336)	4" (10.16)	10" (25.40)	02202038
.75"--.99" (1.90-2.51)	950 (4,226)	4" (10.16)	13" (33.02)	02202039
1.00"-1.24" (2.54-3.15)	1,500 (6,672)	5" (12.70)	14" (35.56)	02202041
1.25"-1.49" (3.17-3.78)	1,500 (6,672)	5" (12.70)	15" (38.10)	02202042
1.50"-1.74" (3.81-4.42)	1,500 (6,672)	5" (12.70)	17" (43.18)	02202043
1.75"-1.99" (4.44-5.05)	1,800 (8,006)	6" (15.24)	19" (48.26)	02202044
2.00"-2.49" (5.08-6.32)	2,150 (9,563)	9" (22.86)	21" (53.34)	02202045
2.50"-2.99" (6.35-7.59)	2,150 (9,563)	9" (22.86)	23" (58.42)	02202046
3.00"-3.49" (7.62-8.86)	3,250 (14,480)	11" (27.94)	25" (63.50)	02202047
3.50"-3.99" (8.89-10.13)	3,250 (14,480)	11" (27.94)	27" (68.58)	02202048

Offset Eye, Split Mesh, Rod Closing*

For support when cable end is not available.

Cable Diameter Range Inches (cm)	Approx. Breaking Strength Lbs. (N)	E Inches (cm)	M Inches (cm)	Catalog Number
.50"--.62" (1.27-1.57)	500 (2,224)	4" (10.16)	7" (17.78)	02203037
.63"--.74" (1.60-1.88)	750 (3,336)	4" (10.16)	9" (22.86)	02203038
.75"--.99" (1.90-2.51)	950 (4,226)	4" (10.16)	10" (25.40)	02203039
1.00"-1.24" (2.54-3.15)	1,500 (6,672)	5" (12.70)	12" (30.48)	02203041
1.25"-1.49" (3.17-3.78)	1,500 (6,672)	5" (12.70)	14" (35.56)	02203042
1.50"-1.74" (3.81-4.42)	1,500 (6,672)	5" (12.70)	15" (38.10)	02203043
1.75"-1.99" (4.44-5.05)	2,000 (8,896)	6" (15.24)	16" (40.64)	02203044
2.00"-2.49" (5.08-6.32)	3,100 (13,789)	9" (22.86)	19" (48.26)	02203045
2.50"-2.99" (6.35-7.59)	3,100 (13,789)	9" (22.86)	20" (50.80)	02203046
3.00"-3.49" (7.62-8.86)	4,300 (19,126)	11" (27.94)	21" (53.34)	02203047
3.50"-3.99" (8.89-10.13)	4,900 (21,795)	11" (27.94)	21" (53.34)	02203048

Note: E-Eye length.

M-Mesh length at nominal diameter.

* Change catalog number from 022 to 024 for stainless steel. Consult factory for availability.

Standard Duty Support Grips

Universal Eye, Single Weave, Tin-Coated Bronze



Universal Eye, Closed Mesh*

For permanent support when cable end is available to be installed through grip.

Cable Diameter Range Inches (cm)	Approx. Breaking Strength Lbs. (N)	E Inches (cm)	M Inches (cm)	Catalog Number
.50"-.62" (1.27-1.57)	530 (2,357)	18" (45.72)	10" (25.40)	02201051
.63"-.74" (1.60-1.88)	790 (3,514)	18" (45.72)	10" (25.40)	02201052
.75"-.99" (1.90-2.51)	1,020 (4,537)	18" (45.72)	13" (33.02)	02201053
1.00"-1.24" (2.54-3.15)	1,610 (7,161)	18" (45.72)	14" (35.56)	02201050
1.25"-1.49" (3.17-3.78)	1,610 (7,161)	18" (45.72)	15" (38.10)	02201054
1.50"-1.74" (3.81-4.42)	1,610 (7,161)	18" (45.72)	17" (43.18)	02201055
1.75"-1.99" (4.44-5.05)	2,150 (9,563)	18" (45.72)	19" (48.26)	02201056
2.00"-2.49" (5.08-6.32)	3,260 (14,500)	18" (45.72)	21" (53.34)	02201057
2.50"-2.99" (6.35-7.59)	3,260 (14,500)	18" (45.72)	23" (58.42)	02201058

Universal Eye, Split Mesh, Lace Closing

For permanent support when cable end is not available.

Cable Diameter Range Inches (cm)	Approx. Breaking Strength Lbs. (N)	E Inches (cm)	M Inches (cm)	Catalog Number
.50"-.62" (1.27-1.57)	530 (2,357)	18" (45.72)	10" (25.40)	02202050
.63"-.74" (1.60-1.88)	790 (3,514)	18" (45.72)	10" (25.40)	02202051
.75"-.99" (1.90-2.51)	1,020 (4,537)	18" (45.72)	13" (33.02)	02202052
1.00"-1.24" (2.54-3.15)	1,610 (7,161)	18" (45.72)	14" (35.56)	02202054
1.25"-1.49" (3.17-3.78)	1,610 (7,161)	18" (45.72)	15" (38.10)	02202055
1.50"-1.74" (3.81-4.42)	1,610 (7,161)	18" (45.72)	17" (43.18)	02202056
1.75"-1.99" (4.44-5.05)	2,150 (9,563)	18" (45.72)	19" (48.26)	02202057
2.00"-2.49" (5.08-6.32)	3,260 (14,500)	18" (45.72)	21" (53.34)	02202058
2.50"-2.99" (6.35-7.59)	3,260 (14,500)	18" (45.72)	23" (58.42)	02202059
3.50"-3.99" (8.89-10.13)	4,900 (21,795)	18" (45.72)	27" (68.58)	02202061

Universal Eye, Split Mesh, Rod Closing*

For support when cable end is not available.

Cable Diameter Range Inches (cm)	Approx. Breaking Strength Lbs. (N)	E Inches (cm)	M Inches (cm)	Catalog Number
.50"-.62" (1.27-1.57)	790 (3,514)	18" (45.72)	8.5" (21.59)	02203064
.63"-.74" (1.60-1.88)	790 (3,514)	18" (45.72)	8.5" (21.59)	02203065
.75"-.99" (1.90-2.51)	1,020 (4,537)	18" (45.72)	10.5" (26.67)	02203066
1.00"-1.24" (2.54-3.15)	1,610 (7,161)	18" (45.72)	12.5" (31.75)	02203068
1.25"-1.49" (3.17-3.78)	1,610 (7,161)	18" (45.72)	14.5" (36.83)	02203069
1.50"-1.74" (3.81-4.42)	1,610 (7,161)	18" (45.72)	15.5" (39.37)	02203070
1.75"-1.99" (4.44-5.05)	2,150 (9,563)	18" (45.72)	16.5" (41.91)	02203071
2.00"-2.49" (5.08-6.32)	3,260 (14,500)	18" (45.72)	19.5" (49.53)	02203072
2.50"-2.99" (6.35-7.59)	3,260 (14,500)	18" (45.72)	21.5" (54.61)	02203073
3.00"-3.49" (7.62-8.86)	5,750 (25,576)	18" (45.72)	23.5" (59.69)	02203074

Note: E-Eye length.

M-Mesh length at nominal diameter.

* Change catalog number from 022 to 024 for stainless steel. Consult factory for availability.

WARNING!

It is important that you read all breaking strength, safety and technical data relating to this product on pages T-42 through T-46.

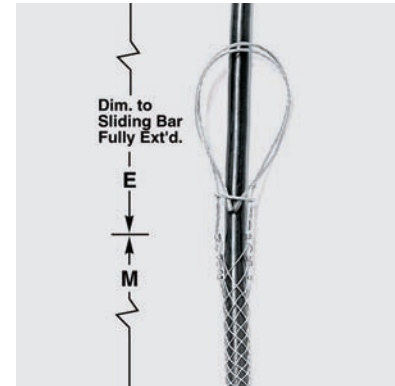

Universal Eye, Closed Mesh

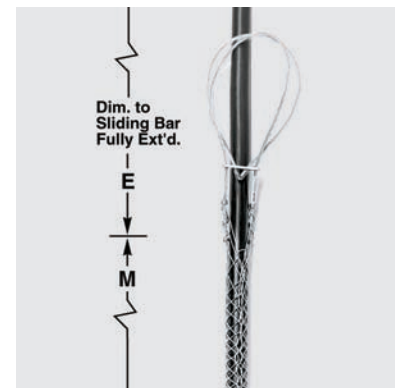

Universal Eye, Split Mesh, Lace Closing

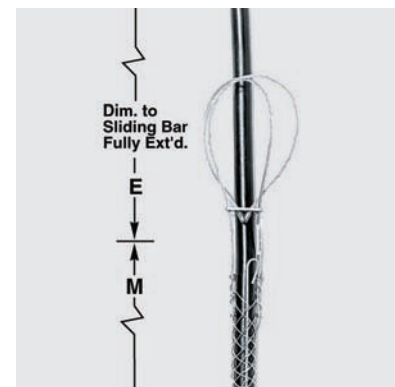

Universal Eye, Split Mesh, Rod Closing



Kellems® Wire Management Products

Heavy Duty Support Grips

Single Eye, Double Weave, Tin-Coated Bronze

WARNING!

It is important that you read all breaking strength, safety and technical data relating to this product on pages T-42 through T-46.

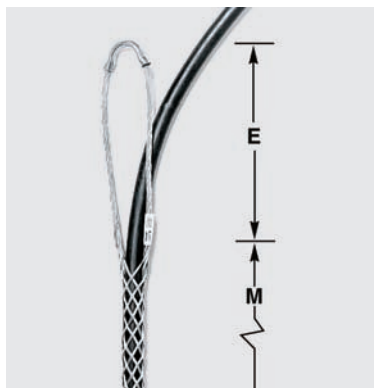

Heavy Duty, Single Eye, Closed Mesh

Heavy Duty, Single Eye, Closed Mesh*

For heavy duty permanent support when cable end is available to be installed through grip.

Cable Diameter Range Inches (cm)	Approx. Breaking Strength Lbs. (N)	E Inches (cm)	M Inches (cm)	Catalog Number
.75"- .99" (1.90-2.51)	2,820 (12,543)	10" (25.40)	25" (63.50)	02206010
1.00"-1.24" (2.54-3.15)	4,280 (19,037)	12" (30.48)	28" (71.12)	02206011
1.25"-1.49" (3.17-3.78)	4,280 (19,037)	12" (30.48)	30" (76.20)	02206012
1.50"-1.99" (3.81-5.05)	4,280 (19,037)	12" (30.48)	34" (86.36)	02206013

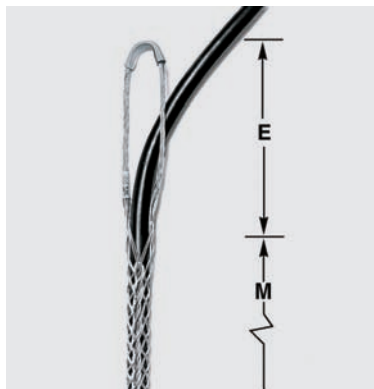

Single Eye, Split Mesh, Lace Closing

Single Eye, Split Mesh, Lace Closing*

For permanent support when cable end is not available to be installed through grip.

Cable Diameter Range Inches (cm)	Approx. Breaking Strength Lbs. (N)	E Inches (cm)	M Inches (cm)	Catalog Number
.75"- .99" (1.90-2.51)	2,820 (12,543)	10" (25.40)	25" (63.50)	02207010
1.00"-1.24" (2.54-3.15)	4,280 (19,037)	12" (30.48)	28" (71.12)	02207011
1.25"-1.49" (3.17-3.78)	4,280 (19,037)	12" (30.48)	30" (76.20)	02207012
1.50"-1.99" (3.81-5.05)	4,280 (19,037)	12" (30.48)	34" (86.36)	02207013

Note: E-Eye length.

M-Mesh length at nominal diameter.

* Change catalog number from 022 to 024 for stainless steel. Consult factory for availability.



Kellems® Wire Management Products

Heavy Duty Support Grips

Double Eye, Double Weave, Tin-Coated Bronze

WARNING!

It is important that you read all breaking strength, safety and technical data relating to this product on pages T-42 through T-46.

Double Eye, Closed Mesh*

For permanent support when cable end is available to be installed through grip.

Cable Diameter Range Inches (cm)	Approx. Breaking Strength Lbs. (N)	E Inches (cm)	M Inches (cm)	Catalog Number
.75"-.99" (1.90-2.51)	2,820 (12,543)	10" (25.40)	25" (63.50)	02206001
1.00"-1.24" (2.54-3.15)	4,280 (19,037)	10" (25.40)	28" (71.12)	02206002
1.25"-1.49" (3.17-3.78)	4,280 (19,037)	10" (25.40)	30" (76.20)	02206003
1.50"-1.99" (3.81-5.05)	4,280 (19,037)	10" (25.40)	34" (86.36)	02206004
2.00"-2.49" (5.08-6.32)	8,050 (35,806)	12" (30.48)	36" (91.44)	02206005
2.50"-2.99" (6.35-7.59)	8,050 (35,806)	12" (30.48)	38" (96.52)	02206006
3.00"-3.49" (7.62-8.86)	10,060 (44,747)	12" (30.48)	40" (101.60)	02206007
3.50"-3.99" (8.89-10.13)	12,070 (53,687)	12" (30.48)	44" (111.76)	02206008
4.00"-4.49" (10.16-11.40)	12,070 (53,687)	12" (30.48)	46" (116.84)	02206009
4.50"-4.99" (11.43-12.67)	12,070 (53,687)	12" (30.48)	68" (172.72)	02208009

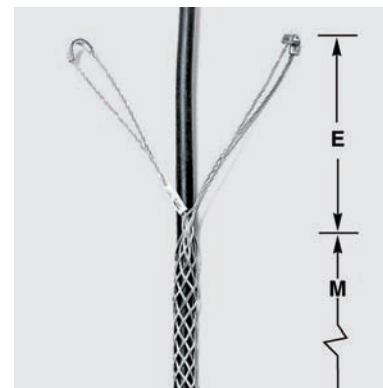

Double Eye, Closed Mesh

Double Eye, Split Mesh, Lace Closing*

For support when cable end is not available.

Cable Diameter Range Inches (cm)	Approx. Breaking Strength Lbs. (N)	E Inches (cm)	M Inches (cm)	Catalog Number
.75"-.99" (1.90-2.51)	2,820 (12,543)	10" (25.40)	25" (63.50)	02207001
1.00"-1.24" (2.54-3.15)	4,280 (19,037)	10" (25.40)	28" (71.12)	02207002
1.25"-1.49" (3.17-3.78)	4,280 (19,037)	10" (25.40)	30" (76.20)	02207003
1.50"-1.99" (3.81-5.05)	4,280 (19,037)	10" (25.40)	34" (86.36)	02207004
2.00"-2.49" (5.08-6.32)	8,050 (35,806)	12" (30.48)	36" (91.44)	02207005
2.50"-2.99" (6.35-7.59)	8,050 (35,806)	12" (30.48)	38" (96.52)	02207006
3.00"-3.49" (7.62-8.86)	10,060 (44,747)	12" (30.48)	40" (101.60)	02207007
3.50"-3.99" (8.89-10.13)	12,070 (53,687)	12" (30.48)	44" (111.76)	02207008
4.00"-4.49" (10.16-11.40)	12,070 (53,687)	12" (30.48)	46" (116.84)	02207009
4.50"-4.99" (11.43-12.67)	12,070 (53,687)	12" (30.48)	68" (172.72)	02209009



Double Eye, Split Mesh, Lace Closing

Note: E-Eye length.

M-Mesh length at nominal diameter.

* Change catalog number from 022 to 024 for stainless steel. Consult factory for availability.



Kellems® Wire Management Products

Service Drop Grips

Single Eye, Tin-Coated Bronze

WARNING!

It is important that you read all breaking strength, safety and technical data relating to this product on pages T-42 through T-46.



Light Duty, Single Eye, Closed Mesh, Single Weave



Heavy Duty, Single Eye, Closed Mesh, Multi-Weave

Light Duty, Single Eye, Closed Mesh, Single Weave

For permanent support when cable end is available to be installed.

Cable Diameter Range Inches (cm)	Approx. Breaking Strength Lbs. (N)	E Inches (cm)	M Inches (cm)	Catalog Number
.23"-.31" (.58-.79)	290 (1,290)	3" (7.62)	3.75" (9.52)	02216001
.29"-.37" (.74-.94)	290 (1,290)	5" (12.70)	4.25" (10.79)	02216002
.35"-.44" (.89-1.12)	500 (2,224)	5.5" (13.97)	4.75" (12.06)	02216003
.41"-.50" (1.04-1.27)	500 (2,224)	5.5" (13.97)	5" (12.70)	02216004
.46"-.56" (1.17-1.42)	660 (2,936)	6" (15.24)	5.25" (13.33)	02216005
.52"-.62" (1.32-1.57)	790 (3,514)	7" (17.78)	6.25" (15.87)	02216006
.58"-.68" (1.47-1.73)	790 (3,514)	7" (17.78)	6½" (16.51)	02216007
.64"-.75" (1.63-1.90)	790 (3,514)	7" (17.78)	6.75" (17.14)	02216008
.70"-.81" (1.78-2.06)	790 (3,514)	7" (17.78)	7.25" (18.41)	02216009
.75"-.87" (1.90-2.21)	1,020 (4,537)	8" (20.32)	8" (20.32)	02216010
.81"-.94" (2.06-2.39)	1,020 (4,537)	8" (20.32)	8.25" (20.95)	02216011
.87"-1.00" (2.21-2.54)	1,020 (4,537)	8" (20.32)	8.75" (22.22)	02216012
.94"-1.06" (2.39-2.69)	1,020 (4,537)	9" (22.86)	9" (22.86)	02216013
1.00"-1.18" (2.54-3.00)	1,020 (4,537)	9" (22.86)	9.5" (24.13)	02216014
1.06"-1.25" (2.69-3.17)	1,020 (4,537)	9" (22.86)	9.5" (24.13)	02216015

Heavy Duty, Single Eye, Closed Mesh, Multi-Weave

For permanent support when cable end is available to be installed.

Cable Diameter Range Inches (cm)	Approx. Breaking Strength Lbs. (N)	E Inches (cm)	M Inches (cm)	Catalog Number
.23"-.31" (.58-.79)	500 (2,224)	5" (12.70)	4.5" (11.43)	02217001
.29"-.37" (.74-.94)	500 (2,224)	5" (12.70)	5.5" (13.97)	02217002
.35"-.44" (.89-1.12)	870 (3,870)	6" (15.24)	6.5" (16.51)	02217003
.41"-.50" (1.04-1.27)	870 (3,870)	6" (15.24)	7.5" (19.05)	02217004
.46"-.56" (1.17-1.42)	1,050 (4,670)	6" (15.24)	8" (20.32)	02217005
.52"-.62" (1.32-1.57)	1,050 (4,670)	7" (17.78)	8.5" (21.59)	02217006
.58"-.68" (1.47-1.73)	1,050 (4,670)	7" (17.78)	9.5" (24.13)	02217007
.64"-.75" (1.63-1.90)	1,390 (6,183)	7" (17.78)	9.5" (24.13)	02217008
.70"-.81" (1.78-2.06)	1,390 (6,183)	8" (20.32)	10.5" (26.67)	02217009
.75"-.87" (1.90-2.21)	1,390 (6,183)	8" (20.32)	10.5" (26.67)	02217010
.81"-.94" (2.06-2.39)	1,390 (6,183)	8" (20.32)	10.5" (26.67)	02217011
.87"-1.00" (2.21-2.54)	1,790 (7,962)	8" (20.32)	11.5" (29.21)	02217012
.94"-1.06" (2.39-2.69)	1,790 (7,962)	9" (22.86)	12.5" (31.75)	02217013
1.00"-1.18" (2.54-3.00)	1,790 (7,962)	9" (22.86)	13.5" (34.29)	02217014
1.06"-1.25" (2.69-3.17)	1,790 (7,962)	9" (22.86)	14.5" (36.83)	02217015

Note: E-Eye length.

M-Mesh length at nominal diameter.

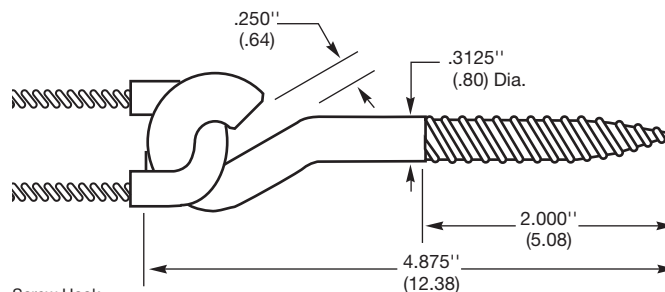

Screw Hook
Catalog Number 20303001
Yield Strength 900 lbs (4003 N)

Service Drop Grips

Universal Eye, Tin-Coated Bronze



Light Duty, Universal Eye, Closed Mesh, Single Weave

For permanent support when cable end is available to be installed.

Cable Diameter Range Inches (cm)	Approx. Breaking Strength Lbs. (N)	E Inches (cm)	M Inches (cm)	Catalog Number
.23"-.31" (.58-.79)	290 (1,290)	9" (22.86)	3.75" (9.52)	02216016
.29"-.37" (.74-.94)	290 (1,290)	10" (25.40)	4.25" (10.79)	02216017
.35"-.44" (.89-1.12)	500 (2,224)	10" (25.40)	4.75" (12.06)	02216018
.41"-.50" (1.04-1.27)	500 (2,224)	11" (27.94)	5" (12.70)	02216019
.46"-.56" (1.17-1.42)	660 (2,936)	12" (30.48)	5.25" (13.33)	02216020
.52"-.62" (1.32-1.57)	790 (3,514)	13" (33.02)	6.25" (15.87)	02216021
.58"-.68" (1.47-1.73)	790 (3,514)	13" (33.02)	6.5" (16.51)	02216022
.64"-.75" (1.63-1.90)	790 (3,514)	13" (33.02)	6.75" (17.14)	02216023
.70"-.81" (1.78-2.06)	790 (3,514)	13" (33.02)	7.25" (18.41)	02216024
.75"-.87" (1.90-2.21)	1,020 (4,537)	14" (35.56)	8" (20.32)	02216025
.81"-.94" (2.06-2.39)	1,020 (4,537)	14" (35.56)	8.25" (20.95)	02216026
.87"-1.00" (2.21-2.54)	1,020 (4,537)	14" (35.56)	8.75" (22.22)	02216027
.94"-1.06" (2.39-2.69)	1,020 (4,537)	15" (38.10)	9" (22.86)	02216028
1.00"-1.18" (2.54-3.00)	1,020 (4,537)	15" (38.10)	9.5" (24.13)	02216029
1.06"-1.25" (2.69-3.17)	1,020 (4,537)	15" (38.10)	9.5" (24.13)	02216030

WARNING!

It is important that you read all breaking strength, safety and technical data relating to this product on pages T-42 through T-46.

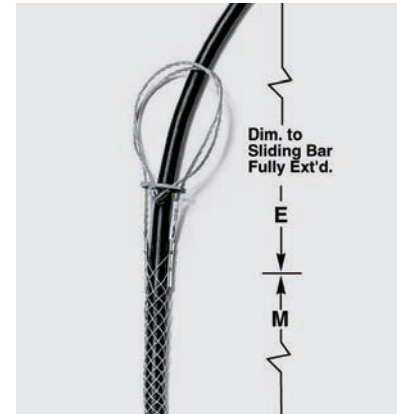

Light Duty, Universal Eye, Closed Mesh, Single Weave

Heavy Duty, Universal Eye, Closed Mesh, Multi-Weave

For permanent support when cable end is available to be installed.

Cable Diameter Range Inches (cm)	Approx. Breaking Strength Lbs. (N)	E Inches (cm)	M Inches (cm)	Catalog Number
.23"-.31" (.58-.79)	500 (2,224)	11" (27.94)	4.5" (11.43)	02217016
.28"-.37" (.74-.94)	500 (2,224)	11" (27.94)	5.5" (13.97)	02217017
.35"-.44" (.89-1.12)	870 (3,870)	12" (30.48)	6.5" (16.51)	02217018
.41"-.50" (1.04-1.27)	870 (3,870)	12" (30.48)	7.5" (19.05)	02217019
.46"-.56" (1.17-1.42)	1,050 (4,670)	12" (30.48)	8" (20.32)	02217020
.52"-.62" (1.32-1.57)	1,050 (4,670)	13" (33.02)	8.5" (21.59)	02217021
.58"-.68" (1.47-1.73)	1,050 (4,670)	13" (33.02)	9.5" (24.13)	02217022
.64"-.75" (1.63-1.90)	1,390 (6,183)	13" (33.02)	9.5" (24.13)	02217023
.70"-.81" (1.78-2.06)	1,390 (6,183)	14" (35.56)	10.5" (26.67)	02217024
.75"-.87" (1.90-2.21)	1,390 (6,183)	14" (35.56)	10.5" (26.67)	02217025
.81"-.94" (2.06-2.39)	1,390 (6,183)	14" (35.56)	10.5" (26.67)	02217026
.87"-1.00" (2.21-2.54)	1,790 (7,962)	14" (35.56)	11.5" (29.21)	02217027
.94"-1.06" (2.39-2.69)	1,790 (7,962)	15" (38.10)	12.5" (31.75)	02217028
1.00"-1.18" (2.54-3.00)	1,790 (7,962)	15" (38.10)	13.5" (34.29)	02217029
1.06"-1.25" (2.69-3.17)	1,790 (7,962)	15" (38.10)	14.5" (36.83)	02217030



Heavy Duty, Universal Eye, Closed Mesh, Multi-Weave

Note: E-Eye length.

M-Mesh length at nominal diameter.



Kellems® Wire Management Products

Bus Drop Support Grips

Single Eye, Universal Eye, Galvanized Steel

WARNING!

It is important that you read all breaking strength, safety and technical data relating to this product on pages T-42 through T-46.

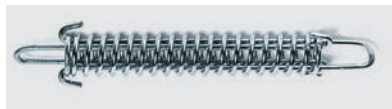

Safety Spring

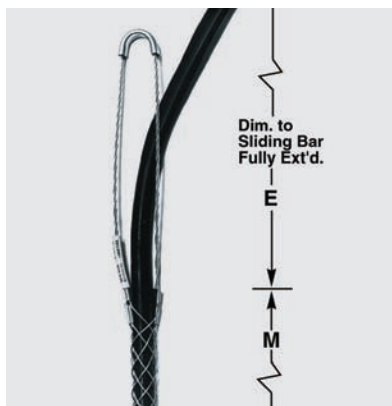

Single Eye, Wide Range

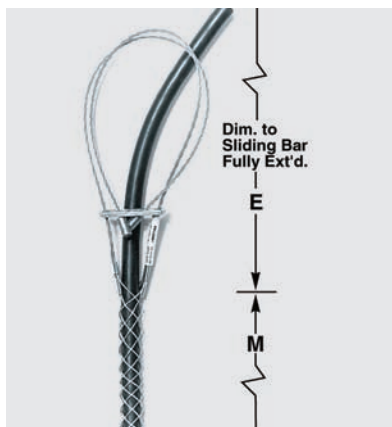

Universal Eye, Wide Range

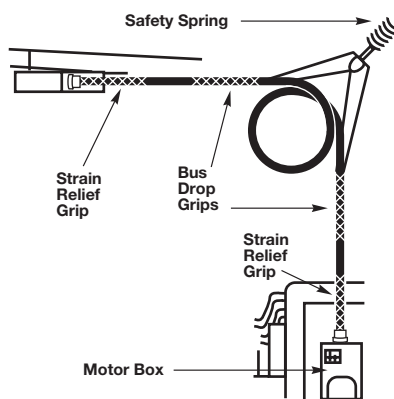

Safety Spring

Maximum Deflection Inches/Lbs (cm/N)	Approx. Breaking Strength Lbs. (N)	Length* Inches (cm)	Diameter Inches (cm)	Model Lbs. (N)	Catalog Number
2¾" at 40 lbs. (6.98 cm at 178 N)	500 (2,224)	8.25" (20.95)	.75" (1.90)	40 lb. spring (178)	20302001
3" at 80 lbs. (7.94 cm at 356 N)	850 (3,781)	8.25" (20.95)	1" (2.54)	80 lb. spring (356)	20302002

Note: Springs can be used with single eye grips by disassembling drawbar from coil, placing through eye and replacing drawbar.

* No load.

Single Eye, Wide Range

Cable Diameter Range Inches (cm)	Approx. Breaking Strength Lbs. (N)	E Inches (cm)	M Inches (cm)	Catalog Number
.24"-.32" (.61-.81)	350 (1,557)	3" (7.62)	3.5" (8.89)	073041276**
.32"-.43" (.81-1.09)	450 (2,002)	4" (10.16)	4" (10.16)	073041277
.43"-.56" (1.09-1.42)	550 (2,446)	6" (15.24)	4.75" (12.06)	073041278
.56"-.73" (1.42-1.85)	1,000 (4,448)	7" (17.78)	6" (15.24)	073041279
.73"-.85" (1.85-2.16)	1,400 (6,227)	7" (17.78)	6.75" (17.14)	073041280
.85"-1.00" (2.16-2.54)	1,400 (6,227)	8" (20.32)	8" (20.32)	073041281
1.00"-1.25" (2.54-3.17)	1,500 (6,672)	9" (22.86)	9.5" (24.13)	073041282

Universal Eye, Wide Range

Cable Diameter Range Inches (cm)	Approx. Breaking Strength Lbs. (N)	E Inches (cm)	M Inches (cm)	Catalog Number
.32"-.43" (.81-1.09)	450 (2,002)	10" (25.40)	4" (10.16)	073041284
.43"-.56" (1.09-1.42)	550 (2,446)	12" (30.48)	4.75" (12.06)	073041285
.56"-.73" (1.42-1.85)	1,000 (4,448)	13" (33.02)	6" (15.24)	073041286
.73"-.85" (1.85-2.16)	1,400 (6,227)	13" (33.02)	6.75" (17.14)	073041287
.85"-1.00" (2.16-2.54)	1,400 (6,227)	14" (35.56)	8" (20.32)	073041288
1.00"-1.25" (2.54-3.17)	1,500 (6,672)	15" (38.10)	9.5" (24.13)	073041289

Note: E-Eye length.

M-Mesh length at nominal diameter.

** Item indicated is not UL listed.

Bus Drop Grips and Safety Springs

Kellems Bus Drop Grips are offered with either a single eye or universal bale attachment. The mesh is single weave galvanized steel with the patented wide range construction. They are suitable for indoor use only. Consult Technical Service for Stainless Steel Grips.

Application

Bus Drop Grips provide a safe, easy and economical method to support flexible cord or bus drop cable at bus duct and other industrial areas.

Benefits

- Easily installed.
- Absorb tension, vibration and pull with no cable damage.
- Patented mesh construction.

Safety Spring

Springs can be used with single eye grips by disassembling drawbar from coil, placing through eye and replacing drawbar.



Wire Management Products

Conduit Riser Grips

Ring Type, Single Weave, Tin-Coated Bronze

WARNING!

It is important that you read all breaking strength, safety and technical data relating to this product on pages T-47 and T-48.

Single Weave, Closed Mesh

Kellems® Conduit Riser Support Grips are available in closed mesh and in split mesh with lace or rod closures, to cover all applications including single cable or multiple wire support. Refer to technical section, T-47 for grip selection assistance for cable bundles. The standard material is tin-coated bronze strand. The grip is permanently fastened to a support ring, resulting in a one piece unit which will allow air ventilation within the conduit. The ring will fit standard electrical rigid metal conduit and schedule 40 rigid PVC conduit only. See page T-48 for ring dimensions. For permanent support when cable end is available to be installed through the grip.



Suitable For Standard Electrical Rigid Metal Conduit and Schedule 40 Rigid PVC Conduit Only

Cable Sizes Inches (cm)	.50" – .62" (1.27–1.57)	.63" – .74" (1.60–1.88)	.75" – .99" (1.90–2.51)	1.00" – 1.24" (2.54–3.15)	1.25" – 1.49" (3.17–3.78)	1.50" – 1.74" (3.81–4.42)	1.75" – 1.99" (4.44–5.05)	2.00" – 2.49" (5.08–6.32)	2.50" – 2.99" (6.35–7.59)	3.00" – 3.49" (7.62–8.86)	3.50" – 3.99" (8.89–10.13)
Model	R050	R062	R075	R100	R125	R150	R175	R200	R250	R300	R350
Length											
Inches (cm)	8" (20.32)	9" (22.86)	11" (27.94)	12" (30.48)	12" (30.48)	14" (35.56)	15" (38.10)	17" (43.18)	18" (45.72)	20" (50.80)	21" (53.34)
Conduit Sizes	Catalog Number										
Inches	Approx. Breaking Strength Lbs. (N)										
¾	02211106 530 (2,357)	–	–	–	–	–	–	–	–	–	–
1	02211100 490 (2,179)	02211101 790 (3,514)	–	–	–	–	–	–	–	–	–
1¼	02211001 450 (2,002)	02211002 740 (3,292)	02211003 1,030 (4,581)	–	–	–	–	–	–	–	–
1½	–	02211006 690 (3,069)	02211007 970 (4,315)	02211009 1,610 (7,161)	–	–	–	–	–	–	–
2	–	02211107 640 (2,847)	02211010 920 (4,092)	02211012 1,520 (6,761)	02211013 1,610 (7,161)	–	–	–	–	–	–
2½	–	–	–	–	02211017 1,510 (6,716)	02211018 1,610 (7,161)	02211019 2,150 (9,563)	–	–	–	–
3	–	–	–	02211022 1,340 (5,960)	02211023 1,400 (6,227)	02211024 1,490 (6,627)	02211025 1,990 (8,851)	02211026 3,260 (14,500)	–	–	–
3½	–	–	–	–	–	–	–	02211033 2,970 (13,211)	02211034 3,260 (14,500)	–	–
4	–	–	–	–	–	–	02211040 1,670 (7,248)	02211041 2,680 (11,921)	02211042 2,890 (12,855)	02211043 4,080 (18,148)	–
5	–	–	–	–	–	–	–	–	02211061 2,150 (9,563)	02211062 2,860 (12,721)	02211063 3,130 (13,922)
6	–	–	–	–	–	–	–	–	–	02211072 2,245 (9,986)	02211073 2,245 (9,986)

Note: See page T-47 for multiple cables in a single conduit riser grip.



Kellems® Wire Management Products

Conduit Riser Grips

Ring Type, Double Weave, Tin-Coated Bronze



WARNING!

It is important that you read all breaking strength, safety and technical data relating to this product on pages T-47 and T-48.

Double Weave, Split Mesh, Lace Closing

Kellems® Conduit Riser Support Grips will support cable runs in vertical or sloping standard rigid conduit. The grip is fastened to a support ring which seats on the rim of the conduit. The entire grip is supported by the conduit itself and no other hardware is required. See page T-48 for ring dimensions. The rings will fit schedule 40 rigid PVC conduit and standard electrical rigid metal conduit only. For permanent support when cable end is not available.

Suitable For Standard Electrical Rigid Metal Conduit and Schedule 40 Rigid PVC Conduit Only

Cable Sizes Inches (cm)	.75"-.99" (1.90-2.51)	1.00"-1.24" (2.54-3.15)	1.25"-1.49" (3.17-3.78)	1.50"-1.74" (3.81-4.42)	1.75"-1.99" (4.44-5.05)	2.00"-2.49" (5.08-6.32)	2.50"-2.99" (6.35-7.59)	3.00"-3.49" (7.62-8.86)	3.50"-3.99" (8.89-10.13)	
Model	RS075	RS100	RS125	RS150	RS175	RS200	RS250	RS300	RS350	
Length Inches (cm)	11" (27.94)	12" (30.48)	12" (30.48)	14" (35.56)	15" (38.10)	17" (43.18)	18" (45.72)	20" (50.80)	21" (53.34)	
Conduit Sizes Inches	Catalog Number Approx. Breaking Strength Lbs. (N)									
1¼	02212003 1,580 (7,028)									
1½	02212007 1,500 (6,672)									
2	02212010 1,430 (6,361)		02212012 1,930 (8,585)		02212013 2,040 (9,074)		-			
2½	-		02212017 1,910 (8,496)		02212018 2,040 (9,074)		-			
3	-		02212023 1,780 (7,917)		02212024 1,890 (8,407)		02212025 2,520 (11,209)		02212026 4,300 (19,126)	
3½	-		-		-		02212033 3,910 (17,392)		02212034 4,300 (19,126)	
4	-		-		02212040 2,110 (9,385)		02212041 3,530 (15,701)		02212042 3,820 (16,991)	
5	-		-		-		02212061 2,860 (12,721)		-	
6	-		-		-		-		02212073 2,955 (13,144)	

Note: See page T-47 for multiple cables in a single conduit riser grip.

Conduit Riser Grips

Ring Type, Single Weave, Tin-Coated Bronze



WARNING!

It is important that you read all breaking strength, safety and technical data relating to this product on pages T-47 and T-48.

Single Weave, Split Mesh, Rod Closing Benefits

- Easy and fast to install.
- Will not damage electrical cable.
- Allows cable to expand or contract.
- Ideal way to hold cable in vertical conduit.
- Prevents cable creep in conduit.
- Helps prevent cable pullouts.
- The rings will fit schedule 40 rigid PVC conduit and standard electrical rigid metal conduit only.
- For support when cable end is not available.

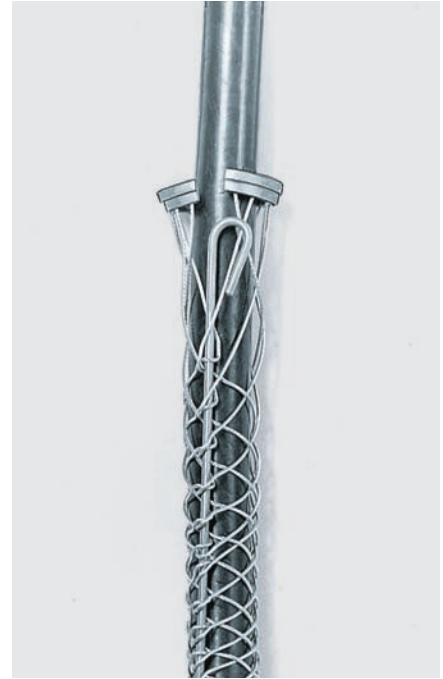

Suitable For Standard Electrical Rigid Metal Conduit and Schedule 40 Rigid PVC Conduit Only

Cable Sizes Inches (cm)	.75" - .99" (1.90-2.51)	1.00" - 1.24" (2.54-3.15)	1.25" - 1.49" (3.17-3.78)	1.50" - 1.74" (3.81-4.42)	1.75" - 1.99" (4.44-5.05)	2.00" - 2.49" (5.08-6.32)	2.50" - 2.99" (6.35-7.59)	3.00" - 3.49" (7.62-8.86)	3.50" - 3.99" (8.89-10.13)
Model	RR075	RR100	RR125	RR150	RR175	RR200	RR250	RR300	RR350
Length Inches (cm)	11" (27.94)	12" (30.48)	13" (33.02)	14" (35.56)	15" (38.10)	16" (40.64)	18" (45.72)	19" (48.26)	21" (53.34)
Conduit Sizes Inches	Catalog Number Approx. Breaking Strength Lbs. (N)								
1¼	02213003 1,020 (4,537)	—	—	—	—	—	—	—	—
1½	02213007 970 (4,315)	02213009 1,610 (7,161)	—	—	—	—	—	—	—
2	—	02213012 1,520 (6,761)	02213013 1,610 (7,161)	—	—	—	—	—	—
2½	—	—	02213017 1,510 (6,716)	02213018 1,610 (7,161)	—	—	—	—	—
3	—	—	02213023 1,400 (6,227)	02213024 1,490 (6,627)	02213025 1,990 (8,851)	02213026 3,260 (14,500)	—	—	—
3½	—	—	—	—	—	02213033 2,970 (13,211)	—	—	—
4	—	—	—	—	—	02213041 2,670 (11,876)	02213042 2,890 (12,855)	—	—

Note: See page T-47 for multiple cables in a single conduit riser grip.





Kellems® Wire Management Products

Technical Information

Support Grips

Kellems Support Grips

Kellems Support Grips are used to hold the weight of electrical cable as it hangs in a vertical, sloping or horizontal position. Electrical cable must be supported, or its dead weight can cause excessive strain or pullout at the connections resulting in power failure. Support grips also absorb additional strain from flexure, vibration, expansion and contraction. Kellems Support Grips listed in this catalog are made of high grade, non-magnetic tin-coated bronze strand. Stainless steel grips, made of alloy 302-304 SST for severe service or unusual environmental conditions, are available on request.

Select the Correct Support Grip

Each Kellems grip is designed to work on a specific range of cable diameters.

- Step 1** Refer to the Kellems chart below to determine the grip style best suited for your application.
- Step 2** Determine your cable outside diameter.
- Step 3** Find the grip size that encompasses your cable diameter.
- Step 4** Whenever possible, use a closed mesh that assembles over the cable end. If the cable end is not available, use a split mesh.
- Step 5** Where available, select an eye style that suits your needs.
- Step 6** Select the proper material—tinned bronze or stainless steel*.
- Step 7** Estimate the tension to be put on the grip, establish the working load you require and compare this to the listed approximate breaking strength of the grip to insure that the grip will be strong enough. Refer to page T-43 for safety and working load considerations.

CAUTION: It is very important to comply with all of the following precautions.

1. Support grips are to be installed by a qualified individual in accordance with all applicable national and local safety, electrical and rigging codes.
2. Ensure that the correct grip is selected for your specific needs.
3. Do not use a support grip for any application other than supporting cable.
4. Thoroughly examine the grip for damage. Do not use a damaged grip.
5. Ensure that the recommended work load of the grip is suitable for the application. Never use grips at their approximated rated breaking strength. A safety factor of 10 is recommended for support grips.
6. Do not alter grips in any way. For example, do not flatten, straighten, bend or otherwise modify eye tubes, hooks, and strand equalizers.
7. Do not attach any type of hook, clamp or other hardware directly to the stranded bale of a “U” eye support grip. The formed eye tube is the only acceptable means of attachment to external hardware.
8. Always apply 2 bands at 1" and 2" respectively, from the tail end of the mesh to guard against accidental release of the grip. Accidental release can occur if an object contracts and pushes against the tail end of the mesh, thereby expanding and releasing it's hold.

Support Grip Selection Chart

Grip Styles	Application	Page
Closed mesh	Standard, permanent support, cable end available.	T-30 to T-38
Split lace closing	Standard, permanent support, cable end unavailable.	T-30 to T-35
Split rod closing	Standard, temporary support, cable end unavailable. Tape or band tail end of wire mesh grip after positioning for permanent support.	T-30 to T-33
Material*	Tin-coated bronze standard or stainless steel by special request.	T-30 to T-41
Standard support grips	Support vertical runs to 99 ft. loads to 600 lbs.	T-30 to T-33
Heavy duty grips	Support vertical runs over 100 ft. loads over 600 lbs.	T-34, T-35
Service drop	Light duty to support service entrance cable.	T-36, T-37
Bus drop	Light duty support, indoors only, on Bus drop cable.	T-38
Conduit riser	Support cable runs in rigid (Schedule 40) conduit.	T-39 to T-41
Fiber optic cable support grips	Support fiber optic cable.	T-53

Note: * Most catalog listed support grips are made of tin-coated bronze strand. To order stainless steel support grips, change the first three catalog number digits from 022-0x-xxx to 024-0x-xxx. Consult Technical Service for details.

Eye Styles



Single

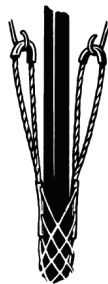

Double



Universal



Offset



Kellems® Wire Management Products

Technical Information

Support Grips

Safety And Working Load Factors For Wire Mesh Grips

The broad application of Kellems grips on a wide variety of objects requires that adequate safety factors be used to establish working loads. The approximate breaking strength of a Kellems grip represents an average calculation based on data established from actual direct tension testing done in our engineering laboratories.

It is impossible to catalog or guarantee a safety factor suitable for all applications as operating conditions are never the same. The tension, diameter, movement, number of objects gripped, gripping surface, and the attachments used are just some of the factors which vary with each application. These factors, together with the effects of abrasion, corrosion, prior use or abuse and any other variables of a specific application, must be considered by the user and the grip replaced as

appropriate. Where the conditions of the application are not well defined or known, or where risk of injury to persons or property is involved, a greater safety factor should be utilized.

Under normal conditions, Kellems' recommended factor of safety is five for catalog listed pulling grips, and ten for catalog listed support grips.

Any warranty as to quality, performance or fitness for use of grips is always premised on the condition that the published breaking strengths apply only to new, unused grips, and that such products are properly stored, handled, used, maintained, and inspected by the user at a frequency appropriate for the use and condition of the grip.

Examples

Grip Style	Approx. Breaking Strength Lbs. (N)	Safety Factor	Max. Rec. Load Lbs. (N)	Catalog Number
Pulling Grips	27,200 (120,986)	5	5,440 (24,197)	03301027
Support Grips	1,610 (7,161)	10	161 (716)	02202019

The maximum recommended working load is the tension to be exerted on the grip in application with a margin of safety to take care of unforeseen and unusual circumstances.

It is the end-user's decision to determine how much of a safety factor is acceptable for the application.

The metric unit of measure (force) for breaking strength and load is newtons (N). To convert from newtons to the metric unit of weight (kilograms) the conversion factor is 9.808 newtons/kilogram.

Support Grip Materials

Material	Features	Grip Type
Tin-coated bronze wire	<ul style="list-style-type: none"> • Corrosion resistant for normal outside areas • Non-magnetic • Moderate strength 	<ul style="list-style-type: none"> • Support grips • Service drop grips • Conduit riser grips
Stainless steel wire (302-304)	<ul style="list-style-type: none"> • High strength • Corrosion resistant 	<ul style="list-style-type: none"> • Support grips • Hose containment grips
Galvanized steel wire	<ul style="list-style-type: none"> • Slightly magnetic • Not subject to continuous outside environment 	<ul style="list-style-type: none"> • Bus drop grips

Approvals

CSA Certifications are indicated on appropriate product catalog pages.

Note: It is always recommended that the tail end of the grip be banded after the installation on the cable to prevent accidental release of the mesh. See page T-15 for end bands.



Kellems® Wire Management Products

Technical Information

Support Grips

Split Support Grip Lace Closing Instructions

Single Weave Grips should be laced with single strand lacing; double weave with double strand. Lacing strands should be the same material as the grip. Kellems supplies the appropriate lacing with each grip.

1. Start the lacing at the lead or anchoring end of the grip. Thread the lacings through the first two loops of the split and pull through until the lacings are centered at this point. Lace as you would your shoe, crossing the lacings before lacing the next two loops.
2. Don't pull lacing too tight. Leave a space between adjoining loops approximately equal to the width of one diamond of the mesh.
3. Twist the lacing strands tightly together at the tail end of the grip.
4. Wrap the ends of the lacings once or twice tightly around the tail of the grip, twisting the ends together securely. Excess lace can be cut off.

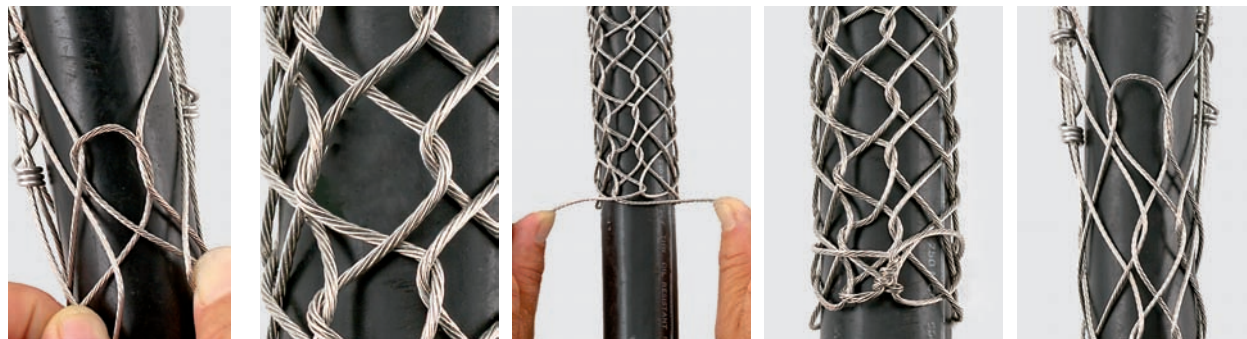

Split Support Grip Rod Closing Instructions

The stainless steel rod is a precise built-in feature which makes threading easy and fast. The strands of the mesh pass around the rod and match up with the strands from the opposite direction. The rod does not touch the cable at any point and therefore cannot cut the cable. Rod Closing Grips are reusable. They may be removed and reused as many times as desired.

1. **Fast to install**
Wrap the grip around the cable and thread the rod through the pre-formed loops with a corkscrew motion, using the curved end of the rod to engage the loops.
2. The action required is a steady push and twist simultaneously. The fingers of the left hand are used to bring the loops together just ahead of the hook on the end of the rod.
3. To remove, simply pull the rod out.



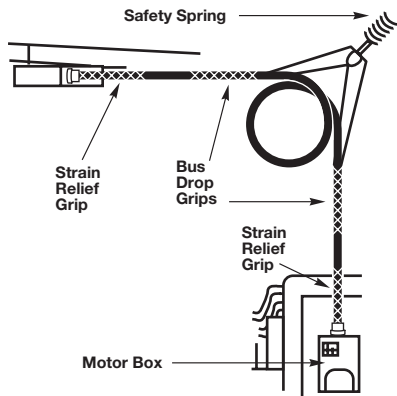

Bus Drop Grips and Safety Springs

Kellems Bus Drop Grips are offered with either a single eye or universal bale attachment. The mesh is single weave galvanized steel with the patented wide range construction. They are suitable for indoor use only.

Application

Bus Drop Grips provide a safe, easy and economical method to support flexible cord or bus drop cable at bus duct and other industrial areas.

Benefits

- Easily installed.
- Absorb tension, vibration and pull with no cable damage.
- Patented mesh construction.

Safety Spring

Springs can be used with single eye grips by disassembling drawbar from coil, placing through eye and replacing drawbar.



Kellems® Wire Management Products

Technical Information

Support Grips

For Support Grips Only*

Multiple Cable Selection Charts for Cables and Wires of Unequal Diameters

How to choose the correct grip size:

1. Find the Grip Circumference Range by measuring the circumference of the bundle of different diameter cables to be gripped (see illustration).
2. Divide the bundle circumference by 3.14 to determine the diameter.
3. Choose a grip offering a range of cable diameters the same as the cable diameter.

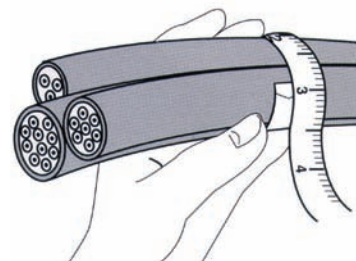

For Cables of Equal Diameters

Under "Number of Cables in One Grip", find the diameter of your single cable in vertical column. Read the grip diameter range to the right. If your diameter is the maximum of the range shown, go to the next larger size for Split Grips, stay with the same size for Closed Grips.

Example: 3 cables, each with .89" (2.26cm) diameter, for a Closed Grip select the 1.50"-1.74" (3.81cm-4.42cm) range, for a Split Grip select the 1.75"-1.99" (4.44cm-5.05cm) range.

Number of Cables in One Grip

2	3	4	5	6 and 7	8	9	Grip Dia. Range Inches (cm)
.30-.38 (.76-.97)	.25-.31 (.63-.79)	.22-.27 (.56-.69)	.19-.24 (.48-.61)	.17-.22 (.43-.56)	.15-.19 (.38-.48)	.14-.18 (.36-.46)	.50-.61 (1.27-1.55)
.38-.44 (.97-1.12)	.31-.36 (.79-.91)	.27-.31 (.69-.79)	.24-.29 (.61-.74)	.22-.26 (.56-.66)	.19-.23 (.48-.58)	.18-.21 (.46-.53)	.62-.74 (1.57-1.88)
.44-.59 (1.12-1.50)	.36-.49 (.91-1.24)	.31-.42 (.79-1.07)	.29-.38 (.74-.97)	.26-.34 (.66-.86)	.23-.31 (.58-.79)	.21-.28 (.53-.71)	.75-.99 (1.90-2.51)
.59-.75 (1.50-1.90)	.49-.63 (1.24-1.60)	.42-.54 (1.07-1.37)	.38-.48 (.97-1.22)	.34-.43 (.86-1.09)	.31-.39 (.79-.99)	.28-.35 (.71-.89)	1.00-1.24 (2.54-3.15)
.75-.90 (1.90-2.29)	.63-.76 (1.60-1.93)	.54-.65 (1.37-1.65)	.48-.58 (1.22-1.47)	.43-.52 (1.09-1.32)	.39-.46 (.99-1.17)	.35-.42 (.89-1.07)	1.25-1.49 (3.17-3.78)
.90-1.07 (2.29-2.72)	.76-.89 (1.93-2.26)	.65-.77 (1.65-1.96)	.58-.67 (1.47-1.70)	.52-.60 (1.32-1.52)	.46-.54 (1.17-1.37)	.42-.49 (1.07-1.24)	1.50-1.74 (3.81-4.42)
1.07-1.22 (2.72-3.10)	.89-1.02 (2.26-2.59)	.77-.88 (1.96-2.24)	.67-.77 (1.70-1.96)	.60-.69 (1.52-1.75)	.54-.62 (1.37-1.57)	.49-.56 (1.24-1.42)	1.75-1.99 (4.44-5.05)
1.22-1.53 (3.10-3.89)	1.02-1.28 (2.59-3.25)	.88-1.10 (2.24-2.79)	.77-.96 (1.96-2.44)	.69-.86 (1.75-2.18)	.62-.77 (1.57-1.96)	.56-.71 (1.42-1.80)	2.00-2.49 (5.08-6.32)
1.53-1.83 (3.89-4.65)	1.28-1.53 (3.25-3.89)	1.10-1.32 (2.79-3.35)	.96-1.16 (2.44-2.95)	.86-1.03 (2.18-2.62)	.77-.93 (1.96-2.36)	.71-.85 (1.80-2.16)	2.50-2.99 (6.35-7.59)
1.83-2.14 (4.65-5.44)	1.53-1.79 (3.89-4.55)	1.32-1.54 (3.35-3.91)	1.16-1.35 (2.95-3.43)	1.03-1.20 (2.62-3.05)	.93-1.08 (2.36-2.74)	.85-.99 (2.16-2.51)	3.00-3.49 (7.62-8.86)
2.14-2.44 (5.44-6.20)	1.79-2.05 (4.55-5.21)	1.54-1.76 (3.91-4.47)	1.35-1.54 (3.43-3.91)	1.20-1.37 (3.05-3.48)	1.08-1.24 (2.74-3.15)	.99-1.13 (2.51-2.87)	3.50-3.99 (8.89-10.13)
2.44-2.75 (6.20-6.98)	2.05-2.30 (5.21-5.84)	1.76-1.98 (4.47-5.03)	1.54-1.74 (3.91-4.42)	1.37-1.55 (3.48-3.94)	1.24-1.39 (3.15-3.53)	1.13-1.27 (2.87-3.23)	4.00-4.49 (10.16-11.40)
2.75-3.06 (6.98-7.77)	2.30-2.56 (5.84-6.50)	1.98-2.20 (5.03-5.59)	1.74-1.93 (4.42-4.90)	1.55-1.72 (3.94-4.37)	1.39-1.55 (3.53-3.94)	1.27-1.41 (3.23-3.58)	4.50-4.99 (11.43-12.67)

Note: * This chart is to be used for determining grip size when multiple cables are held in a single Support Grip. For Conduit Riser multiple cable selection, see page T-47. It is always recommended that, when multiple cables are installed in a Support Grip, the tail end of the grip be banded after installation on the cable bundle.



For Conduit Riser Grips Only*

Multiple Cable Selection Charts for Cables and Wires of Unequal Diameters

How to choose the correct grip size:

1. Find the Grip Circumference Range by measuring the circumference of the bundle of different diameter cables to be gripped (see illustration).
2. Divide the bundle circumference by 3.14 to determine the diameter.
3. Choose a grip offering a range of cable diameters the same as the cable diameter.

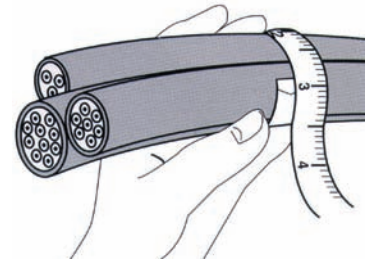

For Cables of Equal Diameters

Under "Number of Cables in One Grip", find the diameter of your single cable in vertical column. Read the grip diameter range to the right. If your diameter is the maximum of the range shown, go to the next larger size for Split Grips, stay with the same size for Closed Grips.

Example: 3 cables, each with .85" (2.16cm) diameter, for a Closed Grip select the 1.50"-1.74" (3.81cm-4.42cm) range, for a Split Grip select the 1.75"-1.99" (4.44cm-5.05cm) range.

Number of Equal Diameter Cables in One Grip

2	3	4	5	6 and 7	8	9	Grip Dia. Range Inches (cm)
.29-.36 (.74-.91)	.24-.30 (.61-.76)	.21-.25 (.53-.63)	.18-.22 (.46-.56)	.16-.20 (.41-.51)	.15-.18 (.38-.46)	.14-.17 (.36-.43)	.50-.62 (1.27-1.57)
.37-.43 (.94-1.09)	.31-.36 (.79-.91)	.26-.30 (.66-.76)	.23-.27 (.58-.69)	.21-.24 (.53-.61)	.19-.22 (.48-.56)	.18-.20 (.46-.51)	.63-.74 (1.60-1.88)
.44-.58 (1.12-1.47)	.37-.48 (.94-1.22)	.31-.41 (.79-1.04)	.28-.36 (.71-.91)	.25-.32 (.63-.81)	.23-.29 (.58-.74)	.21-.27 (.53-.69)	.75-.99 (1.90-2.51)
.59-.72 (1.50-1.83)	.49-.60 (1.24-1.52)	.42-.51 (1.07-1.30)	.37-.45 (.94-1.14)	.33-.40 (.84-1.02)	.30-.36 (.76-.91)	.28-.34 (.71-.86)	1.00-1.24 (2.54-3.15)
.73-.87 (1.85-2.21)	.61-.72 (1.55-1.83)	.52-.61 (1.32-1.55)	.46-.54 (1.17-1.37)	.41-.48 (1.04-1.22)	.37-.43 (.94-1.09)	.35-.40 (.89-1.02)	1.25-1.49 (3.17-3.78)
.88-1.01 (2.24-2.57)	.73-.85 (1.85-2.16)	.62-.71 (1.57-1.80)	.55-.63 (1.40-1.60)	.49-.56 (1.24-1.42)	.44-.51 (1.12-1.30)	.41-.47 (1.04-1.19)	1.50-1.74 (3.81-4.42)
1.02-1.16 (2.59-2.95)	.86-.96 (2.18-2.44)	.72-.81 (1.83-2.06)	.64-.72 (1.63-1.83)	.57-.64 (1.45-1.63)	.52-.58 (1.32-1.49)	.48-.54 (1.22-1.37)	1.75-1.99 (4.44-5.05)
1.17-1.44 (2.97-3.66)	.97-1.20 (2.46-3.05)	.82-1.02 (2.08-2.59)	.73-.90 (1.85-2.29)	.65-.80 (1.65-2.03)	.59-.72 (1.50-1.83)	.55-.67 (1.40-1.70)	2.00-2.49 (5.08-6.32)
1.45-1.73 (3.68-4.39)	1.21-1.45 (3.07-3.68)	1.03-1.22 (2.62-3.10)	.91-1.08 (2.31-2.74)	.81-.96 (2.06-2.44)	.73-.87 (1.85-2.21)	.68-.81 (1.73-2.06)	2.50-2.99 (6.35-7.59)
1.74-2.02 (4.42-5.13)	1.46-1.69 (3.71-4.29)	1.23-1.43 (3.12-3.63)	1.09-1.26 (2.77-3.20)	.97-1.11 (2.46-2.82)	.83-1.01 (2.11-2.57)	.82-.94 (2.08-2.39)	3.00-3.49 (7.62-8.86)
2.03-2.31 (5.16-5.87)	1.70-1.93 (4.32-4.90)	1.44-1.63 (3.66-4.14)	1.27-1.44 (3.23-3.66)	1.12-1.27 (2.84-3.23)	1.02-1.15 (2.59-2.92)	.95-1.08 (2.41-2.74)	3.50-3.99 (8.89-10.13)

Note: * This chart is to be used for determining grip size when multiple cables are held in a single Conduit Riser Grip. For Support Grip multiple cable selection, see page T-46. It is always recommended that, when multiple cables are installed in a Conduit Riser Grip, the tail end of the grip be banded after installation on the cable bundle.



Kellems® Wire Management Products

Conduit Riser Grips

Conduit Riser Support Grip-Ring Dimensions

WARNING!

It is important that you read all breaking strength, safety and technical data relating to this product on pages T-41 through T-48.

Conduit Ring Dimensions

Ring dimensions are found in the chart below. The ring material is corrosion resistant. These rings will fit schedule 40 rigid PVC conduit and standard electrical rigid metal conduit only.

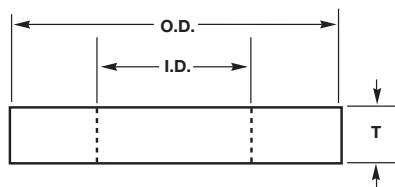

Conduit Size 3/4" and 1"

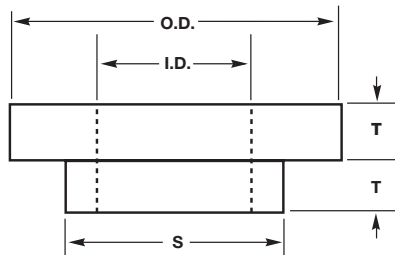

Conduit Size 1 1/4" to 6"

Conduit Size Inches	Ring Number	O.D. Inches (cm)	I.D. Inches (cm)	S Inches (cm)	T Inches (cm)
3/4	C-3/4	.94" (2.39)	.62" (1.57)	—	.19" (.48)
1	C-1	1.17" (2.97)	.80" (2.03)	—	.19" (.48)
1 1/4	C-1 1/4	1.50" (3.81)	1.03" (2.62)	1.31" (3.33)	.16" (.41)
1 1/2	C-1 1/2	1.76" (4.47)	1.23" (3.12)	1.52" (3.86)	.16" (.41)
2	C-2	2.23" (5.66)	1.55" (3.94)	1.97" (5.00)	.16" (.41)
2 1/2	C-2 1/2	2.67" (6.78)	2.05" (5.21)	2.40" (6.10)	.16" (.41)
3	C-3	3.20" (8.13)	2.55" (6.48)	2.97" (7.54)	.22" (.56)
3 1/2	C-3 1/2	3.80" (9.65)	3.05" (7.75)	3.47" (8.81)	.22" (.56)
4	C-4	4.30" (10.92)	3.55" (9.02)	3.94" (10.01)	.22" (.56)
4 1/2	C-4 1/2	4.80" (12.19)	4.03" (10.24)	4.45" (11.30)	.22" (.56)
5	C-5	5.30" (13.46)	4.46" (11.33)	4.96" (12.60)	.22" (.56)
6	C-6	6.30" (16.00)	5.36" (13.61)	5.96" (15.14)	.25" (.63)

Fiber Optic Cable Grips

Pulling and Support Grips



OPTISOK® Grip is a revolutionary tool to pull preterminated fiber optic cables. They will protect the connectors and guide the bundle through the pulling environment



Pulling Grips are used for outside plant cable. They are easy to install and remove, reusable, and have a slim profile for small build up

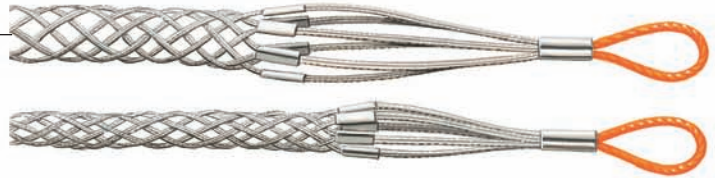

Grips for cable support are easy to install or position. They come in a closed style when the cable end is available, and a split rod style for mid-span installation. Will support the cable's weight as it hangs in vertical, sloping or horizontal position





Kellems® Wire Management Products

Fiber Optic Cable Pulling Grips

Special Purpose

WARNING!

It is important that you read all breaking strength, safety and technical data relating to this product on pages T-54 through T-57.

OPTISOK® Non-metallic Fiber Optic Pulling Tool For Preterminated, Inside Plant Fiber Optic Cables and Bundles of Twisted Pair



Patented

OPTISOK® Non-Metallic Fiber Optic Pulling Tool

Bundle/Size Range Inches (cm)	Approx. O/A Length Inches (cm)	Ring O.D. Inches (cm)	Ring Thickness Inches (cm)	Maximum Work Load lbs. (N)	Catalog Number
.125"-.562" (.318-1.427)	28" (71.12)	.71" (1.803)	.10" (.254)	30 (133)	CCPS1
.250"-.750" (.635-1.905)	31" (78.74)	.71" (1.803)	.10" (.254)	40 (178)	CCPS2
.750"-1.750" (1.905-4.445)	33" (83.82)	1.57" (3.988)	.16" (.406)	50 (222)	CCPS3

Pulling Grip For Loose Tube Fiber Optic Cable, Galvanized Steel

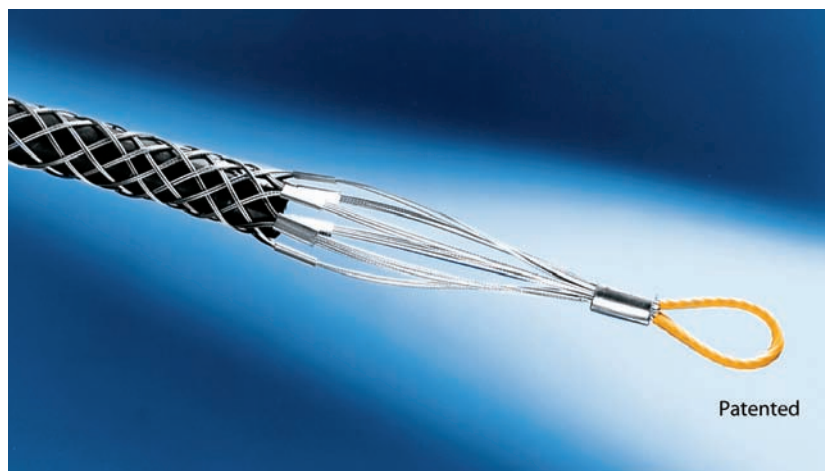

Patented

Pulling Grip For Loose Tube Fiber Optic Cable, Galvanized Steel

Diameter Range Inches (cm)	Mesh Length Inches (cm)	Eye Length Inches (cm)	Eye Diameter Inches (cm)	Lug Diameter Inches (cm)	Maximum Breaking Strength lbs. (N)	Catalog Number
.312"-.625" (.79-1.59)	22.5" (57.15)	6.3" (16.00)	.20" (.51)	.51" (1.30)	3,000 (13,344)	PFOLT312





Kellems® Wire Management Products
Fiber Optic Cable Pulling Grips
 Double/Single Weave Mesh, Galvanized Steel, for Outside Plant Cable

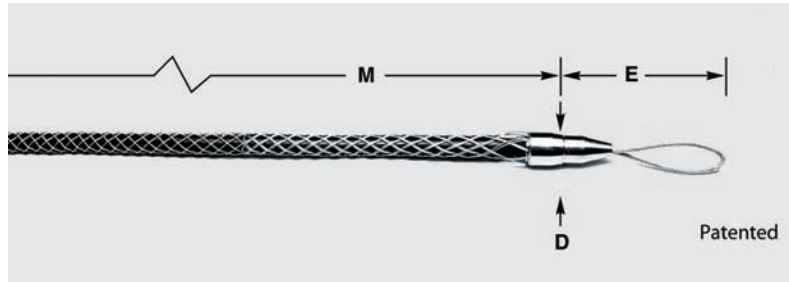

WARNING!
 It is important that you read all breaking strength, safety and technical data relating to this product on pages T-54 through T-57.

F-O Pulling Grip, Flexible Eye

Cable Diameter Range Inches (cm)	Approx. Breaking Strength Lbs. (N)	E Approx. Inches (cm)	M Approx. Inches (cm)	D Approx. Inches (cm)	Catalog Number
.10"-.22" (.25-.56)	1,000 (4,448)	5.5" (14)	9" (23)	0.8" (2)	033291000
.21"-.35" (.53-.89)	1,500 (6,672)	5.5" (14)	14" (36)	0.8" (2)	033291001
.32"-.48" (.81-1.22)	2,200 (9,786)	6.0" (15)	18" (46)	0.9" (2.29)	033291002
.42"-.61" (1.07-1.55)	2,800 (12,454)	6.0" (15)	21" (53)	0.9" (2.29)	033291003
.53"-.74" (1.35-1.88)	3,300 (14,678)	6.5" (17)	24" (61)	1.3" (3.30)	033291004
.64"-.87" (1.63-2.21)	4,700 (20,906)	6.5" (17)	27" (69)	1.3" (3.30)	033291005

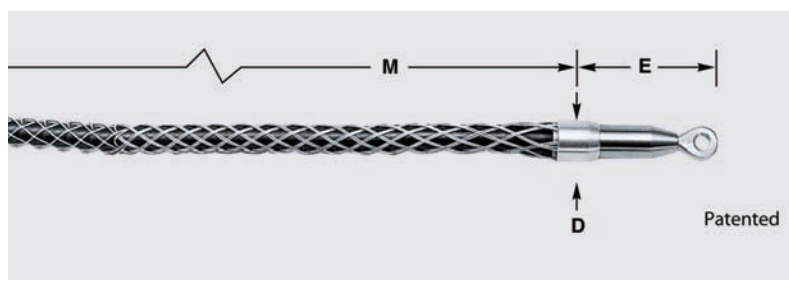

F-O Pulling Grip, Swivel Eye

Cable Diameter Range Inches (cm)	Approx. Breaking Strength Lbs. (N)	E Approx. Inches (cm)	M Approx. Inches (cm)	D Approx. Inches (cm)	Catalog Number
.21"-.35" (.53-.89)	1,500 (6,672)	4.0" (10.16)	14" (35.56)	0.9" (2.29)	033291008
.32"-.48" (.81-1.22)	2,200 (9,786)	4.0" (10.16)	18" (45.72)	0.9" (2.29)	033291009
.42"-.61" (1.07-1.55)	2,800 (12,454)	4.0" (10.16)	21" (53.34)	0.9" (2.29)	033291010
.53"-.74" (1.35-1.88)	3,300 (14,678)	4.5" (11.43)	24" (60.96)	1.3" (3.30)	033291011
.64"-.87" (1.63-2.21)	4,700 (20,906)	4.5" (11.43)	27" (68.58)	1.3" (3.30)	033291012

Note: E-Eye length.
 M-Mesh length at nominal diameter.





Kellems® Wire Management Products

Fiber Optic Cable Pulling Grips

Galvanized Steel for Outside Plant Cable

WARNING!

It is important that you read all breaking strength, safety and technical data relating to this product on pages T-54 through T-57.

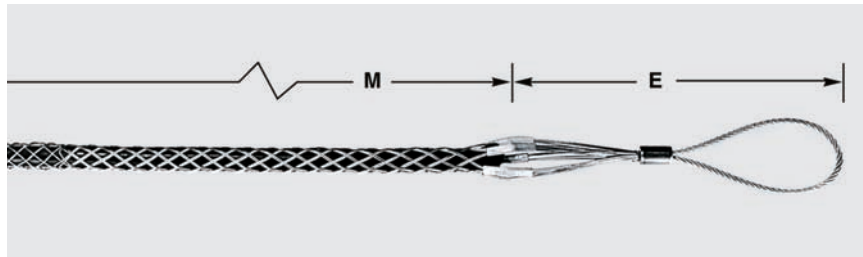

F-O Pulling Grip, Flexible Eye, Low Profile, Double/Single Weave Mesh

Cable Diameter Range Inches (cm)	Approx. Breaking Strength Lbs. (N)	E Approx. Inches (cm)	M Approx. Inches (cm)	Catalog Number
.10"-.22 (.25-.56)	900 (4,003)	7.5" (19)	10" (25)	033291193
.21"-.35" (.53-.89)	1,400 (6,227)	7.5" (19)	14" (36)	033291194
.32"-.48" (.81-1.22)	2,000 (8,896)	8.5" (22)	19" (48)	033291195
.42"-.61" (1.07-1.55)	2,500 (11,120)	8.5" (22)	21" (53)	033291196
.53"-.74" (1.35-1.88)	3,000 (13,344)	8.5" (22)	23" (58)	033291197
.64"-.87" (1.63-2.21)	4,200 (18,682)	8.5" (22)	25" (64)	033291198
.75"-1.00" (1.90-2.54)	4,200 (18,682)	8.5" (22)	28" (71)	033291199

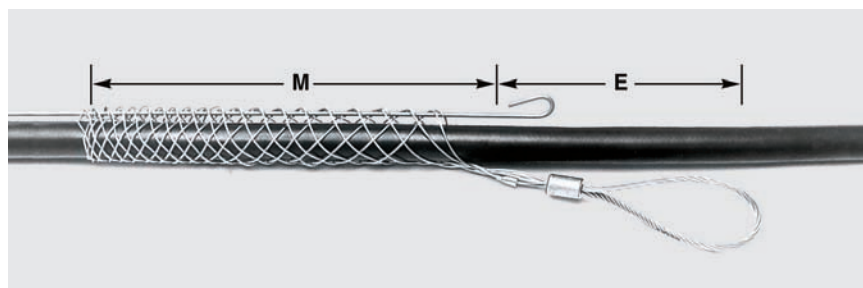

F-O Slack Pulling Grip, Split Mesh Rod Closing, Single Weave

Cable Diameter Range Inches (cm)	Approx. Breaking Strength Lbs. (N)	E Approx. Inches (cm)	M Approx. Inches (cm)	Catalog Number
.25"-.37" (.63-.94)	300 (1,334)	3" (7.6)	4.7" (12)	033291015
.38"-.49" (.97-1.24)	800 (3,558)	3" (7.6)	5" (13)	033291016
.50"-.61" (1.27-1.55)	800 (3,558)	3" (7.6)	7.5" (19)	033291017
.62"-.74" (1.57-1.88)	1,200 (5,338)	3" (7.6)	8" (20)	033291018

Note: E-Eye length.

M-Mesh length at nominal diameter.

Kellems® Wire Management Products
Fiber Optic Cable Support Grips
 Single Weave, Tin-Coated Bronze



F-O Single Eye Cable Support Grip, Closed Mesh, Single Weave

Cable Diameter Range Inches (cm)	Approx. Breaking Strength Lbs. (N)	E Approx. Inches (cm)	M Approx. Inches (cm)	Catalog Number
.18"-.25" (.46-.63)	300 (1,334)	3" (7.6)	1.7" (4.3)	022291000
.23"-.32" (.58-.81)	300 (1,334)	3" (7.6)	2.5" (6.4)	022291001
.30"-.39" (.76-.99)	300 (1,334)	4" (10)	2.5" (6.4)	022291002
.37"-.48" (.94-1.22)	300 (1,334)	5" (13)	4" (10)	022291003
.46"-.58" (1.17-1.47)	400 (1,779)	6" (15)	4" (10)	022291004
.56"-.71" (1.42-1.80)	600 (2,669)	7" (18)	5.5" (14)	022291005
.69"-.88" (1.75-2.24)	800 (3,558)	8" (20)	6" (15)	022291006

WARNING!

It is important that you read all breaking strength, safety and technical data relating to this product on pages T-54 through T-57.

For permanent support when cable end is available to be installed through grip.

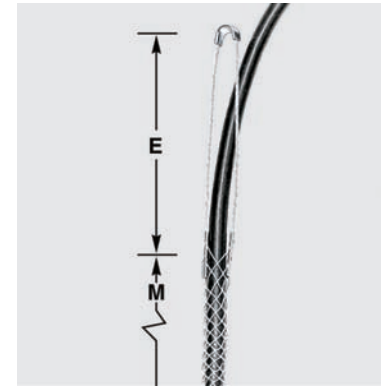

Single Eye, Closed Mesh, Single Weave

F-O Single Eye Cable Support Grip, Split Mesh, Rod Closing, Single Weave

Cable Diameter Range Inches (cm)	Approx. Breaking Strength Lbs. (N)	E Approx. Inches (cm)	M Approx. Inches (cm)	Catalog Number
.18"-.25" (.46-.63)	300 (1,334)	3" (7.6)	2.5" (6.4)	022291016
.23"-.32" (.58-.81)	300 (1,334)	3" (7.6)	2.5" (6.4)	022291017
.30"-.39" (.76-.99)	300 (1,334)	4" (10)	2.5" (6.4)	022291018
.37"-.48" (.94-1.22)	300 (1,334)	5" (13)	4" (10)	022291019
.46"-.58" (1.17-1.47)	400 (1,779)	6" (15)	5" (13)	022291020
.56"-.71" (1.42-1.80)	600 (2,669)	7" (18)	5" (13)	022291021
.69"-.88" (1.75-2.24)	800 (3,558)	8" (20)	6" (15)	022291022

For support when cable end not available.

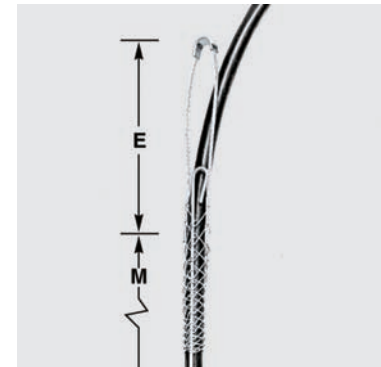

Single Eye, Split Mesh, Rod Closing, Single Weave

Note: E-Eye length.
 M-Mesh length at nominal diameter.



Kellems® Wire Management Products

Technical Information

Fiber Optic Pulling and Support Grips

Kellems has wide experience with grips for the new technology of fiber optic cable. As the industry leader in producing wire mesh grips for the stringent requirements of fiber optic applications, Kellems has developed several series of grips for use with fiber optic communications cable.

These grips include pulling grips with built in swivels, grips with steel ends to protect fragile cable ends, grips with low profiles to pull cables in tight places and the OPTISOK® an effective tool to place preterminated cables. Also available are grips to support fiber optic cable.

Select the Correct Fiber Optic Grip

Each Kellems grip is designed to work on a specific range of cable diameters.

- Step 1** Determine your cable outside diameter.
- Step 2** Find the grip size that encompasses your cable diameter.
- Step 3** Whenever possible, use a closed mesh that assembles over the cable end. If the cable end is not available, use a split mesh.
- Step 4** Where available, select an eye style that suits your needs.
- Step 5** Estimate the tension to be put on the grip, establish the working load you require and compare this to the listed approximate breaking strength of the grip to insure that the grip will be strong enough.

Safety And Working Load Factors For Wire Mesh Grips

The broad application of Kellems grips on a wide variety of objects requires that adequate safety factors be used to establish working loads. The approximate breaking strength of a Kellems grip represents an average calculation based on data established from actual direct tension testing done in our engineering laboratories.

It is impossible to catalog or guarantee a safety factor suitable for all applications as operating conditions are never the same. The tension, diameter, movement, number of objects gripped, gripping surface, and the attachments used are just some of the factors which vary with each application. These factors, together with the effects of abrasion, corrosion, prior use or abuse and any other variables of a specific application, must be considered by the user and the grip replaced as appropriate. Where the conditions of the application are not well defined or known

or where risk of injury to persons or property is involved, a greater safety factor should be utilized.

Under normal conditions, Kellems' recommended factor of safety is five for catalog listed pulling grips, and ten for catalog listed support grips.

Any warranty as to quality, performance or fitness for use of grips is always premised on the condition that the published breaking strengths apply only to new, unused grips, and that such products are properly stored, handled, used, maintained and inspected by the user at a frequency appropriate for the use and condition of the grip.

For grip applications on materials other than those that the grips have been specifically designed for, consult the factory.

Examples

Grip Style	Approx. Breaking Strength Lbs. (N)	Safety Factor	Max. Rec. Load Lbs. (N)	Catalog Number
Pulling Grips	2,500 (11,120)	5	500 (2,224)	033291196
Support Grips	400 (1,779)	10	40 (178)	022291004

The maximum recommended working load is the tension to be exerted on the grip in application with a margin of safety to take care of unforeseen and unusual circumstances.

It is the end-user's decision to determine how much of a safety factor is acceptable to for the application.

Fiber Optic Grip Materials

Material	Features	Product Group
Galvanized steel wire	<ul style="list-style-type: none"> • High strength • Not subject to continuous outside environment 	• Pulling grips
Tin-coated bronze wire	<ul style="list-style-type: none"> • Corrosion resistant for normal outside areas • Non-magnetic • Moderate strength 	• Support grips
Non-metallic braid	<ul style="list-style-type: none"> • Superior flex life • Non-conductive • Corrosion resistant • Moderate strength 	• OPTISOK®

Approvals

CSA Certification is indicated on appropriate product catalog pages.

Kellems® Wire Management Products

Technical Information

OPTISOK® Pulling Grips



Kellems offers a unique and simple to use tool for the installation of preconnectorized fiber optic cables, jumpers and bundles of twisted pair communication cables - the OPTISOK®.

The OPTISOK® is a highly flexible and expandable nonmetallic sleeve open on one end and with a pulling ring on the other. It will expand to enclose the larger group of fiber optic connectors and grab the cable below the connector bundle by wrapping and taping to provide a gripping tool that will grab the cable(s) below the connectors. The pulling ring can be attached to a pulling line or fish tape and the OPTISOK® will act as the pulling tool.

OPTISOK® will contain and protect the connector bundle and save time and labor by making the pulling job easier, protecting the connectors from possible damage during the pull and facilitating the passage of the connector bundle through cramped and tight spaces. The OPTISOK® can be used to pull cables through plenums, underfloor duct, office partitions, raised access floors and conduits. Three sizes are available for all applications.

How to Select OPTISOK®

- Identify connector bundle diameter to be inserted into the OPTISOK®.
- Choose appropriate catalog number based on size range.

Installation Information

- Step 1.** Expand open end of OPTISOK® and gently work in fiber optic connector bundle.
- Step 2.** Still gently, work connector bundle up to the forward section of the OPTISOK®.
- Step 3.** Starting at approximately 6" (15.2cm) from tail end of OPTISOK®, tightly fold over the OPTISOK® around cables and tape wrapped section 3" (7.62cm) past tail end onto the bundle.
- Step 4.** Securely attach pulling line or tape to pulling ring.

Note To remove OPTISOK® carefully unwrap tape and slide out cables and connectors or cut OPTISOK® away without damaging connectors or cables.

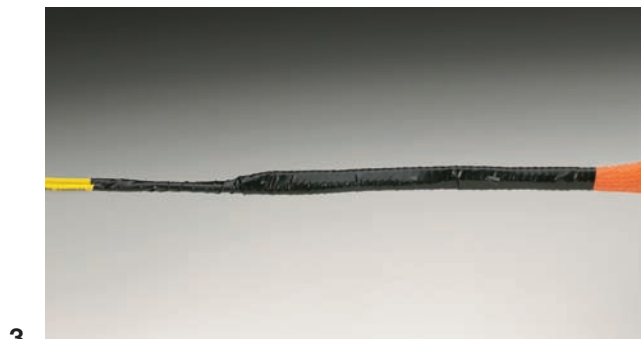
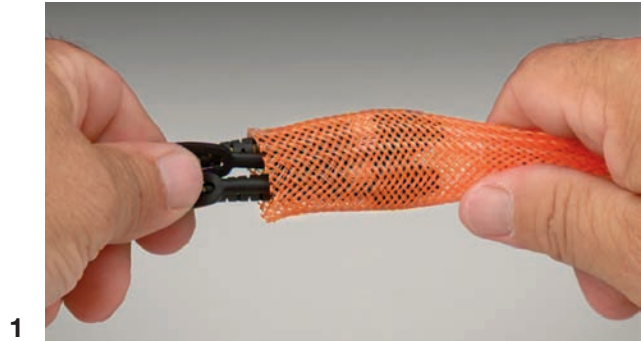



Kellems® Wire Management Products

Technical Information

Fiber Optic Pulling Grips

Pulling Grip for Loose Tube Fiber Optic Cable

Kellems offers a wire mesh specifically designed to pull loose tube fiber optic cable and meet the special pulling requirements recommended by fiber optic cable manufacturers.

Many fiber optic cable manufacturers require special cable preparation prior to pulling where a short section of the outer jacket is stripped off exposing the aramid strength member. This creates two cable diameters, one including the jacket and a second smaller diameter at the strength member. Kellems fiber grip with its special weave will accommodate and securely grab both diameters, at the outside jacket and the internal aramid strength member.

Additionally, this galvanized steel mesh grip has longer leads at the pulling eye to facilitate pulling the cable up through the top, a very low profile lug and eye to slip through tight areas, and short shoulders to protect the cable while maintaining the slim profile.

The grip can be used to pull cable overhead as well as underground through conduit and duct. It easily mates with a swivel and has the necessary strength to securely make pulls.

Application Information

- Prior to pulling cable, follow cable manufacturers' cable preparation recommendations.
- Never exceed cable manufacturers' pulling tension recommendations.
- Never use grips to approximate breaking strength safety factor of 5 recommended.

Pulling Grips for Other Outside Plant Cables, Swivel Eye, Flexible Eye, Split Style, Low Profile

Kellems Pulling Grips for fiber optic cable are made of high strength galvanized steel strand. They feature a multiweave mesh, with one-half the mesh length double weave, and the second half single weave. This special weave provides positive holding power while allowing the grip to remain flexible with no damage to the cable jacket. Added features include a steel nose cone which protects the cable end and allows the grip to pass easily through conduit and enclosures. The eye connects easily to a swivel or a pulling line. Several grip sizes are available to accommodate all diameters of fiber optic cable.

Application

Kellems Flexible Eye Pulling Grips for fiber optic cable are used for the installation of fiber optic communication lines either underground, overhead, through conduit or through enclosures. They will fit single cables or cable bundles, are easily installed on the cable, and are reusable.

Benefits

- High strength multiweave mesh for positive holding power.
- Highly flexible mesh to follow the pulling path of the cable.
- Steel nose cone reduces snags and hang-ups and protects cable end.
- Easily installed and removed.
- A dependable, reusable pulling tool.



Support Grips for Fiber Optic Cable

Kellems Support Grips for fiber optic cable are specially designed to hold the cable weight as it hangs in a vertical or horizontal position. Fiber optic cable must be supported and Kellems Grips provide the support easily and economically.

These grips are made of high grade, non-magnetic tin-coated bronze strand. They are offered in universal bale or single eye configurations and are available in either closed mesh (for use where the cable end is available) or in split mesh, rod closing (for installation on existing cable runs or at specific locations).

Split Support Grip Rod Closing Instructions

The stainless steel rod is a precise built-in feature which makes threading easy and fast. The strands of the mesh pass around the rod and match up with the strands from the opposite direction. The rod does not touch the cable at any point and therefore cannot cut the cable. Rod Closing Grips are reusable. They may be removed and reused as many times as desired.

Fast to Install

- Step 1.** Wrap the grip around the cable and thread the rod through the preformed loops with a corkscrew motion, using the curved end of the rod to engage the loops.
- Step 2.** The action required is a steady push and twist simultaneously. The fingers of the left hand are used to bring the loops together just ahead of the hook on the end of the rod.
- Step 3.** To remove, simply pull the rod out.





Kellems® Wire Management Products Hose Containment Grips

WARNING!

It is important that you read all breaking strength, safety and technical data relating to this product on pages T-42 through T-43.



Types of Attachment

The five attachment methods shown below provide unlimited flexibility of attachment to meet any condition.

Type E

Double Eye Grip, used where fastening is made with eyebolts or similar anchor terminations.

Type A

Single Eye Grip, used where fastening **MUST** be made from one point.

Type U

Universal Bale Grip, used to fasten around a structure or closed eye.

Type Y

Threaded bolt ($\frac{5}{16}$ -18 x 1 $\frac{1}{2}$ " long), used to fasten through drilled holes in plate.

Type F

Split fitting to fit AN-818 nuts. Fitting is positioned over nut and located with internal flange. A hose clamp is furnished and required to hold the fitting in correct position.

Note: It should be emphasized that Kellems® Hose Containment Grips are not to be used as a pressure reinforcing device for hose systems. These grips are custom made. Consult Technical Services for details.

Kellems Hose Containment Grips are used on high pressure, flexible hose lines to prevent the hose from whipping violently in the event of hose failure at the fitting. These grips will prevent serious injury to personnel and damage to equipment by holding the hose in place in the event of hose failure.

Kellems patented Hose Containment Grips are made of stainless steel with double weave mesh construction for high strength and come complete with hose clamps.

Kellems Hose Containment Grips are supplied in diameters, length and attachments to meet individual requirements. Contact the Wiring Device-Kellems factory for specific information. These grips help meet OSHA Federal Register 1926-302 (b), 1926-603 (9), (10), JIC H-1-1973 (H13.11) and JIC P-1-1975 (P11.34) requirements.

Kellems® Wire Management Products
Strain Relief for Flexible Cords
For Insulated Cables and Flexible, Liquidtight Conduits

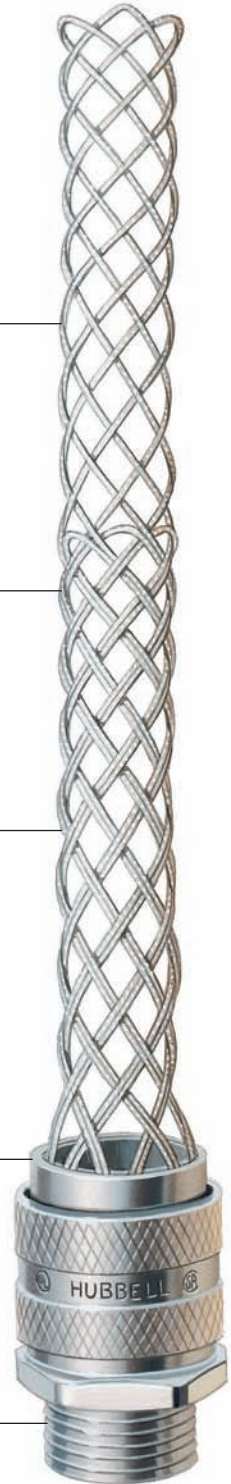

Endless weave provides easy cable/flexible conduit installation

Stainless steel mesh is corrosion resistant. Can be used inside or outside. It eliminates cable or flexible conduit pull out and reduces costly downtime

Multiweave grip gives cable arc-of-bend control minimizing cable damage and extending cable life. It is the strongest strain relief device available. Meets and exceeds all code requirements; prevents cable/conduit pull-out

A liquidtight fitting is available with both cable and conduit fittings; prevents liquids from running through the fitting into the enclosure

An N.P.T. and PG threaded body allows easy attachment to either threaded hub or knock-out in box

Kellems® Wire Management Products Deluxe Cord Grips

Aluminum Fittings, Stainless Steel Mesh, Liquidtight, for Insulated Cables



WARNING!

It is important that you read all breaking strength, safety and technical data relating to this product on pages T-71 through T-76.



Straight Male



Straight Male Thread

N.P.T. Thread Size Inches	Grip Diameter Range Inches	(cm)	Form Size	Catalog Number
3/8	.250"-.312"	(.63-.79)	F1	07401001
	.312"-.375"	(.79-.95)		07401002
	.375"-.437"	(.95-1.11)		07401003
1/2	.187"-.250"	(.47-.63)	F2	07401004
	.250"-.375"	(.63-.95)		07401006
	.375"-.500"	(.95-1.27)		07401008
1/2	.500"-.625"	(1.27-1.59)	F3	07401010
	.625"-.750"	(1.59-1.90)		074011247*
	.750"-.875"	(1.90-2.22)		074011248*
3/4	.187"-.250"	(.47-.63)	F2	07401011
	.250"-.375"	(.63-.95)		07401013
	.375"-.500"	(.95-1.27)		07401015
3/4	.500"-.625"	(1.27-1.59)	F3	07401017
	.625"-.750"	(1.59-1.90)		07401018
	.750"-.875"	(1.90-2.22)		074011249*
1	.375"-.500"	(.95-1.27)	F4	074011195
	.500"-.625"	(1.27-1.59)		07401019
	.625"-.750"	(1.59-1.90)		07401021
	.750"-.875"	(1.90-2.22)		07401023
	.875"-.1.000"	(2.22-2.54)		07401025
1	1.000"-.1.125"	(2.54-2.86)	F5	074011250*
	1.125"-.1.250"	(2.86-3.17)		074011028*
	1.250"-.1.375"	(3.17-3.49)		074011029*
1 1/4	.750"-.875"	(1.90-2.22)	F5	074011251
	.875"-.1.000"	(2.22-2.54)		07401026
	1.000"-.1.125"	(2.54-2.86)		07401027
	1.125"-.1.250"	(2.86-3.17)		07401028
1 1/2	1.250"-.1.375"	(3.17-3.49)	F5	074011178*
	.750"-.875"	(1.90-2.22)		074011252
	.875"-.1.000"	(2.22-2.54)		07401029
	1.000"-.1.125"	(2.54-2.86)		07401030
	1.125"-.1.250"	(2.86-3.17)		07401031
1 1/2	1.250"-.1.375"	(3.17-3.49)	F6	07401032
	1.312"-.1.437"	(3.33-3.65)		074011253
	1.437"-.1.562"	(3.65-3.97)		074011254*
	1.562"-.1.687"	(3.97-4.28)		074011255*
1 1/2	1.687"-.1.812"	(4.28-4.60)	F6	074011256*
	1.750"-.1.875"	(4.44-4.76)		074011257*
	1.250"-.1.375"	(3.17-3.49)		074011258
	1.312"-.1.437"	(3.33-3.65)		074011259
	1.437"-.1.562"	(3.65-3.97)		07401033
2	1.562"-.1.687"	(3.97-4.28)	F6	07401034
	1.687"-.1.812"	(4.28-4.60)		07401035
	1.750"-.1.875"	(4.44-4.76)		074011260
	1.812"-.1.937"	(4.60-4.92)		074011261
	1.937"-.2.062"	(4.92-5.24)		074011262*
2	2.062"-.2.187"	(5.24-5.55)	F7	074011263*
	2.187"-.2.312"	(5.55-5.87)		074011264*
	2.312"-.2.437"	(5.87-6.19)		074011265*
	1.688"-.1.812"	(4.29-4.60)		074011030
2 1/2	1.812"-.1.937"	(4.60-4.92)	F7	074011031
	1.937"-.2.062"	(4.92-5.24)		074011032
	2.062"-.2.187"	(5.24-5.55)		074011033
	2.187"-.2.312"	(5.55-5.87)		074011034
	2.312"-.2.437"	(5.87-6.19)		074011266*
3	1.937"-.2.062"	(4.92-5.24)	F7	074011036
	2.062"-.2.187"	(5.24-5.55)		074011037
	2.187"-.2.312"	(5.55-5.87)		074011038
	2.312"-.2.437"	(5.87-6.19)		074011039
3	2.437"-.2.625"	(6.19-6.67)	F8	074011186
	2.625"-.2.812"	(6.67-7.14)		074011187
	2.812"-.3.000"	(7.14-7.62)		074011188
	3.000"-.3.250"	(7.62-8.25)		074011189*

Note: Kellems® Deluxe Cord Grips are suitable for use in hazardous locations per Class I Div. 2, Class II Div. 1 & 2, Class III Div. 1 & 2 of the National Electric Code Sections 501.10(b)(2), 502.10(a)(2), 502.10(b)(2), 503.10(a)(2) and 503.10(b).

* Cable jacket may have to be stripped to pass through connector body.

Kellems® Wire Management Products

Deluxe Cord Grips

Aluminum Fittings, Stainless Steel Mesh, Liquidtight, for Insulated Cables



Straight Female Thread

N.P.T. Thread Size Inches	Grip Diameter Range Inches (cm)	Form Size	Catalog Number
1/2	.375"-.500" (.95-1.27)	F2	07401043
	.500"-.625" (1.27-1.59)		07401045
3/4	.500"-.625" (1.27-1.59)	F2	07401052
3/4	.625"-.750" (1.59-1.90)	F4	07401053

WARNING!

It is important that you read all breaking strength, safety and technical data relating to this product on pages T-71 through T-76.

90° Male Thread

N.P.T. Thread Size Inches	Grip Diameter Range Inches (cm)	Form Size	Catalog Number
3/8	.250"-.312" (.63-.79)	F1	07401071
	.312"-.375" (.79-.95)		07401072
	.375"-.437" (.95-1.11)		07401073
1/2	.187"-.250" (.47-.63)	F2	07401074
	.250"-.375" (.63-.95)		07401076
	.375"-.500" (.95-1.27)		07401078
	.500"-.625" (1.27-1.59)		07401080*
3/4	.375"-.500" (.95-1.27)	F3	07401081
	.500"-.625" (1.27-1.59)		07401083
	.625"-.750" (1.59-1.90)		07401084*
	.750"-.875" (1.90-2.22)		074011275*
	.500"-.625" (1.27-1.59)		07401085
1	.625"-.750" (1.59-1.90)	F4	07401087
	.750"-.875" (1.90-2.22)		07401089
	.875"-.1.000" (2.22-2.54)		07401091*
	1.000"-.1.125" (2.54-2.86)		074011229*
	.750"-.875" (1.90-2.22)		074011230
1 1/4	.875"-.1.000" (2.22-2.54)	F5	07401137
	1.000"-.1.125" (2.54-2.86)		07401108
	1.125"-.1.250" (2.86-3.17)		074011042*
	1.000"-.1.125" (2.54-2.86)		074011045
1 1/2	1.125"-.1.250" (2.86-3.17)	F5	074011046
	1.250"-.1.375" (3.17-3.49)		074011047
	1.312"-.1.437" (3.33-3.65)		074011233
2	1.437"-.1.562" (3.65-3.97)	F6	074011244
	1.687"-.1.812" (4.28-4.60)		074011246
	1.750"-.1.875" (4.44-4.76)		074011234*



Straight Female



90° Male



45° Male

45° Male Thread

N.P.T. Thread Size Inches	Grip Diameter Range Inches (cm)	Form Size	Catalog Number
1/2	.250"-.375" (.63-.95)	F2	074011236
	.375"-.500" (.95-1.27)		074011021
	.500"-.625" (1.27-1.59)		074011237*
3/4	.500"-.625" (1.27-1.59)	F3	074011049
	.625"-.750" (1.59-1.90)		074011051*
	.750"-.875" (1.90-2.22)		074011239*
1	.625"-.750" (1.59-1.90)	F4	074011055
	.750"-.875" (1.90-2.22)		074011057
	.875"-.1.000" (2.22-2.54)		074011199*
1 1/4	1.000"-.1.125" (2.54-2.86)	F5	074011059
	1.125"-.1.250" (2.86-3.17)		074011060

Note: Kellems® Deluxe Cord Grips are suitable for use in hazardous locations per Class I Div. 2, Class II Div. 1 & 2, Class III Div. 1 & 2 of the National Electric Code Sections 501.10(b)(2), 502.10(a)(2), 502.10(b)(2), 503.10(a)(2) and 503.10(b).

* Cable jacket may have to be stripped to pass through connector body.





Kellems® Wire Management Products

Deluxe Cord Grips

Nylon Fittings, Stainless Steel Mesh, Liquidtight, for Insulated Cables

WARNING!

It is important that you read all breaking strength, safety and technical data relating to this product on pages T-71 through T-76.



Straight Male



90° Male

Straight Male Thread

N.P.T. Thread Size Inches	Grip Diameter Range Inches (cm)	Form Size	Catalog Number
1/2	.187"-.250" (.47-.63)	F2	074011331
	.250"-.375" (.63-.95)		074011332
	.375"-.500" (.95-1.27)		074011333
	.500"-.625" (1.27-1.59)		074011334*
3/4	.375"-.500" (.95-1.27)	F3	074011335
	.500"-.625" (1.27-1.59)		074011336
	.625"-.750" (1.59-1.90)		074011337
	.750"-.875" (1.90-2.22)		074011338*
1	.625"-.750" (1.59-1.90)	F4	074011341
	.750"-.875" (1.90-2.22)		074011342
	.875"-.1.000" (2.22-2.54)		074011343
	1.000"-.1.125" (2.54-2.86)		074011344*

90° Male Thread

N.P.T. Thread Size Inches	Grip Diameter Range Inches (cm)	Form Size	Catalog Number
1/2	.250"-.375" (.63-.95)	F2	074011346
	.375"-.500" (.95-1.27)		074011347
	.500"-.625" (1.27-1.59)		074011348*
3/4	.375"-.500" (.95-1.27)	F3	074011349
	.500"-.625" (1.27-1.59)		074011350
	.625"-.750" (1.59-1.90)		074011351*

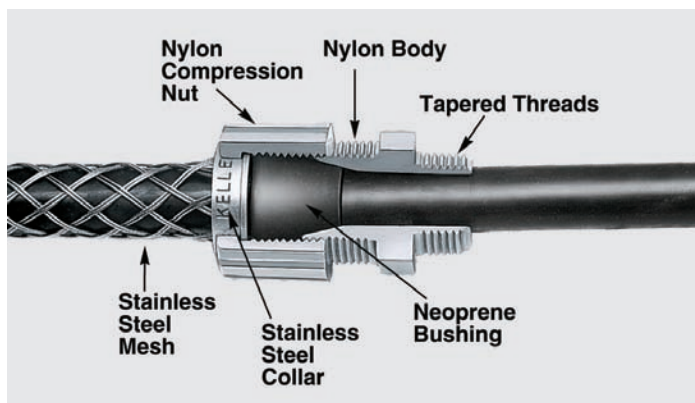

Note: Kellems® Deluxe Cord Grips are suitable for use in hazardous locations per Class I Div. 2, Class II Div. 1 & 2, Class III Div. 1 & 2 of the National Electric Code Sections 501.10(b)(2), 502.10(a)(2), 502.10(b)(2), 503.10(a)(2) and 503.10(b).

* Cable jacket may have to be stripped to pass through connector body.

Deluxe Cord Grips

Nylon Fittings, Non-metallic Mesh, Liquidtight, for Insulated Cables and
Stainless Steel Fittings, Stainless Steel Mesh, Liquidtight, for Insulated Cables



Nylon Fittings Non-metallic Mesh, Liquidtight for Insulated Cables Straight Male Thread

N.P.T. Thread Size Inches	Grip Diameter Range		Form Size	Catalog Number
	Inches	(cm)		
3/8	.187"-.250"	(.47-.63)	F1	CG304NM CG305NM CG306NM
	.250"-.312"	(.63-.79)		
	.312"-.375"	(.79-.95)		
1/2	.187"-.250"	(.47-.63)	F2	CG404NM CG406NM CG408NM
	.250"-.375"	(.63-.95)		
	.375"-.500"	(.95-1.27)		
3/4	.375"-.500"	(.95-1.27)	F3	CG608NM CG610NM CG612NM
	.500"-.625"	(1.27-1.59)		
	.625"-.750"	(1.59-1.90)		
1	.500"-.625"	(1.27-1.59)	F4	CG810NM CG812NM CG814NM CG816NM
	.625"-.750"	(1.59-1.90)		
	.750"-.875"	(1.90-2.22)		
	.875"-1.000"	(2.22-2.54)		

90° Male Thread

N.P.T. Thread Size Inches	Grip Diameter Range		Form Size	Catalog Number
	Inches	(cm)		
1/2	.250"-.375"	(.63-.95)	F2	CG40690NM CG40890NM
	.375"-.500"	(.95-1.27)		
3/4	.375"-.500"	(.95-1.27)	F3	CG60890NM CG61090NM CG61290NM*
	.500"-.625"	(1.27-1.59)		
	.625"-.750"	(1.59-1.90)		
1	.625"-.750"	(1.59-1.90)	F4	CG81290NM CG81490NM
	.750"-.875"	(1.90-2.22)		

Stainless Steel Fittings, Stainless Steel Mesh, Liquidtight for Insulated Cables Straight Male Thread

N.P.T. Thread Size Inches	Grip Diameter Range		Form Size	Catalog Number
	Inches	(cm)		
1/2	.187"-.250"	(.47-.63)	F2	CG404SST CG406SST CG408SST CG410SST
	.250"-.375"	(.63-.95)		
	.375"-.500"	(.95-1.27)		
	.500"-.625"	(1.27-1.59)		
3/4	.375"-.500"	(.95-1.27)	F2	CG608SST CG610SST
	.500"-.625"	(1.27-1.59)		
3/4	.625"-.750"	(1.59-1.90)	F3	CG612SST CG614SST
	.750"-.875"	(1.90-2.22)		
1	.500"-.625"	(1.27-1.59)	F4	CG810SST CG812SST CG814SST CG816SST
	.625"-.750"	(1.59-1.90)		
	.750"-.875"	(1.90-2.22)		
	.875"-1.000"	(2.22-2.54)		

WARNING! It is important that you read all breaking strength, safety and technical data relating to this product on pages T-71 through T-76.



Straight Male



90° Male



Straight Stainless Steel Male

Note: Kellems® Deluxe Cord Grips are suitable for use in hazardous locations per Class I Div. 2, Class II Div. 1 & 2, Class III Div. 1 & 2 of the National Electric Code Sections 501.10(b)(2), 502.10(a)(2), 502.10(b)(2), 503.10(a)(2) and 503.10(b).

* Cable jacket may have to be stripped to pass through connector body.



Kellems® Wire Management Products

PG and Metric Threaded Deluxe Cord Grips

Aluminum Fittings, Stainless Steel Mesh, Liquidtight, for Insulated Cables

WARNING! It is important that you read all breaking strength, safety and technical data relating to this product on pages T-71 through T-76.



Straight PG Male



Straight Metric Male

Straight PG* Male Thread

Hub Size	Cord Diameter Range		Form Size	Catalog Number
	Inches	(cm)		
PG16	.500"-.625"	(1.27-1.59)	F2	074PG16010
PG21	.500"-.625"	(1.27-1.59)	F2	074PG21010
PG21	.625"-.750"	(1.59-1.90)	F3	074PG211247
	.750"-.875"	(1.90-2.22)		074PG211248
PG29	.625"-.750"	(1.59-1.90)	F4	074PG29021
	.750"-.875"	(1.90-2.22)		074PG29023
	.875"-1.000"	(2.22-2.54)		074PG29025
PG29	1.125"-1.250"	(2.86-3.17)	F5	074PG291028**
PG36	1.125"-1.250"	(2.86-3.17)	F5	074PG36028**

Note: * Panzergewinde.

Straight Metric Male Thread

Hub Size	Cord Diameter Range		Form Size	Catalog Number
	Inches	(cm)		
M20	.500"-.625"	(1.27-1.59)	F2	074M20010
M25	.625"-.750"	(1.59-1.90)	F3	074M251247
	.750"-.875"	(1.90-2.22)		074M251248
M25	.500"-.625"	(1.27-1.59)	F2	074M25017
	.625"-.750"	(1.59-1.90)		074M32021
M32	.750"-.875"	(1.90-2.22)	F4	074M32023
	.875"-1.000"	(2.24-2.54)		074M32025
M32	1.125"-1.250"	(2.86-3.17)	F5	074M321028
	1.000"-1.125"	(2.54-2.86)		074M321250

Specifications

Material	Temperature Range
Aluminum	-30°F to +240°F (-34°C to +115°C).
Stainless Steel (Gotcha Rings)	-30°F to +240°F (-34°C to +115°C).
Neoprene (Bushings)	-30°F to +240°F (-34°C to +115°C).

Hazardous Locations	Suitable for use in hazardous locations per Class I Div. 2, Class II Div. 1 & 2, Class III Div. 1 & 2 N.E.C. Reference 501.10(b)(2), 502.10(a)(2), 502.10(b)(2), 503.10(a)(2) and 503.10(b).
---------------------	--

Approvals

Cord Connectors	UL Listed in accordance with Standard 514B.
Deluxe Cord Grips	UL Control numbers 898D and 899D.

Wet Locations	Suitable for use in wet locations when used with a listed nylon washer between box and fitting.
----------------------	---

Note: Kellems® Deluxe Cord Grips are suitable for use in hazardous locations per Class I Div. 2, Class II Div. 1 & 2, Class III Div. 1 & 2 of the National Electric Code Sections 501.10(b)(2), 502.10(a)(2), 502.10(b)(2), 503.10(a)(2) and 503.10(b).

** Cable jacket may have to be stripped to pass through connector body.

Dust-Tight Strain Relief Grips

Aluminum Fittings, Galvanized Steel Mesh, for Insulated Cables



WARNING!

It is important that you read all breaking strength, safety and technical data relating to this product on pages T-71 through T-76.

Non-Insulated, Wide Range Strain Relief

Thread Size	Cable Diameter Range Inches (cm)	Mesh Length @ Nom. Dia. Inches (cm)	Catalog Number
½ N.P.T.	.24"-.32" (.61-.81)	3.25" (8.25)	073031200
½ N.P.T.	.32"-.43" (.81-1.09)	3.75" (9.52)	073031201
½ N.P.T.	.43"-.54" (1.09-1.37)	4.75" (12.06)	073031202
¾ N.P.T.	.54"-.73" (1.37-1.85)	6.5" (16.51)	073031203
1 N.P.T.	.73"-.97" (1.85-2.46)	7" (17.78)	073031204
1¼ N.P.T.	.97"-1.25" (2.46-3.17)	9" (22.86)	073031205
PG29*	.73"-.97" (1.85-2.46)	7" (17.78)	073PG291204

Note: * Panzergewinde.

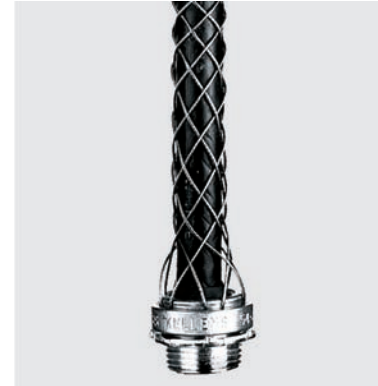

Non-Insulated

Insulated, Wide Range Strain Relief with Insulating Bushing

Thread Size	Cable Diameter Range Inches (cm)	Mesh Length @ Nom. Dia. Inches (cm)	Dim. A In. (cm)	Min. Space Between Grips In. (cm)	Catalog Number
½ N.P.S.	.24"-.32" (.61-.81)	3.25" (8.25)	1" (2.54)	1.25" (3.17)	073031206
½ N.P.S.	.32"-.43" (.81-1.09)	3.75" (9.52)	1" (2.54)	1.25" (3.17)	073031207
½ N.P.S.	.43"-.54" (1.09-1.37)	4.75" (12.06)	1" (2.54)	1.25" (3.17)	073031208
¾ N.P.S.	.54"-.73" (1.37-1.85)	6.5" (16.51)	1" (2.54)	1.5" (3.81)	073031209
1 N.P.S.	.73"-.97" (1.85-2.46)	7" (17.78)	1.313" (3.02)	1.75" (4.44)	073031210
1¼ N.P.S.	.97"-1.25" (2.46-3.17)	9" (22.86)	1.313" (3.02)	2.25" (5.71)	073031211
1½ N.P.T.	1.25"-1.50" (3.17-3.81)	11.75" (29.84)	1.313" (3.02)	2.5" (6.35)	073031212
2 N.P.T.	1.50"-1.70" (3.81-4.32)	13.25" (33.65)	1.375" (3.49)	3.25" (8.25)	073031213
2½ N.P.T.	1.70"-2.00" (4.32-5.08)	13.5" (34.29)	1.5" (3.81)	3.625" (9.21)	073031214
2½ N.P.T.	2.00"-2.45" (5.08-6.22)	13.75" (34.92)	1.5" (3.81)	3.625" (9.21)	073031215



Insulated



Kellems® Wire Management Products

I-Grips

Plastic-Coated, Galvanized Steel Mesh for Insulated Cables

WARNING!

It is important that you read all breaking strength, safety and technical data relating to this product on pages T-71 through T-76.



Application

Kellems® I-Grips will fit 2, 3, 4 and 5 wire Hubbell Insulgrip® plugs and connector bodies. The eye tabs fit under the nylon cord clamp and the screws slide through the eyelets, securing the grip in place.

These grips are for indoor use only.

Benefits

- Easily attached to Insulgrip plugs and connector bodies.
- Controls cable arc-of-bend.
- Provides heavy-duty strain relief.
- Fits all sizes.

I-Grips

Cable Diameter Range Inches (cm)	E Inches (cm)	M Inches (cm)	Catalog Number
.32"-.43" (.81-1.09)	1.25" (3.17)	4" (10.16)	07310001
.43"-.56" (1.09-1.42)	1.25" (3.17)	4.75" (12.06)	07310002
.56"-.73" (1.42-1.85)	1.50" (3.81)	6" (15.24)	07310003
.73"-.85" (1.85-2.16)	1.50" (3.81)	6.5" (16.51)	07310004
.85"-1.00" (2.16-2.54)	1.50" (3.81)	8" (20.32)	07310005
1.00"-1.25" (2.54-3.17)	1.50" (3.81)	10" (25.40)	07310006

Note: E-Eye length.

M-Mesh length at nominal diameter.

Eyelet hole diameter .203" (.52cm).

I-Grips should not be used on Insulgrip devices when "Seal-Tite®" weatherproof covers are to be installed.

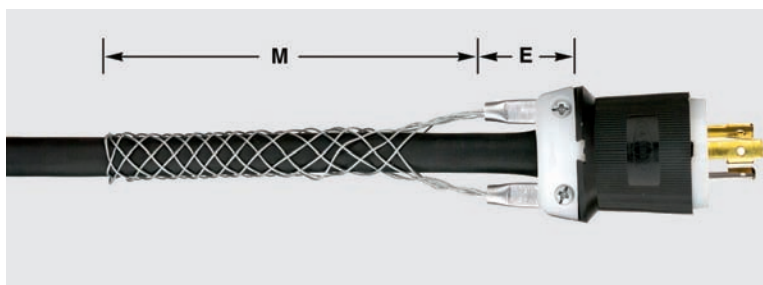

Kellems® Wire Management Products

Thread Adapters for Multi-Pin Connectors

Aluminum



Thread Adapters for Multi-Pin Connectors

Kellems® Thread Adapters are devices formatting AN-MS connectors and other multi-pin connectors to Kellems grips with N.P.T. threaded fittings. They are made of aluminum with internal threads and replace the connector cord clamp. These adapters permit the installation of Kellems Grips, to prevent cable or conduit pull-out and control arc-of-bend.

Applications

Thread adapters allow the installation of Kellems® Grips on multi-pin connectors at electrical consoles, mobile equipment, control switches, assembly equipment and testing machines.

Benefits

- Easy installation.
- Allows the use of Kellems grips.
- Extends connector and cable life.

Thread Adapters for Multi-Pin Connectors

Thread Adapters					Deluxe Cord Grips		Strain Relief Grips		Liquidtight Conduit Grips (Insulated Throat)
AN-MS Connector Size**	AN-MS Cable Clamp Number***	Thread Size A in.	N.P.T. Thread Size B in.	Catalog Number	Cable Diameter Range Inches (cm)	Catalog Number	Cable Diameter Range Inches (cm)	Catalog Number	Catalog Number
8S, 10S	3057-3	½" x 28"		091041000	.250"-.312" (.63-.79)	07401001			
10SL, 12, 12S	3057-4	⅝" x 24"	⅜"	091041001	.312"-.375" (.79-.95)	07401002			
14, 14S	3057-6	¾" x 20"		091041002	.375"-.437" (.95-1.11)	07401003			
14, 14S	3057-6	¾" x 20"		091041003	.187"-.250" (.47-.63)	07401004	.24"-.32" (.61-.81)	073031200	—
16, 16S	3057-8	⅞" x 20"	½"	091041004	.250"-.375" (.63-.95)	07401006	.32"-.43" (.81-1.09)	073031201	074093512
18	3057-10	1" x 20"		091041006	.375"-.500" (.95-1.27)	07401008	.43"-.54" (1.09-1.37)	073031202	—
					.500"-.625" (1.27-1.59)	07401010*			
16, 16S	3057-8	⅞" x 20"		091041005	.187"-.250" (.47-.63)	07401011			
18	3057-10	1" x 20"	¾"	091041007	.250"-.375" (.63-.95)	07401013			
20, 22	3057-12	1⅜" x 18"		091041008	.375"-.500" (.95-1.27)	07401015	.54"-.74" (1.37-1.85)	073031203	074093513
					.500"-.625" (1.27-1.59)	07401017			
					.625"-.750" (1.59-1.90)	07401018			
20, 22	3057-12	1⅜" x 18"		091041009	.375"-.500" (.95-1.27)	074011195			
24, 28	3057-16	1⅞" x 18"		091041010	.500"-.625" (1.27-1.59)	07401019			
32	3057-20	1¾" x 18"	1	091041012	.625"-.750" (1.59-1.90)	07401021	.73"-.97" (1.85-2.46)	073031204	074093514
36	3057-24	2" x 18"		091041015	.750"-.875" (1.90-2.22)	07401023			
					.875"-.1.000" (2.22-2.54)	07401025			
24, 28	3057-16	1⅞" x 18"		091041011	.750"-.875" (1.90-2.22)	074011251			
32	3057-20	1¾" x 18"	1¼"	091041013	.875"-.1.000" (2.22-2.54)	07401026			
36	3057-24	2" x 18"		091041016	1.000"-.1.125" (2.54-2.86)	07401027	.97"-.1.25" (2.46-3.17)	073031205	074093515
					1.125"-.1.375" (2.86-3.17)	07401028			
32	3057-20	1¾" x 18"		091041014	.875"-.1.000" (2.22-2.54)	07401029			
36	3057-24	2" x 18"	1½"	091041017	1.000"-.1.125" (2.54-2.86)	07401030	—		074093516
40	3057-28	2¼" x 16"		091041019	1.125"-.1.250" (2.86-3.17)	07401031			
					1.250"-.1.375" (3.17-3.49)	07401032			

Note: * Cable jacket may have to be stripped to pass through connector body.

** Number stamped on connector shell.

*** Number stamped on clamp shell.

Example

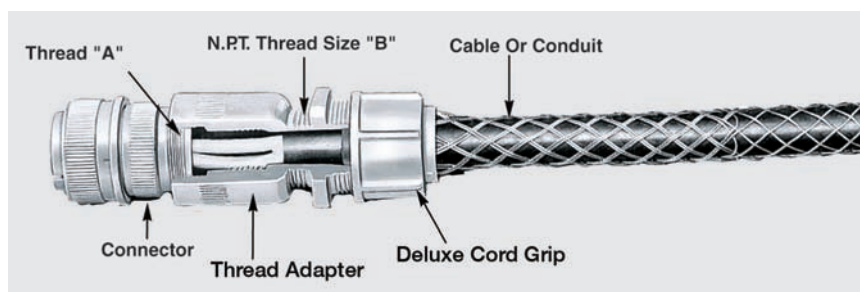

Thread Adapter



091041006



Kellems® Wire Management Products

Strain Relief for Liquidtight Conduit

Steel Fitting, Stainless Steel Mesh for Liquidtight Metal Conduit and PolyTuff I Non-Metallic Conduit

WARNING!

It is important that you read all breaking strength, safety and technical data relating to this product on pages T-77, T-79 and T-80.



Straight with Male Fitting



90° Angle with Male Fitting

Benefits

- Helps prevent conduit pull-out and damage at the fitting.
- Reduces equipment downtime.

Straight With Male Fitting

Conduit Trade Size Inches	N.P.T. Fitting Size Inches	Mesh Length Inches (cm)	Catalog Number (Insulated)	Catalog Number (Non-insulated)
3/8	1/2	3" (7.62)	074093511	074093401
1/2	1/2	3.5" (8.89)	074093512	074093402
3/4	3/4	4" (10.16)	074093513	074093403
1	1	5" (12.70)	074093514	074093404
1 1/4	1 1/4	6" (15.24)	074093515	074093405
1 1/2	1 1/2	6.75" (17.14)	074093516	074093406
2	2	8" (20.32)	074093518	074093408
2 1/2	2 1/2	9.75" (24.76)	074093520	074093410
3	3	11" (27.94)	074093522	074093412
4	4	14" (35.56)	074093526	—

90° Angle With Male Fitting

Conduit Trade Size Inches	N.P.T. Fitting Size Inches	Mesh Length Inches (cm)	Catalog Number (Insulated)	Catalog Number (Non-insulated)
3/8	1/2	3" (7.62)	074093541	074093421
1/2	1/2	3.5" (8.89)	074093542	074093422
3/4	3/4	4" (10.16)	074093543	074093423
1	1	5" (12.70)	074093544	074093424
1 1/4	1 1/4	6" (15.24)	074093545	074093425
1 1/2	1 1/2	6.75" (17.14)	074093546	074093426
2	2	8" (20.32)	074093548	074093428
2 1/2	2 1/2	9.75" (24.76)	074093550	—
3	3	11" (27.94)	074093552	—

Note: For use with Liquidtight Metal conduit and PolyTuff I Non-Metallic conduit.

Strain Relief for Liquidtight Conduit

Steel Fitting, Stainless Steel Mesh for Liquidtight Metal Conduit and PolyTuff I Non-Metallic Conduit



Straight With Chase Fitting

Conduit Trade Size Inches	N.P.T. Fitting Size Inches	Mesh Length Inches (cm)	Catalog Number
1/2	1/2	3.5" (8.89)	07406079
3/4	3/4	4" (10.16)	07406080
1	1	5" (12.70)	07406081
1 1/4	1 1/4	6" (15.24)	07406082
1 1/2	1 1/2	6.75" (17.14)	07406083

WARNING!

It is important that you read all breaking strength, safety and technical data relating to this product on pages T-77, T-79 and T-80.



Straight with Chase Connector

45° Angle With Male Fitting

Conduit Trade Size Inches	N.P.T. Fitting Size Inches	Mesh Length Inches (cm)	Catalog Number (Insulated)	Catalog Number (Non-insulated)
3/8	1/2	3" (7.62)	074093561	074093441
1/2	1/2	3.5" (8.89)	074093562	074093442
3/4	3/4	4" (10.16)	074093563	074093443
1	1	5" (12.70)	074093564	074093444
1 1/4	1 1/4	6" (15.24)	074093565	074093445
1 1/2	1 1/2	6.75" (17.14)	074093566	074093446
2	2	8" (20.32)	074093568	074093448

Note: For use with Liquidtight Metal conduit and PolyTuff I Non-Metallic conduit.



45° Angle with Male Fitting



Kellems® Wire Management Products

Strain Relief for Liquidtight Conduit

Steel Fitting, Stainless Steel Mesh for UL Type A Liquidtight Conduit

WARNING!

It is important that you read all breaking strength, safety and technical data relating to this product on pages T-78 through T-80.



Straight Male with Fitting



90° Angle

Straight Male Hubbell Fitting

Conduit Trade Size Inches	N.P.T. Fitting Size Inches	Mesh Length Inches (cm)	Catalog Number
3/8	1/2	3.75" (9.52)	H038CNK
1/2	1/2	4.5" (11.43)	H050CNK
3/4	3/4	6.25" (15.87)	H075CNK
1	1	7.5" (19.05)	H100CNK
1 1/4	1 1/4	9" (22.86)	H125CNK
1 1/2	1 1/2	13.5" (34.29)	H150CNK
2	2	14.5" (36.83)	H200CNK

90° Male Hubbell Fitting

Conduit Trade Size Inches	N.P.T. Fitting Size Inches	Mesh Length Inches (cm)	Catalog Number
3/8	1/2	3.75" (9.52)	H0389CNK
1/2	1/2	4.5" (11.43)	H0509CNK
3/4	3/4	6.25" (15.87)	H0759CNK
1	1	7.5" (19.05)	H1009CNK
1 1/4	1 1/4	9" (22.86)	H1259CNK
1 1/2	1 1/2	13.5" (34.29)	H1509CNK
2	2	14.5" (36.83)	H2009CNK









Kellems Strain Relief Grips are designed to prevent tension from being transmitted to joints and terminals on electrical cord, cable and conduit. In most applications, a Kellems grip for strain relief is stronger than the cable itself and gives much greater security than the use of a fitting alone. Kellems Grips for strain relief help make electrical systems safer, and save money by minimizing downtime from costly electrical failure due to cable pull-out. Kellems Grips also aid in compliance with the National Electric Code's terminal tension protection requirements.

Select the Correct Grip for Strain Relief

Kellems Grips for strain relief are designed to fit on electrical cord, cable or flexible conduit.

- Step 1** Refer to the chart below to determine the grip style best suited for your application.
- Step 2** Determine your cable outside diameter or conduit size.
- Step 3** Locate environment—indoors or outdoors.
- Step 4** Decide if a liquidtight seal is required.
- Step 5** Select N.P.T. size and fitting style.

Strain Relief System Selection Chart

Grip Type	Application	Features	Cord or Conduit Range Inches (cm)	Type Fitting or Attachment	Page Number
Deluxe Cord Aluminum Fitting/ Stainless Steel Grip 	Outdoors or indoors where subjected to moisture or splash. Examples are crane and hoist pendant drop stations, hand tools, pumps and processing equipment.	Aluminum fittings, stainless steel mesh, neoprene oil-and-watertight bushing. Double-single weave.	.187"-3.250" (.47-8.25)	N.P.T., PG, and metric aluminum, male straight, 45° male, 90° male, female straight. Thread sizes 3/8"-3".	T-60, T-61, T-64
Deluxe Cord Nylon Fitting/ Stainless Steel Grip 	Outdoors or indoors where subjected to moisture or splash. Examples are marine and food processing equipment.	Nylon fitting, stainless steel mesh, double-single weave, neoprene oil-and-watertight bushing.	.187"-1.125" (.47-2.86)	N.P.T. nylon, male straight, 90° male. Thread sizes 1/2"-1".	T-62
Deluxe Cord Nylon Fitting/ Non-metallic Grip 	Indoor or outdoors. Provides liquidtight seal, where exposed to moisture. Excellent for oil refining and chemical processing.	Non-metallic grip is corrosion resistant, nonconductive and provides superior gripping and flexing benefits. Neoprene liquidtight bushing. Nylon fitting.	.187"-1.000" (.47-2.54)	N.P.T. nylon, straight male, thread sizes 3/8"-1" 90° male, thread sizes 1/2"-1".	T-63
Deluxe Cord Stainless Steel Fitting And Grip 	Indoor or outdoor use where exposed to moisture. Very strong for heavy abuse areas such as drilling platforms, steel mills and mines.	Stainless steel fitting and grip for strength. Neoprene liquidtight bushing. Double/single weave grip.	.187"-1.000" (.47-2.54)	Straight male Only with N.P.T. Thread sizes 1/2"-1".	T-63
Dust-Tight Strain Relief 	Indoor use only for wiring of electrical enclosures, machine tools, portable power tools, bus drop cable systems.	Neoprene gasket—seals out chips, dirt, dust. One piece design with galvanized steel mesh. Insulating bushing available. Zinc-plated steel locknut.	.240"-2.450" (.61-6.22)	Straight male N.P.S. or N.P.T.	T-65
Liquidtight Flexible Conduit Grip (Metal and Non-Metallic) 	Wiring of machine tools, electrical enclosures, motors and systems where metallic liquidtight flexible conduit is subjected to vibration, flexure, motion or strain.	Stainless steel mesh, liquidtight fittings. Sealing "O" rings (optional). Choice of fittings.	.375"-4.000" trade sizes	N.P.T. 1/2"-4", Hubbell fittings, Male straight, 45° male, 90° male, female straight.	T-68, T-69
Liquidtight Flexible Conduit Grip (UL Type A) 	Wiring or machine tools, electrical enclosures, motors and systems where conduit is subject to vibration and strain.	Stainless steel mesh, liquidtight fittings with "O" ring and locknut.	.375"-2.008" trade size male	N.P.T. steel, Hubbell fittings, straight male, 90° Thread sizes 1/2"-2".	T-70





Kellems® Wire Management Products

Technical Information*Strain Relief Grips***Wire Mesh Grip Materials**

Material	Features	Product Group
Galvanized steel wire	<ul style="list-style-type: none"> • High strength • Not subject to continuous outside environment 	<ul style="list-style-type: none"> • Strain relief grips • I-Grips
Stainless steel wire (302/304)	<ul style="list-style-type: none"> • High strength • Corrosion resistant • Slightly magnetic 	<ul style="list-style-type: none"> • Deluxe cord grips • Liquidtight, flexible, metal conduit grips • UL type A conduit grips
Non-metallic strand	<ul style="list-style-type: none"> • Superior flex life • Non-conductive • Corrosion resistant • Moderate strength 	<ul style="list-style-type: none"> • Non-metallic deluxe cord grips

Operating Temperatures

Material	Temperature Range
Aluminum	-40°F to +300°F (-40°C to +149°C).
Aluminum Deluxe Cord Grips	-30°F to +240°F (-34°C to +115°C).
Non-Metallic Deluxe Cord Grips	-30°F to +225°F (-34°C to +107°C).
Nylon	-40°F to +225°F (-40°C to +107°C).
Nylon Fitting with Stainless Steel Mesh	-40°F to +225°F (-40°C to +107°C).
Stainless Steel	-60°F to +1000°F (-51°C to +537°C).
Stainless Steel Deluxe Cord Grips	-30°F to +240°F (-34°C to +115°C).
Neoprene (Bushings)	-30°F to +240°F (-34°C to +115°C).

Hazardous Locations

	Product Categories
The product categories listed to the right are suitable for use in hazardous locations per Class I Div. 2, Class II Div. 1 & 2, Class III Div. 1 & 2.	Deluxe cord grip, aluminum fitting; Deluxe cord grip, nylon fitting; Deluxe cord grip, non-metallic; Sealtite conduit grips; Dusttight strain relief grips.

Flammability

Non-metallic deluxe cord grips will not support combustion. Listed below are the ratings.

Component	Rating
Mesh grip	UL 94HB.
Fitting	UL 94V-2.

Approvals

UL Listing and CSA Certification are indicated on appropriate product catalog pages.

Agency	UL Control Number
Underwriters Laboratories Inc.	898D and 899D.

Wet Locations

	Product Categories
The products noted to the right are suitable for use in wet locations when a listed sealing ring is used between box and fitting.	Deluxe cord grip, aluminum fitting; Deluxe sealing ring cord grip; Deluxe cord grip, non-metallic; Sealtite conduit grips; Hubbell non-metallic conduit grips; Cord connectors; Hubbell Juniors; PolyTuff® connectors; Hubbell sealtite conduit connectors.

**Form Size Definition**

The term “Form Size” refers to the physical mass or overall dimensions of a cord connector. Form 1 is the smallest size, Form 8 is the largest size.

Knockout Holes

N.P.T. Hub Size Inches	Knockout Hole Recommended Min. to Max. Inches (cm)
1/4	.540" to .570" (1.37-1.45)
3/8	.671" to .701" (1.70-1.78)
1/2	.859" to .906" (2.18-2.30)
3/4	1.094" to 1.141" (2.78-2.90)
1	1.359" to 1.406" (3.45-3.57)
1 1/4	1.719" to 1.766" (4.37-4.49)
1 1/2	1.969" to 2.016" (5.00-5.12)
2	2.453" to 2.500" (6.23-6.35)
2 1/2	2.953" to 3.000" (7.50-7.62)
3	3.578" to 3.625" (9.09-9.21)

Product Data**Deluxe Cord Grips, Liquidtight for Insulated Cables**

Deluxe Cord Grips helps to alleviate pull tension on terminals, control cable arc-of-bend, prevent cord pull-out, and provide a liquidtight seal. They are offered with either aluminum, stainless steel or nylon fittings in a variety of configurations and N.P.T. thread sizes. Additionally, a completely non-metallic product is offered on page T-63.

Application

Deluxe Cord Grips are used indoors or outdoors to help prevent cord pull-out, and where cables are subjected to moisture, splash or submersion. Specific uses are: wiring enclosures, pendant stations, hand tools, construction, processing and material handling equipment, pumps, motors and machine tools.

Benefits

- Helps to prevent cable pull-out.
- Controls cable arc-of-bend.
- Provides a liquidtight seal.
- Corrosion resistant stainless steel mesh with aluminum collar.



Kellems® Wire Management Products

Technical Information

Strain Relief Grips

Deluxe Cord Grips Fitting Dimensions

Straight Hubbell Connectors

F N.P.T. (Inches)	Form	Aluminum, Inches (cm)						Nylon, Inches (cm)					Stainless Steel, Inches (cm)							
		A Dia.	B Ref.	C	D Throat Dia.	E A/C*	E A/F*	A Dia.	B Ref.	C	D Throat Dia.	E A/C*	E A/F*	A A/C*	A A/F	B	C	D Throat Dia.	E A/C*	E A/F*
3/8-18	1	.88" (2.24)	.90" (2.29)	.46" (1.17)	.44" (1.12)	.99" (2.51)	.88" (2.24)	1.00" (2.54)	1.10" (2.79)	.43" (1.09)	.45" (1.14)	1.00" (2.54)	.93" (2.36)	1.01" (2.57)	.88" (2.24)	.90" (2.29)	.46" (1.17)	.45" (1.14)	.87" (2.21)	.75" (1.90)
1/2-14	1	.88" (2.24)	.90" (2.29)	.46" (1.17)	.44" (1.12)	1.00" (2.54)	.88" (2.24)	1.00" (2.54)	1.10" (2.79)	.46" (1.17)	.45" (1.14)	1.00" (2.54)	.93" (2.36)	-	-	-	-	-	-	-
1/2-14	2	1.13" (2.87)	1.10" (2.79)	.55" (1.40)	.64" (1.63)	1.11" (2.82)	1.00" (2.54)	1.32" (3.35)	1.50" (3.81)	.53" (1.35)	.58" (1.47)	1.25" (3.17)	1.12" (2.84)	1.30" (3.30)	1.13" (2.87)	1.10" (2.79)	.54" (1.37)	.63" (1.60)	1.16" (2.95)	1.00" (2.54)
1/2-14	3	1.38" (3.51)	1.50" (3.81)	.55" (1.40)	.64" (1.63)	1.40" (3.56)	1.25" (3.17)	-	-	-	-	-	-	-	-	-	-	-	-	-
3/4-14	2	1.13" (2.87)	1.10" (2.79)	.55" (1.40)	.64" (1.63)	1.29" (3.28)	1.13" (2.87)	-	-	-	-	-	-	-	-	-	-	-	-	-
3/4-14	3	1.38" (3.51)	1.50" (3.81)	.55" (1.40)	.82" (2.08)	1.40" (3.56)	1.25" (3.17)	1.56" (3.96)	1.60" (4.06)	.55" (1.40)	.77" (1.96)	1.44" (3.66)	1.31" (3.33)	1.59" (4.04)	1.38" (3.51)	1.30" (3.30)	.56" (1.42)	.81" (2.06)	1.44" (3.66)	1.25" (3.17)
1-11 1/2	3	-	-	-	-	-	-	-	-	-	-	-	-	-	-	-	-	-	-	-
1-11 1/2	4	1.75" (4.44)	1.60" (4.06)	.71" (1.80)	1.02" (2.59)	1.81" (4.60)	1.62" (4.11)	1.88" (4.78)	1.75" (4.44)	.70" (1.78)	1.01" (2.57)	1.84" (4.67)	1.63" (4.14)	2.02" (5.13)	1.75" (4.44)	1.40" (3.56)	.70" (1.78)	1.03" (2.62)	1.88" (4.78)	1.63" (4.14)
1-11 1/2	5	2.31" (5.87)	1.70" (4.32)	.66" (1.68)	1.01" (2.57)	2.28" (5.79)	2.00" (5.08)	-	-	-	-	-	-	-	-	-	-	-	-	-
1 1/4-11 1/2	5	2.31" (5.87)	1.70" (4.32)	.74" (1.88)	1.26" (3.20)	2.28" (5.79)	2.12" (5.38)	-	-	-	-	-	-	-	-	-	-	-	-	-
1 1/2-11	5	2.31" (5.87)	1.70" (4.32)	.74" (1.88)	1.38" (3.51)	2.28" (5.79)	2.12" (5.38)	-	-	-	-	-	-	-	-	-	-	-	-	-
1 1/2-11 1/2	6	3.00" (7.62)	2.20" (5.59)	.75" (1.90)	1.50" (3.81)	2.97" (7.54)	2.75" (6.98)	-	-	-	-	-	-	-	-	-	-	-	-	-
2-11 1/2	6	3.00" (7.62)	2.20" (5.59)	.80" (2.03)	1.92" (4.88)	3.24" (8.24)	3.00" (7.62)	-	-	-	-	-	-	-	-	-	-	-	-	-
2-11 1/2	7	3.85" (9.78)	2.70" (6.86)	.88" (2.24)	1.94" (4.93)	4.05" (10.29)	3.75" (9.52)	-	-	-	-	-	-	-	-	-	-	-	-	-
2 1/2-8	7	3.85" (9.78)	2.70" (6.86)	1.30" (3.30)	2.32" (5.89)	4.34" (11.02)	4.02" (10.21)	-	-	-	-	-	-	-	-	-	-	-	-	-
2 1/2-8	8	4.75" (12.06)	2.70" (6.86)	1.25" (3.17)	2.38" (6.05)	4.86" (12.34)	4.50" (11.43)	-	-	-	-	-	-	-	-	-	-	-	-	-
3-8	7	3.85" (9.78)	2.70" (6.86)	1.30" (3.30)	2.54" (6.45)	4.34" (11.02)	4.01" (10.21)	-	-	-	-	-	-	-	-	-	-	-	-	-
3-8	8	4.50" (11.43)	2.70" (6.86)	1.38" (3.51)	3.00" (7.62)	4.86" (12.34)	4.50" (11.43)	-	-	-	-	-	-	-	-	-	-	-	-	-

Note: *A/C— Across Corners; A/F—Across Flats.

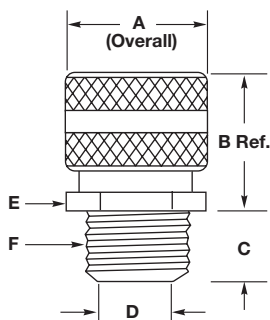

Dimensions shown are approximate and are subject to change without notice.



Deluxe Cord Grips Fitting Dimensions

45° Hubbell Connectors

		Aluminum, Inches (cm)						
F N.P.T. (Inches)	Form	A Ref	B Ref	C	D Throat Dia.	E Across Comers	Across Flats	G Dia.
1/2-14	2	2.00" (5.08)	1.90" (4.83)	.550" (1.40)	.560" (1.42)	1.270" (3.23)	1.110" (2.79)	1.125" (2.86)
3/4-14	3	2.30" (5.84)	2.50" (6.53)	.560" (1.42)	.750" (1.90)	1.480" (3.76)	1.281" (3.25)	1.375" (3.49)
1-11 1/2	4	2.60" (6.60)	2.80" (7.11)	.700" (1.78)	1.000" (2.54)	1.690" (4.29)	1.500" (3.81)	1.750" (4.44)
1 1/4-11 1/2	5	3.90" (9.91)	3.90" (9.91)	.740" (1.88)	1.250" (3.17)	2.45" (6.22)	2.125" (5.40)	2.310" (5.87)
1 1/2-11 1/2	5	3.90" (9.91)	3.90" (9.91)	.740" (1.88)	1.500" (3.81)	2.45" (6.22)	2.125" (5.40)	2.310" (5.87)

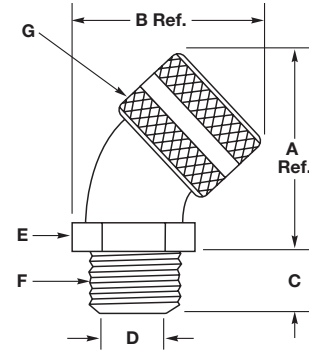

90° Hubbell Connectors

		Aluminum, Inches (cm)							Nylon, Inches (cm)						
F N.P.T. (Inches)	Form	A	B Ref	C	D Throat Dia.	E A/C*	A/F*	G Dia.	A	B Ref	C	D Throat A/C*	E A/F Dia.	G	
3/8-18	1	1.27" (3.23)	2.00" (5.08)	.460" (1.17)	.440" (1.12)	1.15" (2.92)	1.10" (2.79)	.875" (2.22)	—	—	—	—	—	—	
1/2-14	2	1.56" (3.96)	2.30" (5.84)	.500" (1.27)	.546" (1.39)	1.30" (3.30)	1.13" (2.87)	1.125" (2.86)	1.41" (3.58)	2.50" (6.35)	.550" (1.40)	.575" (1.46)	1.23" (3.12)	1.12" (2.82)	1.315" (3.34)
3/4-14	3	1.79" (4.55)	2.80" (7.11)	.560" (1.42)	.765" (1.94)	1.49" (3.78)	1.31" (3.33)	1.375" (3.49)	1.65" (4.19)	2.81" (7.14)	.560" (1.42)	.765" (1.94)	1.42" (3.61)	1.29" (3.28)	1.560" (3.96)
1-11 1/2	4	2.08" (5.28)	3.20" (8.13)	.700" (1.78)	1.000" (2.54)	1.70" (4.32)	1.50" (3.81)	1.750" (4.44)	1.99" (5.05)	3.30" (8.38)	.700" (1.78)	1.010" (2.57)	1.82" (4.62)	1.60" (4.06)	1.875" (4.76)
1 1/4-11 1/2	5	3.18" (8.08)	4.30" (10.92)	.730" (1.85)	1.260" (3.20)	2.47" (6.27)	2.15" (5.46)	2.310" (5.87)	—	—	—	—	—	—	—
1 1/2-11 1/2	5	3.18" (8.08)	4.30" (10.92)	.750" (1.92)	1.500" (3.81)	2.47" (6.27)	2.15" (5.46)	2.310" (5.87)	—	—	—	—	—	—	—
2-11 1/2	6	3.51" (8.92)	5.50" (13.97)	.800" (2.03)	1.920" (4.88)	2.98" (7.57)	2.78" (7.06)	3.000" (7.62)	—	—	—	—	—	—	—

Note: *A/C - Across Corners; A/F - Across Flats.

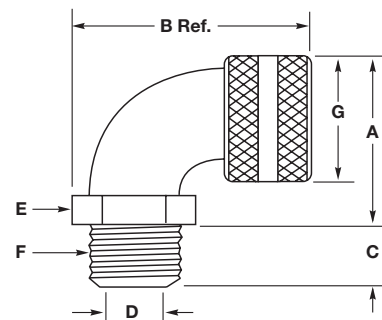

Dimensions shown are approximate and are subject to change without notice.



Kellems® Wire Management Products

Technical Information

Strain Relief Grips

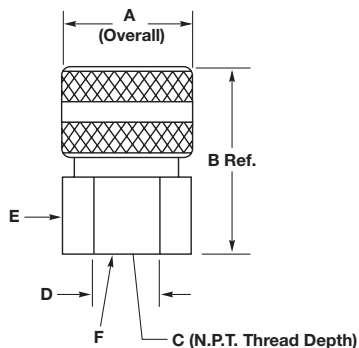

Deluxe Cord Grips Fitting Dimensions

Female Hubbell Connectors

Aluminum Inches (cm)

F	A	B	C	D	E	E	
N.P.T.	Form	Dia.	Ref	Throat Dia.	Across Corners	Across Flats	
3/8-18	1	.88" (2.24)	1.40" (3.56)	.560" (1.42)	.44" (1.12)	.94" (2.39)	.81" (2.06)
1/2-14	2	1.13" (2.87)	1.80" (4.57)	.560" (1.42)	.63" (1.60)	1.15" (2.92)	1.00" (2.54)
3/4-14	2	1.13" (2.87)	2.10" (5.33)	.750" (1.90)	.63" (1.60)	1.44" (3.66)	1.25" (3.17)
1-11½	4	1.75" (4.44)	2.30" (5.84)	.880" (2.24)	1.10" (2.79)	1.88" (4.78)	1.63" (4.14)
1¼-11½	5	2.31" (5.87)	2.80" (7.11)	.950" (2.41)	1.43" (3.63)	2.64" (6.71)	2.29" (5.82)
1½-11½	5	2.31" (5.87)	2.80" (7.11)	.950" (2.41)	1.43" (3.63)	2.64" (6.71)	2.29" (5.82)

Product Data

Dust-Tight Strain Relief Grips for Insulated Cables

Kellems Strain Relief Grips connect flexible cord or bus drop cable to electrical enclosures. For indoor use only, they are available with either insulated or non-insulated aluminum fittings, and feature single weave, galvanized steel mesh grips with patented wide range mesh construction. They come with a locknut and a neoprene gasket that provides a dust tight seal.

Application

Used to connect electrical cable to power boxes, cabinets, panel boards, power centers, machine tools and with bus drop systems.

Benefits

- Helps prevent cord or cable pull-out.
- Provides a dust tight seal.
- Easy installation.
- Patented mesh construction.
- One piece design.

I-Grips for Insulated Cables

Kellems I-Grips are made of high strength, plastic coated galvanized steel strand. They are offered in six sizes to fit all cable diameters used with Hubbell Insulgrip®. Kellems I-Grips will control cable arc-of-bend and reduce high pull tensions from being transmitted to the wiring terminals.

Application

Kellems I-Grips will fit 2, 3, 4 and 5 wire Hubbell Insulgrip plugs and connector bodies. The eye tabs fit under the nylon cord clamp and the screws slide through the eyelets, securing the grip in place.

I-Grips can be used on any Insulgrip cord set which requires cable, arc-of-bend control or heavy duty strain relief. Cord sets used at in-door construction sites or for plant maintenance jobs are examples.

These grips are for indoor use only.

Benefits

- Easily attached to Insulgrip plugs and connector bodies.
- Fits all sizes.
- Provides heavy duty strain relief.
- Controls cable arc-of-bend.

Note: I-Grips should not be used on Insulgrip devices when "Seal-Tite®" weatherproof covers are to be installed.

Dimensions shown are approximate and are subject to change without notice.



Strain Relief Grips for Liquidtight Flexible Metal and PolyTuff I Non-Metallic Conduit

Kellems Liquidtight, Flexible Metal Conduit Grips are offered with high quality Hubbell plated steel fittings in a wide variety of N.P.T. sizes and configurations, either insulated or non-insulated. The addition of a stainless steel mesh to these fittings makes them stronger than the conduit itself. Kellems Conduit Grips helps prevent conduit pull-out from the connecting fitting that is subject to stress, pull tension, vibration, motion or strain. They promote safe electrical systems and reduce equipment downtime.

Application

Kellems Conduit Grips are used in the wiring of machine tools, motors, molding equipment, transformers, weaving and paper machines, fans, lighting, bakeries, breweries, food processing, chemical plants, dairies, mines and any application that requires Liquidtight Conduit.

Benefits

- Helps prevent conduit pull-out and damage at the fitting.
- Reduces equipment downtime.
- Liquidtight fittings.
- Easily installed.
- Stainless steel grip resists corrosion.

Kellems Conduit Grips are suitable for use in hazardous locations per Class I Div. 2, Class II Div. 1 & 2, Class III Div. 1 & 2 of the National Electric Code.

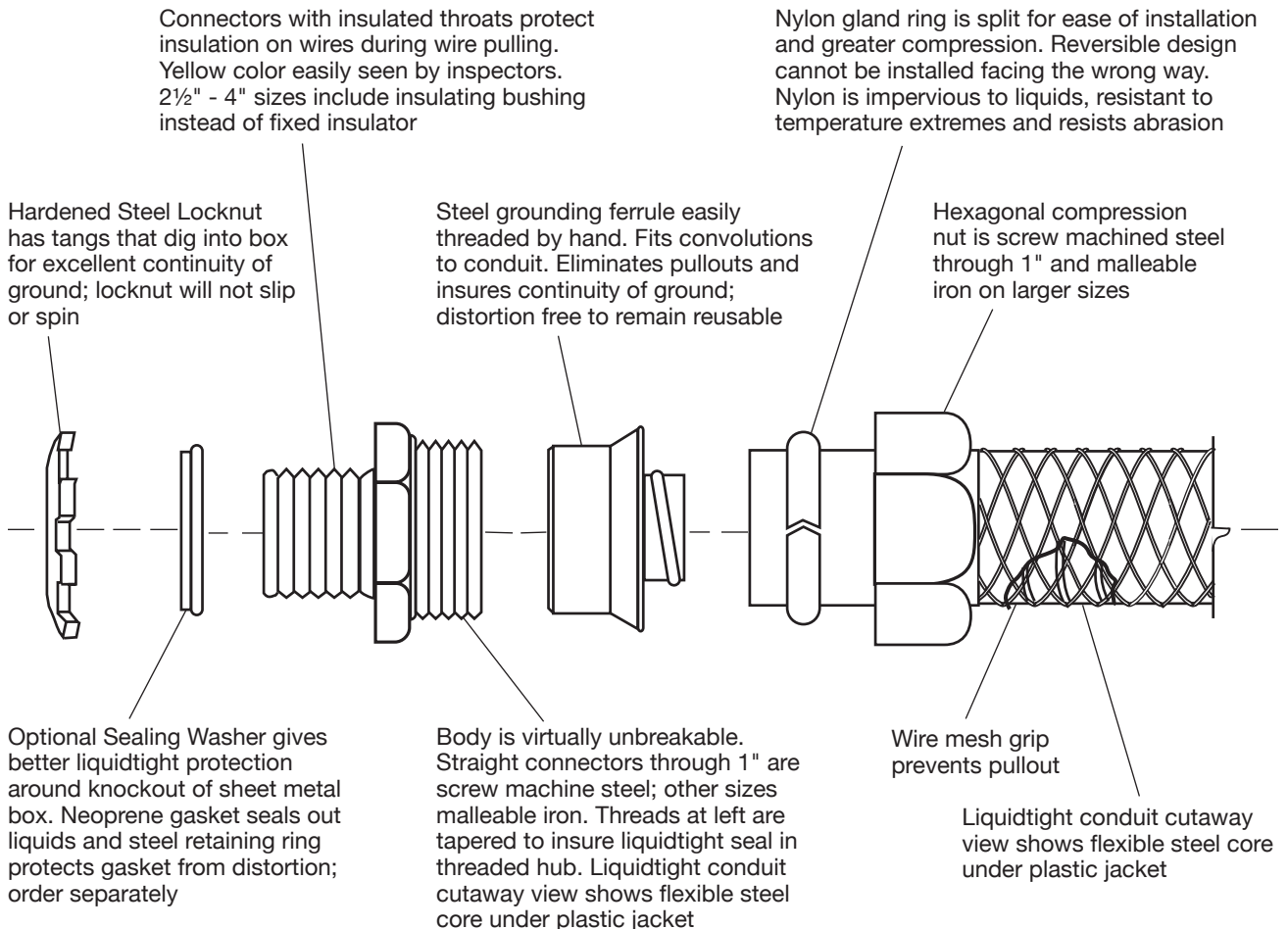



Kellems® Wire Management Products

Technical Information*Strain Relief for Liquidtight Conduit***Strain Relief for UL Type A, Flexible, Liquidtight Conduit**

Kellems Grips for UL Type A, non-metallic, flexible, liquidtight conduit are available in straight and 90° male and feature a high quality Hubbell plated steel or malleable iron fitting, complete with a sealing O-ring, lock nut and stainless steel mesh. These grips increase the retention of the conduit in the fitting, control its arc-of-bend and provide a liquidtight seal.

Application

These grips are used on UL Type A non-metallic conduit connections at limit switches, motor boxes, panel boards, control stations and on all types of machinery and machine tools.

Benefits

- Provides a liquidtight seal.
- Helps prevent conduit pull-out.
- Reduces conduit cutting, kinking, fraying and splitting at the fitting.
- Easily installed.

Steel Locknut has tangs that dig into box for excellent continuity of ground; locknut will not slip or spin

Neoprene O-ring is factory assembled into the body to seal out liquids

Body is virtually unbreakable. Straight connectors through 1" are screw machine steel; other sizes are malleable iron. Threads are tapered to insure liquidtight seal when used in threaded hub; octagonal shape inside holds the ferrule to prevent conduit from twisting during installation

Wire mesh grip prevents pullout

Insulated throat protects insulation on wires during pulling; yellow color easily seen by inspectors

Yellow nylon ferrule fits inside non-metallic conduit to hold the shape; barb in designed to assure liquidtight seal even with non-square cut; ferrule is keyed to fit into body to prevent conduit twisting

Hexagonal compression nut is machine steel through 1" malleable iron on larger sizes; tapered interior compresses sleeve over conduit sealing out liquids and preventing pullout

Yellow nylon sleeve installs over conduit; six slits in sleeve permit tight compression onto conduit as compression nut is tightened

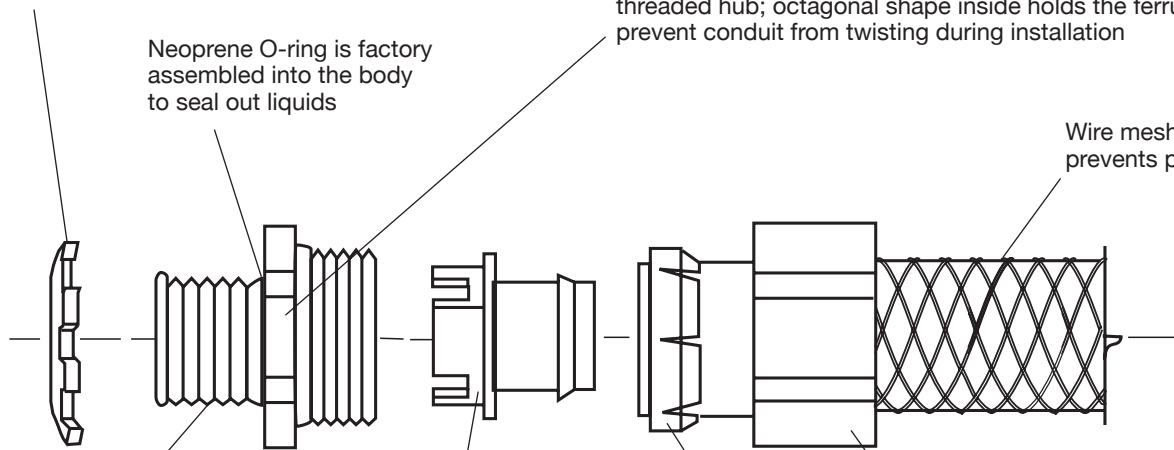



Liquidtight Conduit Grip Fitting Dimensions-Inches

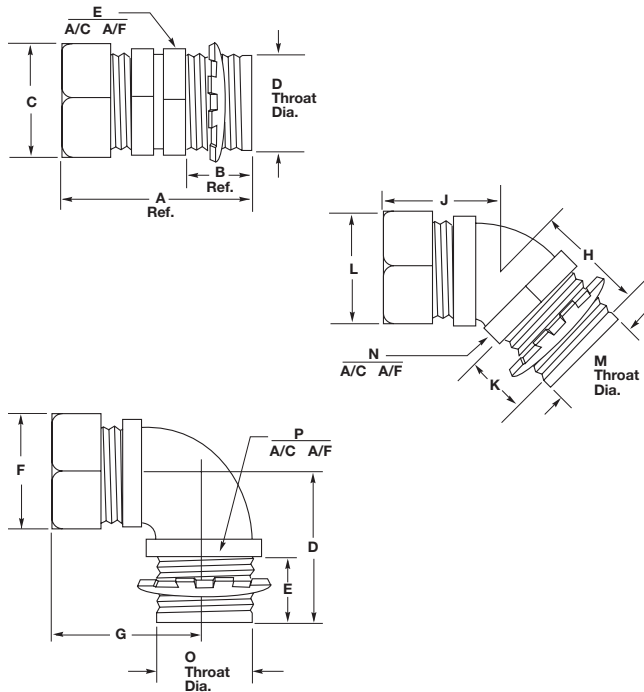

45° Angle with Male Fitting

Dimensions

Trade Size	H	J Ref.	K	L A/C*	A/F*	M Throat Dia.	N A/C*	A/F*	Catalog Number
3/8	1.19"	1.28"	.59"	1.20"	1.06"	.60"	1.16"	1.02"	074093441
1/2	1.19"	1.28"	.59"	1.34"	1.19"	.61"	1.21"	1.06"	074093442
3/4	1.19"	1.43"	.59"	1.55"	1.45"	.84"	1.50"	1.32"	074093443
1	1.38"	1.53"	.66"	1.95"	1.69"	1.05"	1.82"	1.59"	074093444
1 1/4	1.42"	1.69"	.63"	2.39"	2.06"	1.37"	2.32"	2.03"	074093445
1 1/2	1.66"	2.00"	.66"	2.72"	2.38"	1.60"	2.62"	2.29"	074093446
2	1.69"	2.25"	.66"	3.08"	2.88"	2.05"	3.21"	2.80"	074093448

45° Angle with Male Fitting with Insulated Throat

Dimensions

Trade Size	H	J Ref.	K	L A/C*	A/F*	M Throat Dia.	N A/C*	A/F*	Catalog Number
3/8	1.25"	1.28"	.66"	1.20"	1.06"	.57"	1.16"	1.02"	074093561
1/2	1.25"	1.28"	.66"	1.34"	1.19"	.57"	1.21"	1.06"	074093562
3/4	1.25"	1.44"	.66"	1.55"	1.45"	.78"	1.50"	1.32"	074093563
1	1.44"	1.53"	.72"	1.95"	1.69"	.98"	1.82"	1.59"	074093564
1 1/4	1.48"	1.69"	.69"	2.39"	2.06"	1.29"	2.32"	2.03"	074093565
1 1/2	1.72"	2.00"	.72"	2.72"	2.38"	1.53"	2.62"	2.29"	074093566
2	1.75"	2.25"	.72"	3.08"	2.87"	1.95"	3.21"	2.80"	074093568

Straight with Male Fitting

Dimensions

Trade Size	A Ref.	B	C A/C*	A/F*	D Throat Dia.	E A/C*	A/F*	Catalog Number
3/8	1.43"	.59"	1.20"	1.06"	.61"	1.07"	.93"	074093401
1/2	1.43"	.59"	1.34"	1.19"	.61"	1.22"	1.06"	074093402
3/4	1.56"	.59"	1.55"	1.37"	.84"	1.43"	1.25"	074093403
1	1.68"	.66"	1.95"	1.69"	1.06"	1.73"	1.56"	074093404
1 1/4	2.03"	.63"	2.39"	2.06"	1.37"	2.36"	2.08"	074093405
1 1/2	2.21"	.63"	2.72"	2.38"	1.53"	2.79"	2.48"	074093406
2	2.28"	.69"	3.08"	2.87"	2.06"	3.32"	2.90"	074093408

90° Angle with Male Fitting

Dimensions

Trade Size	D	E	F A/C*	A/F*	G Ref.	O Throat Dia.	P A/C*	A/F*	Catalog Number
3/8	1.31"	.59"	1.20"	1.06"	1.44"	.60"	1.13"	.99"	074093421
1/2	1.31"	.59"	1.34"	1.12"	1.44"	.61"	1.21"	1.00"	074093422
3/4	1.44"	.59"	1.55"	1.45"	1.63"	.83"	1.48"	1.29"	074093423
1	1.78"	.66"	1.95"	1.60"	2.19"	1.05"	1.80"	1.57"	074093424
1 1/4	1.97"	.63"	2.39"	2.06"	2.50"	1.37"	2.32"	2.02"	074093425
1 1/2	2.19"	.66"	2.72"	2.38"	2.69"	1.61"	2.58"	2.25"	074093426
2	2.53"	.66"	3.08"	2.87"	3.25"	2.05"	3.14"	2.75"	074093428

Straight with Male Fitting with Insulated Throat

Dimensions

Trade Size	A Ref.	B	C A/C*	A/F*	D Throat Dia.	E A/C*	A/F*	Catalog Number
3/8	1.50"	.66"	1.20"	1.06"	.57"	1.07"	.93"	074093511
1/2	1.50"	.66"	1.34"	1.19"	.57"	1.22"	1.06"	074093512
3/4	1.62"	.66"	1.55"	1.38"	.78"	1.43"	1.25"	074093513
1	1.75"	.72"	1.95"	1.69"	.98"	1.73"	1.56"	074093514
1 1/4	2.09"	.69"	2.39"	2.06"	1.29"	2.36"	2.08"	074093515
1 1/2	2.28"	.69"	2.72"	2.37"	1.53"	2.79"	2.48"	074093516
2	2.34"	.75"	3.08"	2.87"	1.95"	3.32"	2.90"	074093518
2 1/2	3.56"	1.06"	3.92"	3.62"	2.42"	3.85"	3.60"	074093520
3	3.81"	1.06"	4.70"	4.31"	3.01"	4.65"	4.33"	074093522
4	3.81"	1.06"	5.75"	5.31"	3.96"	5.75"	5.39"	074093526

90° Angle with Male Fitting with Insulated Throat

Dimensions

Trade Size	D	E	F A/C*	A/F*	G Ref.	O Throat Dia.	P A/C*	A/F*	Catalog Number
3/8	1.38"	.66"	1.20"	1.06"	1.44"	.60"	1.13"	.99"	074093541
1/2	1.38"	.66"	1.34"	1.12"	1.44"	.57"	1.21"	1.00"	074093542
3/4	1.50"	.66"	1.55"	1.45"	1.63"	.78"	1.48"	1.29"	074093543
1	1.84"	.66"	1.95"	1.60"	2.19"	.98"	1.80"	1.57"	074093544
1 1/4	2.03"	.69"	2.39"	2.06"	2.50"	1.29"	2.32"	2.02"	074093545
1 1/2	2.25"	.69"	2.72"	2.38"	2.69"	1.53"	2.58"	2.20"	074093546
2	2.59"	.72"	3.08"	2.87"	3.25"	1.95"	3.14"	2.75"	074093548
2 1/2	3.44"	1.00"	3.92"	3.63"	4.25"	2.42"	3.78"	3.50"	074093550
3	3.75"	1.00"	4.70"	4.31"	4.87"	3.01"	4.64"	4.30"	074093552

Note: *A/C - Across Corners; A/F - Across Flats.

Dimensions shown are approximate and are subject to change without notice.





Kellems® Wire Management Products

Technical Information

Strain Relief for Liquidtight Conduit

Dimensional Charts For UL Type A, Liquidtight Conduit Grip Fittings

Straight with Male Fitting with Insulated Throat

Dimensions Inches (cm)

Trade Size N.P.T. Inches	A	B	C	D	Catalog Number
3/8	1.922" (4.88)	.594" (1.51)	1.156" (2.94)	3.75" (9.52)	H038CNK
1/2	1.922" (4.88)	.594" (1.51)	1.250" (3.17)	4.50" (11.43)	H050CNK
3/4	2.016" (5.12)	.594" (1.51)	1.500" (3.81)	6.25" (15.87)	H075CNK
1	2.157" (5.48)	.719" (1.83)	1.844" (4.68)	7.50" (19.05)	H100CNK
1 1/4	2.219" (5.64)	.750" (1.91)	2.312" (5.87)	9.00" (22.86)	H125CNK
1 1/2	2.344" (5.95)	.750" (1.91)	2.578" (6.55)	13.50" (34.29)	H150CNK
2	2.406" (6.11)	.750" (1.91)	3.187" (8.09)	14.50" (36.83)	H200CNK

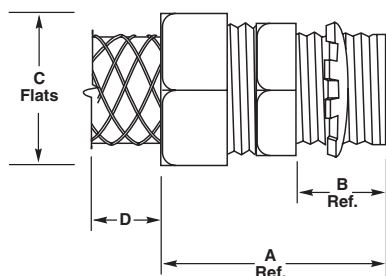

90° Angle with Male Fitting with Insulated Throat

Dimensions Inches (cm)

Trade Size N.P.T. Inches	E	F	G	H	I	Catalog Number
3/8	1.250" (3.18)	.594" (1.51)	1.156" (2.94)	1.453" (3.69)	3.75" (9.52)	H0389CNK
1/2	1.281" (3.25)	.594" (1.51)	1.250" (3.17)	1.453" (3.69)	4.50" (11.43)	H0509CNK
3/4	1.438" (3.65)	.594" (1.51)	1.500" (3.81)	1.000" (2.54)	6.25" (15.87)	H0759CNK
1	1.750" (4.44)	.719" (1.83)	1.844" (4.68)	2.125" (5.40)	7.50" (19.05)	H1009CNK
1 1/4	1.969" (5.00)	.750" (1.91)	2.312" (5.87)	2.344" (5.95)	9.00" (22.86)	H1259CNK
1 1/2	2.250" (5.71)	.750" (1.91)	2.578" (6.55)	2.500" (6.35)	13.50" (34.29)	H1509CNK
2	2.531" (6.43)	.750" (1.91)	3.187" (8.09)	2.781" (7.06)	14.50" (36.83)	H2009CNK

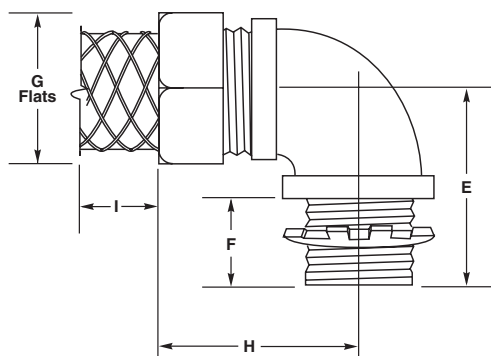

Dimensions shown are approximate and are subject to change without notice.

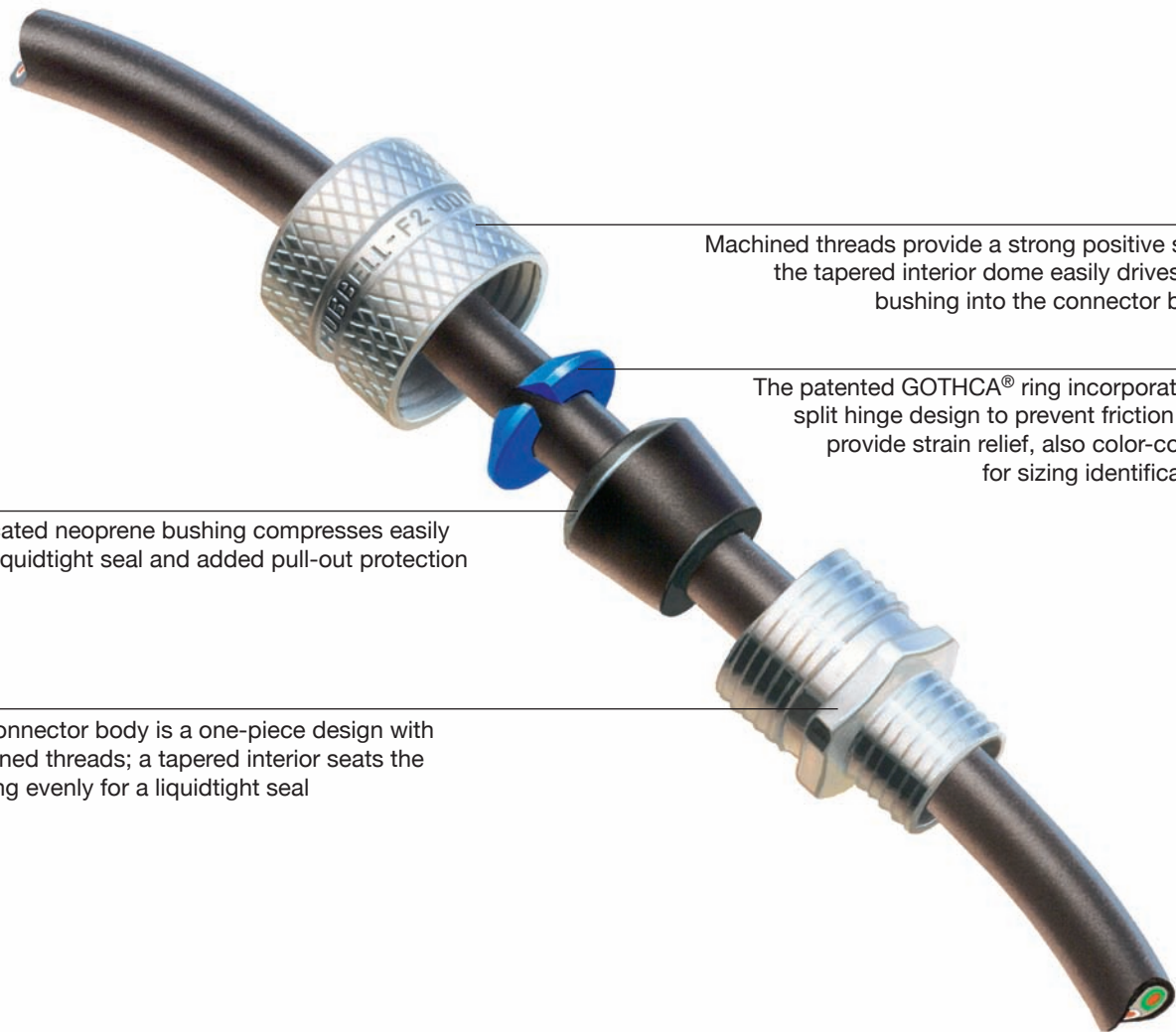

Machined threads provide a strong positive seal; the tapered interior dome easily drives the bushing into the connector body

The patented GOTHCA® ring incorporates a split hinge design to prevent friction and provide strain relief, also color-coded for sizing identification

Lubricated neoprene bushing compresses easily for a liquidtight seal and added pull-out protection

The connector body is a one-piece design with machined threads; a tapered interior seats the bushing evenly for a liquidtight seal

Hubbell has the broadest line and the widest choice of materials in the industry. N.P.T. hub sizes from ¼" to 3" in straight male end, 90°, 45°, female and underground feed connectors. They are available in your choice of aluminum, plated steel, nylon and stainless steel.

Hubbell offers a full line of machined aluminum cord connectors in N.P.T. hub sizes ¼" through 1" and cast aluminum 1" to 3". They provide durable performance and a clean attractive look without adding unwanted weight. N.P.T. hub sizes ¼" to 1" feature an attractive knurled finish which makes them easy to handle and maintain a U.L. listing by hand tightening.

The zinc-plated steel cord connectors offers the strength of steel and the corrosion resistance of zinc-plating. These heavy-duty connectors hold up to most manufacturing chemicals including acid solutions, solvents and other corrosive materials.

Their machined steel nut and body allows for tightening the compression nut and N.P.T. hub without worrying about stripping the threads. For larger size cord, N.P.T. hub sizes 1" to 2", Hubbell utilizes malleable iron connectors which provide excellent holding and liquidtight performance.

Hubbell's nylon cord connectors resist most common industrial corrosives and provide highly effective pullout protection in a lightweight design. They are ideal for any application where weight, conductivity or corrosion may be an issue. They're available in N.P.T. hub sizes from ¼" to 1".

Stainless steel cord connectors provide superior strength and corrosion resistance for industrial and military applications. They are machined from 300 series stainless steel and come in ¼" to 1", N.P.T. hub sizes.

Kellems® Wire Management Products Straight Male Cord Connectors

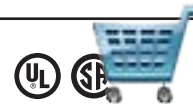

Form Size 1-3



UL Listed to Type 4,
4X, 12 and Type 13

IP66*
SUITABILITY

Straight Male

N.P.T. Hub Size	Cord Dia. Inches (mm)	Form Size	Color Code	Machined Aluminum	Machined Zinc-Plated Steel	Stainless Steel	Nylon Gray	Nylon Black
 Machined Aluminum	.06"-.13" (1.6-3.2)	F1	Green	—	—	—	SHC1001CR	—
	.13"-.19" (3.2-4.7)		Orange	SHC1002	—	—	SHC1002CR	—
	.19"-.25" (4.7-6.3)		Red	SHC1003	—	SHC1003SS	SHC1003CR	—
	.25"-.31" (6.3-7.9)		Black	SHC1004	—	SHC1004SS	SHC1004CR	—
	.31"-.38" (7.9-9.5)		White	SHC1005**	—	—	SHC1005CR	SHC2005CR
	.38"-.44" (9.5-11)		Blue	—	—	—	SHC1006CR	—
	 Machined Zinc-Plated Steel		.06"-.13" (1.6-3.2)	F1	Green	SHC1007	—	—
.13"-.19" (3.2-4.7)		Orange	SHC1008		SHC1008ZP	—	SHC1008CR	SHC2008CR
.19"-.25" (4.7-6.3)		Red	SHC1009		—	SHC1009SS	SHC1009CR	—
.25"-.31" (6.3-7.9)		Black	SHC1010		SHC1010ZP	—	SHC1010CR	SHC2010CR
.31"-.38" (7.9-9.5)		White	SHC1011		—	SHC1011SS	SHC1011CR	SHC2011CR
.38"-.44" (9.5-11.0)		Blue	SHC1012		SHC1012ZP	SHC1012SS	SHC1012CR	SHC2012CR
1/2		.19"-.25" (4.7-6.3)	F1		Red	SHC1015	—	—
	.25"-.31" (6.3-7.9)	Black		SHC1016	—	—	—	—
	.31"-.38" (7.9-9.5)	White		SHC1017	—	—	—	—
	.38"-.44" (9.5-11.0)	Blue		SHC1018	—	—	—	—
1/2	.06"-.13" (1.6-3.2)	F2	Green	SHC1019	—	—	SHC1019CR	—
	.13"-.19" (3.2-4.7)		Orange	SHC1020	SHC1020ZP	SHC1020SS	SHC1020CR	—
	.19"-.25" (4.7-6.3)		Red	SHC1021	SHC1021ZP	SHC1021SS	SHC1021CR	SHC2021CR
	.25"-.38" (6.3-9.7)		White	SHC1022	SHC1022ZP	SHC1022SS	SHC1022CR	SHC2022CR
	.38"-.50" (9.7-12.7)		Blue	SHC1023	SHC1023ZP	SHC1023SS	SHC1023CR	SHC2023CR
	.50"-.63" (12.7-15.9)		Brown	SHC1024	SHC1024ZP	SHC1024SS	SHC1024CR**	SHC2024CR**
	.38"-.50" (9.7-12.7)		Blue	SHC1025	—	—	—	—
1/2	.50"-.63" (12.7-15.9)	F3	Brown	SHC1026	—	—	—	—
	.63"-.75" (15.9-19.0)		Yellow	SHC1027**	SHC1027ZP**	—	—	—
	.75"-.88" (19.0-22.2)		Orchid	SHC1028**	SHC1028ZP**	—	—	—

Note: See pages T-92 to T-101 for additional technical data and dimensional drawings.

* IP66 Suitability when used with optional metal clad O-ring shown on page T-89.

** Cable jacket may have to be stripped to pass through connector body.

Locknuts sold separately. See page T-89.

Kellems® Wire Management Products

Straight Male Cord Connectors

Form Size 2-4



UL Listed to Type 4,
4X, 12 and Type 13

IP66*
SUITABILITY

Straight Male

N.P.T. Hub Size	Cord Dia. Inches (mm)	Form Size	Color Code	Machined Aluminum	Machined Zinc-Plated Steel	Stainless Steel	Nylon Gray	Nylon Black
¾	.06"-.13" (1.6-3.2)	F2	Green	SHC1029	—	—	—	—
	.13"-.19" (3.2-4.7)		Orange	SHC1030	SHC1030ZP	—	—	—
	.19"-.25" (4.7-6.3)		Red	SHC1031	SHC1031ZP	—	—	—
	.25"-.38" (6.3-9.7)		White	SHC1032	SHC1032ZP	—	—	—
	.38"-.50" (9.7-12.7)		Blue	SHC1033	SHC1033ZP	—	—	—
	.50"-.63" (12.7-15.9)		Brown	SHC1034	SHC1034ZP	—	—	—
¾	.38"-.50" (9.5-12.7)	F3	Blue	—	SHC1035ZP	SHC1035SS	SHC1035CR	SHC2035CR
	.50"-.63" (12.7-15.9)		Brown	SHC1036	—	SHC1036SS	SHC1036CR	SHC2036CR
	.63"-.75" (15.9-19.0)		Yellow	SHC1037	SHC1037ZP	SHC1037SS	SHC1037CR	SHC2037CR
	.75"-.88" (19.0-22.2)		Orchid	SHC1038**	SHC1038ZP**	SHC1038SS**	SHC1038CR**	SHC2038CR**
1	.50"-.63" (12.7-15.9)	F3	Brown	—	SHC1097ZP	—	—	—
	.63"-.75" (15.9-19.0)		Yellow	—	SHC1098ZP	—	—	—
	.75"-.88" (19.0-22.2)		Orchid	—	SHC1099ZP	—	—	—
1	.38"-.50" (9.7-12.7)	F4	Blue	SHC1039	—	—	SHC1039CR	—
	.50"-.63" (12.7-15.9)		Brown	SHC1040	—	—	SHC1040CR	SHC2040CR
	.63"-.75" (15.9-19.0)		Yellow	SHC1041	—	SHC1041SS	SHC1041CR	SHC2041CR
	.75"-.88" (19.0-22.2)		Orchid	SHC1042	—	SHC1042SS	SHC1042CR	SHC2042CR
	.88"-.1.00" (22.2-25.4)		Gray	SHC1043	SHC1043ZP	—	SHC1043CR	SHC2043CR
	1.00"-.1.13" (25.4-28.6)		Pink	SHC1044**	—	SHC1044SS**	SHC1044CR**	SHC2044CR**



Stainless Steel



Gray Nylon



Black Nylon

Note: See pages T-92 to T-101 for additional technical data and dimensional drawings.

* IP66 Suitability when used with optional metal clad O-ring shown on page T-89.

** Cable jacket may have to be stripped to pass through connector body.

Form 4 aluminum and plated steel nuts are machined, bodies are cast aluminum.

Locknuts sold separately. See page T-89.

Kellems® Wire Management Products Straight Male Cord Connectors

Form Size 5-8

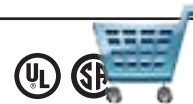

UL Listed to Type 4,
4X, 12 and Type 13

IP66*
SUITABILITY

Straight Male

N.P.T. Hub Size	Cord Diameter		Form Size	Cast Aluminum	Malleable Iron
	Inches	(mm)			
1	.88"-1.00"	(22.2-25.4)	F5	SHC1046	—
	1.00"-1.13"	(25.4-28.6)		SHC1047**	—
	1.13"-1.25"	(28.6-31.7)		SHC1048**	—
	1.25"-1.38"	(31.7-34.9)		SHC1049**	—
1¼	.75"-.88"	(19.0-22.2)	F5	SHC1050	—
	.88"-1.00"	(22.2-25.4)		SHC1051	—
	1.00"-1.13"	(25.4-28.6)		SHC1052	SHC1052ZP
	1.13"-1.25"	(28.6-31.7)		SHC1053	SHC1053ZP
1½	1.25"-1.38"	(31.7-34.9)	F5	SHC1054**	SHC1054ZP
	.75"-.88"	(19.0-22.2)		SHC1055	—
	.88"-1.00"	(22.2-25.4)		SHC1056	—
	1.00"-1.13"	(25.4-28.6)		SHC1057	SHC1057ZP
1½	1.13"-1.25"	(28.6-31.7)	F5	SHC1058	SHC1058ZP
	1.25"-1.38"	(31.7-34.9)		SHC1059	SHC1059ZP
	1.38"-1.50"	(34.9-38.1)		SHC1061	—
	1.50"-1.63"	(38.1-41.3)		SHC1062**	—
1½	1.63"-1.75"	(41.3-44.4)	F6	SHC1063**	—
	1.75"-1.88"	(44.4-47.6)		SHC1064**	—
	1.25"-1.38"	(31.7-34.9)		SHC1065	—
	1.38"-1.50"	(34.9-38.1)		SHC1066	—
2	1.50"-1.63"	(38.1-41.3)	F6	SHC1067	—
	1.63"-1.75"	(41.3-44.4)		SHC1068	—
	1.75"-1.88"	(44.4-47.6)		SHC1069	—
	1.69"-1.81"	(42.9-46.0)		SHC1070	—
2	1.81"-1.94"	(46.0-49.2)	F7	SHC1071	—
	1.94"-2.06"	(49.2-52.4)		SHC1072**	—
	2.06"-2.19"	(52.4-55.6)		SHC1073**	—
	2.19"-2.31"	(55.6-58.7)		SHC1074**	—
2½	1.69"-1.81"	(42.9-46.0)	F7	SHC1076	—
	1.81"-1.94"	(46.0-49.2)		SHC1077	—
	1.94"-2.06"	(49.2-52.4)		SHC1078	—
	2.06"-2.19"	(52.4-55.6)		SHC1079	—
2	2.19"-2.31"	(55.6-58.7)	F7	SHC1080	—
	2.31"-2.44"	(58.7-61.9)		SHC1081**	—
	1.69"-1.81"	(42.9-46.0)		SHC1086	—
	1.94"-2.06"	(49.2-52.4)		SHC1088	—
3	2.06"-2.19"	(52.4-55.6)	F7	SHC1089	—
	2.19"-2.31"	(55.6-58.7)		SHC1090	—
	2.31"-2.44"	(58.7-61.9)		SHC1091	—
	2.44"-2.63"	(61.9-66.7)		SHC1092	—
3	2.63"-2.81"	(66.7-71.4)	F8	SHC1093	—
	2.81"-3.00"	(71.4-76.2)		SHC1094	—
	3.00"-3.25"	(76.2-82.5)		SHC1095**	—

Note: See pages T-92 to T-101 for additional technical data and dimensional drawings.
 * IP66 Suitability when used with optional metal clad O-ring shown on page T-89.
 ** Cable jacket may have to be stripped to pass through connector body.
 Form 4 aluminum and plated steel nuts are machined, bodies are cast aluminum.
 F5 and larger will not be color coded.
 Locknuts sold separately. See page T-89.



Cast Aluminum



Cast Aluminum
Malleable Iron

Kellems® Wire Management Products

45° Male Cord Connectors

Form Size 2-5



UL Listed to Type 4,
4X, 12 and Type 13

IP66*
SUITABILITY

45° Male

N.P.T. Hub Size	Cord Diameter		Form Size	Color Code	Machined Machined Aluminum†	Zinc-Plated Steel ^Δ	Cast Aluminum
	Inches	(mm)					
½	.19"-.25"	(4.7-6.3)	F2	Red	VHC1021	—	—
	.25"-.38"	(6.3-9.7)		White	VHC1022	VHC1022ZP	—
	.38"-.50"	(9.7-12.7)		Blue	VHC1023	VHC1023ZP	—
	.50"-.63"	(12.7-15.9)		Brown	VHC1024**	VHC1024ZP**	—
¾	.38"-.50"	(9.7-12.7)	F3	Blue	VHC1035	—	—
	.50"-.63"	(12.7-15.9)		Brown	VHC1036	—	—
	.63"-.75"	(15.9-19.0)		Yellow	VHC1037**	—	—
1	.63"-.75"	(15.9-19.0)	F4	Yellow	VHC1041	—	—
	.75"-.88"	(19.0-22.2)		Orchid	VHC1042	—	—
1¼	1.00"-1.13"	(25.4-28.6)	F5		—	—	VHC1052
	1.13"-1.25"	(28.6-31.7)			—	—	VHC1053**

Note: See pages T-92 to T-101 for additional technical data and dimensional drawings.

* IP66 Suitability when used with optional metal clad O-ring shown on page T-89.

** Cable jacket may have to be stripped to pass through connector body.

Form 4 aluminum and plated steel nuts are machined, bodies are cast aluminum.

† Nuts are machined aluminum and bodies are cast aluminum.

Δ Nuts are machined zinc-plated steel and bodies are malleable iron, cadmium plated.

Locknuts sold separately. See page T-89.



**Machined
Aluminum †**



**Machined
Zinc-Plated Steel Δ**



Cast Aluminum

Kellems® Wire Management Products

90° Male Cord Connectors

Form Size 1-6



UL Listed to Type 4,
4X, 12 and Type 13

IP66*
SUITABILITY



90° Male

N.P.T. Hub Size	Cord Diameter Inches (mm)	Form Size	Color Code	Machined Aluminum†	Machined Zinc-Plated Steel ^Δ	Nylon Gray	Nylon Black	Cast Aluminum
3/8	.25"-.31" (6.3-7.9)	F1	Black	NHC1010	—	—	—	—
	.31"-.38" (7.9-9.5)		White	NHC1011	—	—	—	—
	.38"-.44" (9.5-11.0)		Blue	NHC1012	—	—	—	—
1/2	.06"-.13" (1.6-3.2)	F2	Green	—	—	—	—	—
	.13"-.19" (3.2-4.7)		Orange	NHC1020	—	NHC1020CR	—	—
	.19"-.25" (4.7-6.3)		Red	NHC1021	NHC1021ZP	NHC1021CR	—	—
	.25"-.38" (6.3-9.7)		White	NHC1022	NHC1022ZP	NHC1022CR	NHC2022CR	—
	.38"-.50" (9.7-12.7)		Blue	NHC1023	NHC1023ZP	NHC1023CR	NHC2023CR	—
	.50"-.63" (12.7-15.9)		Brown	NHC1024**	NHC1024ZP**	NHC1024CR**	NHC2024CR**	—
3/4	.38"-.50" (9.7-12.7)	F3	Blue	NHC1035	NHC1035ZP	NHC1035CR	—	—
	.50"-.63" (12.7-15.9)		Brown	NHC1036	NHC1036ZP	NHC1036CR	—	—
	.63"-.75" (15.9-19.0)		Yellow	NHC1037	NHC1037ZP	NHC1037CR	—	—
	.75"-.88" (19.0-22.2)		Orchid	NHC1038	NHC1038ZP	NHC1038CR	—	—
1	.50"-.63" (12.7-15.9)	F4	Brown	NHC1040	—	—	—	—
	.63"-.75" (15.9-19.0)		Yellow	NHC1041	NHC1041ZP	NHC1041CR	NHC2041CR	—
	.75"-.88" (19.0-22.2)		Orchid	NHC1042	—	NHC1042CR	NHC2042CR**	—
	.88"-1.00" (22.2-25.4)		Gray	NHC1043**	—	NHC1043CR	NHC2043CR**	—
	1.00"-1.13" (25.4-28.7)		Pink	NHC1044**	—	—	—	—
1 1/4	.88"-1.00" (22.2-25.4)	F5	—	—	—	—	—	NHC1051
	1.00"-1.13" (25.4-28.6)		—	—	—	—	—	NHC1052
	1.13"-1.25" (28.6-31.7)		—	—	—	—	—	NHC1053**
	1.25"-1.38" (31.7-34.9)		—	—	—	—	—	NHC1054**
1 1/2	1.00"-1.13" (25.4-28.6)	F5	—	—	—	—	—	NHC1057
	1.13"-1.25" (28.6-31.7)		—	—	—	—	—	—
	1.25"-1.38" (31.7-34.9)		—	—	—	—	—	NHC1059
2	1.38"-1.50" (34.9-38.1)	F6	—	—	—	—	NHC1066	

Note: See pages T-92 to T-101 for additional technical data and dimensional drawings.

* IP66 Suitability when used with optional metal clad O-ring shown on page T-89.

** Cable jacket may have to be stripped to pass through connector body.

† Nuts are machined aluminum and bodies are cast aluminum.

Δ Compression nuts are machined zinc-plated steel and bodies are zinc-plated malleable iron. Locknuts sold separately. See page T-89.



Machined Aluminum†



Machined Zinc-Plated Steel^Δ



Gray Nylon



Black Nylon



Cast Aluminum

Kellems® Wire Management Products

Straight Female, Underground Feeder and Metric Connectors

Form Size 1-4



Straight Female

N.P.T. Hub Size	Cord Diameter Inches (mm)	Form Size	Color Code	Machined Aluminum
1/2	.25"-.38" (6.3-9.7)	F2	White	FHC1022
	.38"-.50" (9.7-12.7)		Blue	FHC1023
3/4	.38"-.50" (9.7-12.7)	F2	Blue	FHC1033
	.50"-.63" (12.7-15.9)		Brown	FHC1034
1	.75"-.88" (19.0-22.2)	F4	Orchid	FHC1042†
	.88"-1.00" (22.2-25.4)		Gray	FHC1043†

Note: See pages T-92 to T-101 for additional technical data and dimensional drawings.
 * Cable jacket may have to be stripped to pass through connector body.
 † Nuts are machined aluminum and bodies are cast aluminum.



Machined Aluminum



Underground Feeder Connectors

IP66*
SUITABILITY

N.P.T. Hub Size	Diameter Inches (mm)	Wire Size	UF** Machined Aluminum	Zinc-Plated Steel	Machined Nylon Gray	Nylon Black
1/2	.2"x.4" min (5.1 x 10.2)	2 # 14,	UFC0001	UFC0001ZP	UFC0001CR	UFC2001CR
	.25"-.55" max (6.3 x 14.0)	2 # 12, 2 # 10.				
3/4	.2"x.4" min (5.1x10.2)	2 # 14,	UFC0002	-	-	-
	.25"-.55" max (6.3x14.0)	2 # 12, 2 # 10.				
3/4	.2"x.6" min (5.1x15.2)	3 # 14,	UFC0003	-	UFC0003CR	UFC2003CR
	.26"x.78" max (6.6x19.8)	3 # 12, 3 # 10.				

Note: See pages T-92 to T-101 for additional technical data and dimensional drawings.
 * IP66 Suitability when used with optional metal clad O-ring shown on page T-89.
 ** Wire sizes vary among manufacturers.
 Locknuts sold separately. See page T-89.



Machined Aluminum



Machined Zinc-Plated Steel



UL Listed to Type 4, 4X, 12 and Type 13†

Metric Aluminum Cord Connectors

Hub Size	Cord Diameter Inches (mm)	Form Size	Catalog Number
M16	.31"-.38" (7.9-9.7)	F1	SHCM161011
M20	.31"-.38" (7.9-9.7)	F1	SHCM201017
	.25"-.38" (6.3-9.7)		SHCM201022
M20	.38"-.50" (9.7-12.7)	F2	SHCM201023
	.50"-.62" (12.7-15.8)		SHCM201024
M25	.38"-.50" (9.7-12.7)	F2	SHCM251033
	.50"-.62" (12.7-15.8)		SHCM251034
M30	.63"-.75" (15.9-19.0)	F3	SHCM301037

Note: † When used with metal clad O-ring shown on page T-89.
 Non-metallic Locknuts sold separately. See page T-88.



Gray Nylon



Machined Aluminum



Kellems® Wire Management Products Low Profile N.P.T., PG and Metric Thread Connectors

Non-Metallic Cord Connectors



IP66*
SUITABILITY



SEC100BA

Low Profile N.P.T. Cord Connectors

N.P.T. Hub Size	Inches	Cord Diameter (mm)	Color	Catalog Number	Non-metallic Locknuts
3/8	.18"-.31"	(4.6-7.9)	Gray	SEC38GA*	31622002LPK50
3/8	.18"-.31"	(4.6-7.9)	Black	SEC38BA*	31622002LPK50
1/2	.17"-.45"	(4.3-11.4)	Gray	SEC50GA	31622003LPK50
1/2	.17"-.45"	(4.3-11.4)	Black	SEC50BA	31622003LPK50
3/4	.45"-.71"	(11.4-18.0)	Gray	SEC75GA	31622007LPK50
3/4	.45"-.71"	(11.4-18.0)	Black	SEC75BA	31622007LPK50
1	.59"-1.00"	(15-25.4)	Gray	SEC100GA	31622008LPK50
1	.59"-1.00"	(15-25.4)	Black	SEC100BA	31622008LPK50

Note: See pages T-92 to T-101 for additional technical data and dimensional drawings.
Catalog numbers with "PK50" suffix are bulk packed 50 pieces.



SECP29GA

Low Profile PG^Δ Cord Connectors

Hub Size	Cord Diameter Inches	(mm)	Color	Catalog Number	Non-metallic Locknuts
PG7	.11"-.25"	(2.9-6.4)	Gray	SECP7GA*	LNP7BPK100
PG7	.11"-.25"	(2.9-6.4)	Black	SECP7BA*	LNP7BPK100
PG9	.18"-.31"	(4.6-7.9)	Gray	SECP9GA*	LNP9BPK100
PG9	.18"-.31"	(4.6-7.9)	Black	SECP9BA*	LNP9BPK100
PG11	.23"-.40"	(5.8-10.0)	Gray	SECP11GA*	LNP11BPK100
PG11	.23"-.40"	(5.8-10.0)	Black	SECP11BA*	LNP11BPK100
PG13.5	.17"-.47"	(4.3-11.9)	Gray	SECP13GA	LNP13BPK100
PG13.5	.17"-.47"	(4.3-11.9)	Black	SECP13BA	LNP13BPK100
PG16	.23"-.53"	(5.8-13.5)	Gray	SECP16GA	LNP16BPK100
PG16	.23"-.53"	(5.8-13.5)	Black	SECP16BA	LNP16BPK100
PG21	.45"-.71"	(11.4-17.9)	Gray	SECP21GA	LNP21BPK100
PG21	.45"-.71"	(11.4-17.9)	Black	SECP21BA	LNP21BPK100
PG29	.59"-.99"	(15-25.2)	Gray	SECP29GA	LNP29BPK25
PG29	.59"-.99"	(15-25.2)	Black	SECP29BA	LNP29BPK25
PG36	.88"-1.30"	(22.2-32.0)	Gray	SECP36GA	LNP36BPK25
PG36	.88"-1.30"	(22.2-32.0)	Black	SECP36BA	LNP36BPK25

Low Profile Metric Cord Connectors

Hub Size	Cord Diameter Inches	(mm)	Color	Catalog Number	Non-metallic Locknuts
M12	.12"-.25"	(2.9-6.4)	Gray	SECM12G	LNM12BPK100
M12	.12"-.25"	(2.9-6.4)	Black	SECM12B	LNM12BPK100
M16	.11"-.31"	(2.7-7.9)	Gray	SECM16G	LNM16BPK100
M16	.11"-.31"	(2.7-7.9)	Black	SECM16B	LNM16BPK100
M20	.17"-.45"	(4.3-11.4)	Gray	SECM20G*	LNM20BPK100
M20	.17"-.45"	(4.3-11.4)	Black	SECM20B*	LNM20BPK100
M25	.49"-.71"	(12.3-18.0)	Gray	SECM25G*	LNM25BPK100
M25	.49"-.71"	(12.3-18.0)	Black	SECM25B*	LNM25BPK100
M32	.59"-1.00"	(15.0-25.4)	Gray	SECM32G*	LNM32BPK100
M32	.59"-1.00"	(15.0-25.4)	Black	SECM32B*	LNM32BPK100
M40	.87"-1.30"	(22.0-32.0)	Gray	SECM40G	LNM40BPK100
M40	.87"-1.30"	(22.0-32.0)	Black	SECM40B	LNM40BPK100

Note: See pages T-92 to T-101 for additional technical data and dimensional data.
Catalog numbers above with "PK100" suffix, i.e. **LNP7BPK100**, are bulk packed 100 per carton.
Catalog numbers above with "PK25" suffix, i.e. **LNP29BPK25**, are bulk packed 25 per carton.
* Items indicated are UL recognized components.
Δ Panzergewinde.



LNP29BPK25



Cord Connector Parts

N.P.T. Hub Size	Cord Diameter Inches (mm)	Form Size	Bushing Catalog Number	Color Code	GOTCHA® Ring Catalog Number
¼, ⅜, ½	.062"-.125" (1.58-3.17)	F1	31518101BPK100	Green	31648035GPK100
	.125"-.187" (3.17-4.76)		31518102BPK100	Orange	31648036GPK100
	.187"-.250" (4.76-6.35)		31518103BPK100	Red	31648037GPK100
	.250"-.312" (6.35-7.93)		31518104BPK100	Black	31648038GPK100
	.312"-.375" (7.93-9.50)		31518105BPK100	White	31605010GPK100
	.375"-.437" (9.50-11.1)		31518106BPK100	Blue	31648039GPK100
½, ¾	.187"-.250" (4.76-6.35)	F2	31518110BPK100	Red	31648042GPK100
	.250"-.375" (6.35-9.50)		31518111BPK100	White	31605015GPK100
	.375"-.500" (9.50-12.7)		31518112BPK100	Blue	31648043GPK100
	.500"-.625" (12.7-15.8)		31518113BPK100	Brown	31648044GPK100
½, ¾	.375"-.500" (9.50-12.7)	F3	31518116BPK100	Blue	31648045GPK100
	.500"-.625" (12.7-15.8)		31518117BPK100	Brown	31648046GPK100
	.625"-.750" (15.8-19.0)		31518118BPK100	Yellow	31648047GPK100
	.750"-.875" (19.0-22.2)		31518119BPK100	Orchid	31648048GPK100
1	.500"-.625" (12.7-15.8)	F4	31518123BPK100	Brown	31648050GPK100
	.625"-.750" (15.8-19.0)		31518124BPK100	Yellow	31648051GPK100
	.750"-.875" (19.0-22.2)		31518125BPK100	Orchid	31648052GPK100
	.875"-.1.00" (22.2-25.4)		31518126BPK100	Gray	31648053GPK100
	1.00"-.1.125" (25.4-28.5)		31518127BPK100	Pink	31648054GPK100

Note: Catalog numbers above with "PK100" suffix, i.e. 31518101BPK100, are bulk packed 100 per carton.

Locknuts — Steel and Non-Metallic

N.P.T. Hub Size	Zinc-Plated Steel	Non-Metallic
¼	—	31622001LPK50
⅜	—	31622002LPK50
½	00322001LPK50	31622003LPK50
¾	00322002LPK50	31622007LPK50
1	00322003LPK50	31622008LPK50
1¼	00322004LPK50	—
1½	00322005LPK50	—

Note: Catalog numbers above with "PK50" suffix, i.e. 00322001LPK50, are bulk packed 50 per carton. See page T-101 for additional technical data and dimensional drawings.



Zinc-Plated Steel Locknuts



Non-Metallic Locknuts



Metal Clad Sealing O-Rings

Metal Clad Sealing O-Rings

N.P.T. Hub Size	Catalog Number
½	20509001
¾	20509002
1	20509003
1¼	20509004
1½	20509005
2	20509006
2½	20509007
3	20509008

Note: See page T-101 for additional technical data and dimensional drawings.



Kellems® Wire Management Products
Hubbell Juniors® Miniature Connectors



Hubbell Juniors are a miniature liquidtight version of the full-sized Hubbell cord connectors. They feature the same GOTCHA® ring technology and neoprene bushings. They also come with or without a nylon spiral for arc-of-bend control and longer cord life. They are available in 1/4", 3/8", and 1/2" N.P.T. sizes in both gray and black.

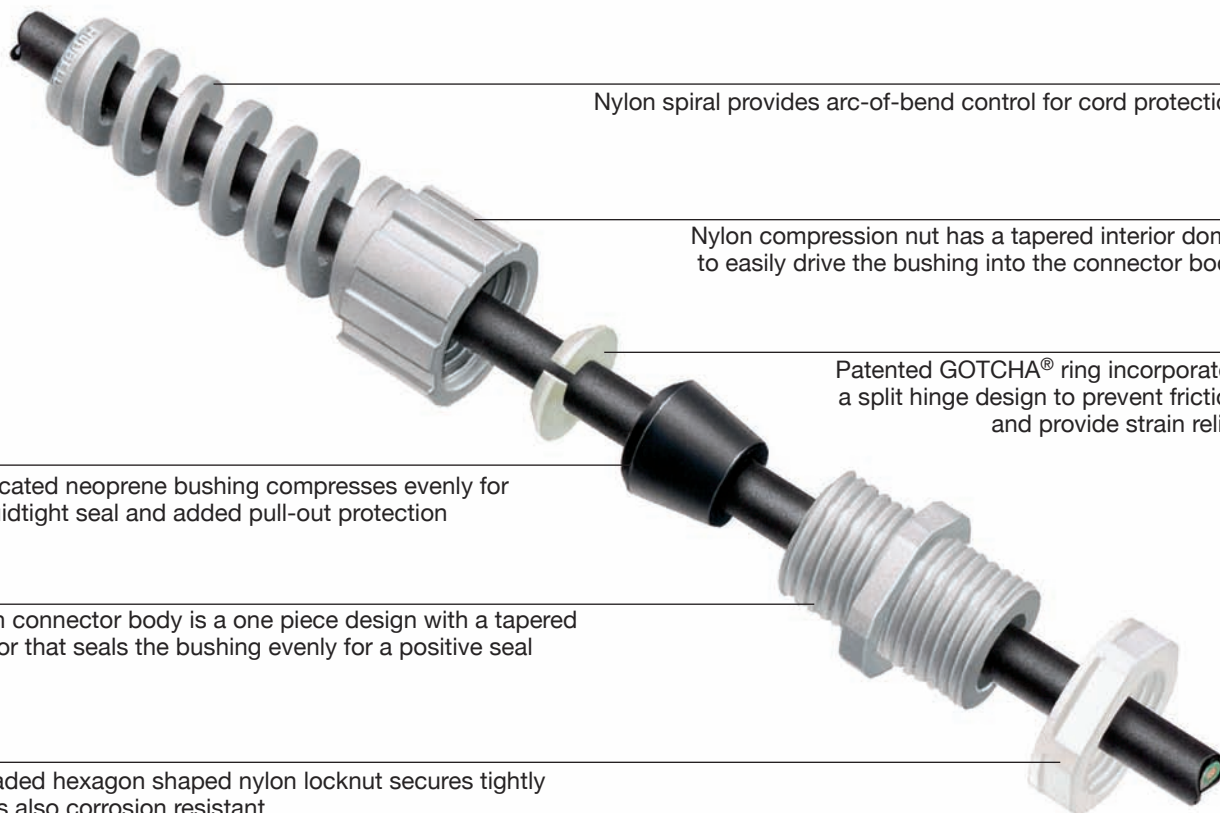

Nylon spiral provides arc-of-bend control for cord protection

Nylon compression nut has a tapered interior dome to easily drive the bushing into the connector body

Patented GOTCHA® ring incorporates a split hinge design to prevent friction and provide strain relief

Lubricated neoprene bushing compresses evenly for a liquidtight seal and added pull-out protection

Nylon connector body is a one piece design with a tapered interior that seals the bushing evenly for a positive seal

Threaded hexagon shaped nylon locknut secures tightly and is also corrosion resistant

Kellems® Wire Management Products

Hubbell Juniors® Miniature Nylon Cord Connectors



Miniature Nylon Cord Connector

N.P.T. Hub Size	Cord Diameter Range Inches (mm)	Gray	Black
1/4	.08"-.14" (1.9-3.4)	HJ1001GPK25	HJ1001BPK25
	.14"-.20" (3.4-5.1)	HJ1002GPK25	HJ1002BPK25
	.20"-.27" (5.1-6.7)	HJ1003GPK25	HJ1003BPK25
3/8	.15"-.21" (3.7-5.3)	HJ1004GPK25	HJ1004BPK25
	.21"-.28" (5.3-7.0)	HJ1005GPK25	HJ1005BPK25
	.28"-.34" (7.0-8.6)	HJ1006GPK25	HJ1006BPK25
1/2	.06"-.13" (1.6-3.2)	HJ1055GPK25	HJ1055BPK25
	.13"-.19" (3.2-4.7)	HJ1056GPK25	HJ1056BPK25
	.19"-.25" (4.7-6.3)	HJ1057GPK25	HJ1057BPK25
	.25"-.31" (6.3-7.9)	HJ1058GPK25	HJ1058BPK25
	.31"-.38" (7.9-9.5)	HJ1059GPK25	HJ1059BPK25
	.38"-.44" (9.5-11.1)	HJ1060GPK25	HJ1060BPK25



Gray Cord Connector



Black Cord Connector

Miniature Nylon Cord Connector with Spiral

N.P.T. Hub Size	Cord Diameter Range Inches (mm)	Gray	Black
1/4	.08"-.14" (1.9-3.4)	HJ1010GPK25	HJ1010BPK25
	.14"-.20" (3.4-5.1)	HJ1011GPK25	HJ1011BPK25
	.20"-.27" (5.1-6.7)	HJ1012GPK25	HJ1012BPK25
3/8	.15"-.21" (3.7-5.3)	HJ1013GPK25	HJ1013BPK25
	.21"-.28" (5.3-7.0)	HJ1014GPK25	HJ1014BPK25
	.28"-.34" (7.0-8.6)	HJ1015GPK25	HJ1015BPK25
1/2	.13"-.19" (3.2-4.7)	HJ1038GPK25	HJ1038BPK25
	.19"-.25" (4.7-6.3)	HJ1039GPK25	HJ1039BPK25
	.25"-.31" (6.3-7.9)	HJ1040GPK25	HJ1040BPK25
	.31"-.38" (7.9-9.5)	HJ1041GPK25	HJ1041BPK25
	.38"-.44" (9.5-11.1)	HJ1042GPK25	HJ1042BPK25
3/4	.25"-.49" (6.4-12.3)	HJ1043GPK25*	HJ1043BPK25*
	.45"-.71" (11.4-18.0)	HJ1044GPK25*	HJ1044BPK25*



Gray Cord Connector with Spiral



Black Cord Connector with Spiral

Note: * Locknuts sold separately. See page T-89.

Miniature Nylon Snap-In Cord Connector with Spiral

Cord Diameter Range Inches (mm)	For Chassis Thickness	Gray	Black
.22"-.27" (5.6-6.9)	.10" (2.5) Max	HS1001GPK25	HS1001BPK25
.28"-.32" (7.1-8.1)	.10" (2.5) Max	HS1002GPK25	HS1002BPK25
.30"-.36" (7.6-9.1)	.13" (3.2) Max	HS1003GPK25	HS1003BPK25
.32"-.43" (8.1-10.9)	.13" (3.2) Max	HS1004GPK25	HS1004BPK25

Note: Catalog numbers above with "PK25" suffix, i.e. HJ1001GPK25, are bulk packed 25 per carton. See pages T-102 and T-103 for additional technical data and dimensional drawings.



Gray Snap-In
Cord Connector



Black Snap-In
Cord Connector



Kellems® Wire Management Products

Technical Information

Cord Connectors

Operating Temperatures

Material	Temperature Range
Aluminum	-40°F to +300°F (-40°C to +149°C)
Nylon (connectors and GOTCHA® rings)	-40°F to +225°F (-40°C to +107°C)
Plated steel*	-60°F to +1000°F (-51°C to +537°C)
Stainless steel*	-60°F to +1000°F (-51°C to +537°C)
Neoprene (bushings)	-30°F to +240°F (-34°C to +115°C)

Note: * Due to the limiting factors of nylon and neoprene, any complete cord connector with a GOTCHA ring, Form 1-5, will continuously perform in the range of -30°F to +225°F (-34°C to +107°C).

Cord connectors without GOTCHA rings, Form 6-8, will continuously operate in the range -30°F to +240°F (-34°C to +115°C) due to the limiting factor of neoprene.

Hazardous Locations

Hubbell cord connectors are suitable for use in hazardous locations per Class I Div. 2, Class II Div. 1 & 2, Class III Div. 1 & 2 in accordance with the NEC.

Flammability

Hubbell nylon cord connectors have a UL 94-V2 rating.

Approvals**Agency**

UL Listed in accordance with Standard 514B.

CSA Certified.

United States Coast Guard Approved, Title 46-Part 111.

Form Size Definition

The term "Form Size" refers to the physical overall size of a cord connector.

Form 1 is the smallest size.

Form 8 is the largest size.

Knockout Holes

N.P.T. Hub Size	Knockout Hole Recommended Min. to Max.		Knockout Hole Recommended PG Hub Size	Knockout Hole Recommended Inches (mm)		Knockout Hole Recommended Metric Hub Size	Knockout Hole Recommended Inches (mm)	
	Inches	(mm)		Inches	(mm)		Inches	(mm)
¼	.54"-.57"	(13.7-14.5)	PG7	.492"	(12.5)	M12	.472"	(12)
⅜	.67"-.70"	(17.0-17.8)	PG9	.599"	(15.2)	M16	.629"	(16)
½	.86"-.91"	(21.8-23.0)	PG11	.733"	(18.6)	M20	.787"	(20)
¾	1.04"-1.09"	(26.4-27.8)	PG13.5	.804"	(20.4)	M25	.984"	(25)
1	1.36"-1.41"	(34.5-35.7)	PG16	.888"	(22.5)	M32	1.25"	(32)
1¼	1.72"-1.77"	(43.7-44.9)	PG21	1.15"	(28.3)	M40	1.57"	(40)
1½	1.97"-2.02"	(50.0-51.2)	PG29	1.47"	(34.3)			
2	2.45"-2.50"	(62.3-63.5)	PG36	1.85"	(47.0)			
2½	2.95"-3.00"	(75.0-76.2)						
3	3.58"-3.63"	(90.9-92.1)						

N.P.T., PG and Metric Thread Low Profile Connectors

SECP29G

Specifications

Material	6/6 Nylon.
Gland	Buna N.
Temperature Range	-22°F to 225°F (-30°C to 107°C). Cord Connectors are Halogen and Silicon free.
Protection Class	IP66 Suitability.
Flammability	UL 94V-2.
Listings/Certifications	UL Listing File E-41567, UL Recognition File E-41567. CSA File LR27378C, VDE Marks Licence #136681.



Straight Hubbell Connectors

F	Aluminum Inches (mm)						Nylon Inches (mm)						
	N.P.T.	Form	A Dia.	B Ref.	C	D Throat Dia.	E A/C*	E A/F*	A Dia.	B Ref.	C	D Throat Dia.	E A/C*
¼-18	1	.88" (22.4)	.90" (22.9)	.46" (11.7)	.32" (8.1)	.99" (25.1)	.88" (22.4)	1.00" (25.4)	1.10" (27.9)	.43" (10.9)	.33" (8.4)	1.00" (25.4)	.93" (23.6)
¾-18	1	.88" (22.4)	.90" (22.9)	.46" (11.7)	.44" (11.2)	.99" (25.1)	.88" (22.4)	1.00" (25.4)	1.10" (27.9)	.43" (10.9)	.45" (11.4)	1.00" (25.4)	.93" (23.6)
½-14	1	.88" (22.4)	.90" (22.9)	.46" (11.7)	.44" (11.2)	1.00" (25.4)	.88" (22.4)	1.00" (25.4)	1.10" (27.9)	.46" (11.7)	.45" (11.4)	1.00" (25.4)	.93" (23.6)
½-14	2	1.13" (28.7)	1.10" (27.9)	.55" (14.0)	.64" (16.3)	1.11" (28.2)	1.00" (25.4)	1.32" (33.5)	1.50" (38.1)	.53" (13.5)	.58" (14.7)	1.25" (31.7)	1.12" (28.4)
½-14	3	1.38" (35.1)	1.50" (38.1)	.55" (14.0)	.64" (16.3)	1.40" (35.6)	1.25" (31.7)	—	—	—	—	—	—
¾-14	2	1.13" (28.7)	1.10" (27.9)	.55" (14.0)	.64" (16.3)	1.29" (32.8)	1.13" (28.7)	—	—	—	—	—	—
¾-14	3	1.38" (35.1)	1.50" (38.1)	.55" (14.0)	.82" (20.8)	1.40" (35.6)	1.25" (31.7)	1.56" (39.6)	1.60" (40.6)	.55" (14.0)	.77" (19.6)	1.44" (36.6)	1.31" (33.3)
1-11½	4	1.75" (44.4)	1.60" (40.6)	.71" (18.0)	1.02" (25.9)	1.81" (46.0)	1.62" (41.1)	1.88" (47.8)	1.75" (44.4)	.70" (17.8)	1.01" (25.7)	1.84" (46.7)	1.63" (41.4)
1-11½	5	2.31" (58.7)	1.70" (43.2)	.66" (16.8)	1.01" (25.7)	2.28" (57.9)	2.00" (50.8)	—	—	—	—	—	—
1¼-11½	5	2.31" (58.7)	1.70" (43.2)	.74" (18.8)	1.26" (32.0)	2.28" (57.9)	2.12" (53.8)	—	—	—	—	—	—
1½-11½	5	2.31" (58.7)	1.70" (43.2)	.74" (18.8)	1.38" (35.1)	2.28" (57.9)	2.12" (53.8)	—	—	—	—	—	—
1½-11½	6	3.00" (76.2)	2.20" (55.9)	.75" (19.0)	1.50" (38.1)	2.97" (75.4)	2.75" (69.8)	—	—	—	—	—	—
2-11½	6	3.00" (76.2)	2.20" (55.9)	.80" (20.3)	1.92" (48.8)	3.24" (82.4)	3.00" (76.2)	—	—	—	—	—	—
2-11½	7	3.85" (97.8)	2.70" (68.6)	.88" (22.4)	1.94" (49.3)	4.05" (102.9)	3.75" (95.2)	—	—	—	—	—	—
2½-8	7	3.85" (97.8)	2.70" (68.6)	1.30" (33.0)	2.32" (58.9)	4.34" (110.2)	4.02" (102.1)	—	—	—	—	—	—
2½-8	8	4.75" (120.6)	2.70" (68.6)	1.25" (31.7)	2.38" (60.5)	4.86" (123.4)	4.50" (114.3)	—	—	—	—	—	—
3-8	7	3.85" (97.8)	2.70" (68.6)	1.30" (33.0)	2.54" (64.5)	4.34" (110.2)	4.02" (102.1)	—	—	—	—	—	—
3-8	8	4.50" (114.3)	2.70" (68.6)	1.38" (35.1)	3.00" (76.2)	4.86" (123.4)	4.50" (114.3)	—	—	—	—	—	—

Note: *A/C— Across Corners; A/F—Across Flats.

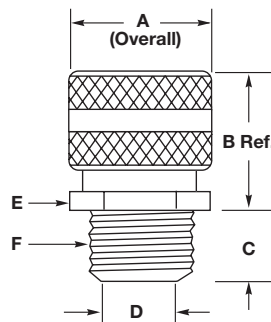

Dimensions shown are approximate and are subject to change without notice.



Kellems® Wire Management Products

Technical Information

Cord Connectors

Straight Hubbell Connectors

F	Form	Zinc-Plated Steel Inches (mm)							Stainless Steel Inches (mm)							
		A		B	C	D	E	Throat Dia.	A		B	C	D	E		
N.P.T.		A/C*	A/F*	Ref.					A/C*	A/F*			Throat Dia.	A/C*	A/F*	
¼-18	1	—	—	—	—	—	—	—	—	1.01"	.88"	.90"	.46"	.38"	.87"	.75"
		(24.9)	(22.4)	(22.9)	(10.7)	(11.4)	(25.1)	(22.4)	(25.7)	(22.4)	(22.9)	(11.7)	(9.7)	(22.1)	(19.0)	
⅜-18	1	.98"	.88"	.90"	.42"	.45"	.99"	.88"	1.01"	.88"	.90"	.46"	.45"	.87"	.75"	
		(24.9)	(22.4)	(22.9)	(10.7)	(11.4)	(25.1)	(22.4)	(25.7)	(22.4)	(22.9)	(11.7)	(11.4)	(22.1)	(19.0)	
½-14	1	.98"	.88"	.90"	.55"	.45"	1.00"	.88"	—	—	—	—	—	—	—	
		(24.9)	(22.4)	(22.9)	(14.0)	(11.4)	(25.4)	(22.4)								
½-14	2	1.27"	1.13"	1.20"	.55"	.64"	1.10"	1.00"	1.30"	1.13"	1.10"	.54"	.63"	1.16"	1.00"	
		(32.3)	(28.7)	(30.5)	(14.0)	(16.3)	(28.2)	(25.4)	(33.0)	(28.7)	(27.9)	(13.7)	(16.0)	(29.5)	(25.4)	
½-14	3	1.55"	1.38"	1.50"	.55"	.64"	1.40"	1.25"	—	—	—	—	—	—	—	
		(39.4)	(35.1)	(38.1)	(14.0)	(16.3)	(35.6)	(31.7)								
¾-14	2	1.27"	1.13"	1.20"	.55"	.64"	1.29"	1.13"	—	—	—	—	—	—	—	
		(32.3)	(28.7)	(30.5)	(14.0)	(16.3)	(32.8)	(28.7)								
¾-14	3	1.55"	1.38"	1.40"	.55"	.82"	1.40"	1.25"	1.59"	1.38"	1.30"	.56"	.81"	1.44"	1.25"	
		(39.4)	(35.1)	(35.6)	(14.0)	(20.8)	(35.6)	(31.7)	(40.4)	(35.1)	(33.0)	(14.2)	(20.6)	(36.6)	(31.7)	
1-11½	3	1.55"	1.38"	1.40"	.70"	.89"	1.54"	1.38"	—	—	—	—	—	—	—	
		(39.4)	(35.1)	(35.6)	(17.8)	(22.6)	(39.1)	(35.1)								
1-11½	4	1.92"	1.69"	1.60"	.70"	1.02"	1.95"	1.69"	2.02"	1.75"	1.40"	.70"	1.03"	1.88"	1.63"	
		(48.8)	(42.9)	(40.6)	(17.8)	(25.9)	(49.5)	(42.9)	(51.3)	(44.4)	(35.6)	(17.8)	(26.2)	(47.8)	(41.4)	
1-11½	5	2.40"	—	1.70"	.70"	1.02"	2.46"	2.15"	—	—	—	—	—	—	—	
		(61.0)		(43.2)	(17.8)	(25.9)	(62.5)	(54.6)								
1¼-11½	5	2.40"	—	1.70"	.73"	1.27"	2.48"	2.19"	—	—	—	—	—	—	—	
		(61.0)		(43.2)	(18.5)	(32.3)	(63.0)	(55.6)								
1½-11½	5	2.40"	—	1.70"	.74"	1.39"	2.48"	2.19"	—	—	—	—	—	—	—	
		(61.0)		(43.2)	(18.8)	(35.3)	(63.0)	(55.6)								
1½-11½	6	3.06"	—	2.20"	.75"	1.52"	3.04"	2.83"	—	—	—	—	—	—	—	
		(77.7)		(55.9)	(19.0)	(38.6)	(77.2)	(71.9)								
2-11½	6	3.06"	—	2.20"	.78"	1.92"	3.32"	3.07"	—	—	—	—	—	—	—	
		(77.7)		(55.9)	(19.8)	(48.8)	(84.3)	(78.0)								
2-11½	7	3.95"	—	2.70"	.78"	1.99"	4.18"	3.89"	—	—	—	—	—	—	—	
		(100.3)		(68.6)	(19.8)	(50.5)	(106.2)	(98.8)								
2½-8	7	—	—	—	—	—	—	—	—	—	—	—	—	—	—	
2½-8	—	—	—	—	—	—	—	—	—	—	—	—	—	—	—	
3-8	7	—	—	—	—	—	—	—	—	—	—	—	—	—	—	
3-8	8	—	—	—	—	—	—	—	—	—	—	—	—	—	—	

Note: *A/C— Across Corners; A/F—Across Flats.

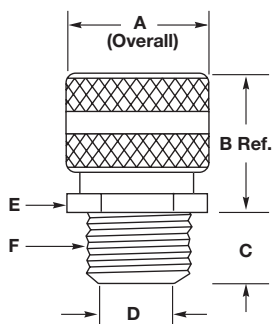

Dimensions shown are approximate and are subject to change without notice.



45° Hubbell Connectors

F	Aluminum Inches (mm)							Zinc Plated Steel Inches (mm)								
	A	B	C	D	E	G	A	B	C	D	E	G				
N.P.T.	Form	Ref.	Ref.	Throat Dia.	Across Corners	Across Flats	Dia.	Ref.	Ref.	Ref.	Throat Dia.	Across Corners	Across Flats	Across Corners	Across Flats	
1/2-14	2	2.00" (50.8)	1.90" (48.3)	.55" (14.0)	.56" (14.2)	1.27" (32.3)	1.10" (27.9)	1.13" (28.6)	1.97" (50.0)	1.90" (48.3)	.55" (14.0)	.57" (14.4)	1.24" (31.5)	1.06" (26.9)	1.27" (32.3)	1.13" (28.6)
3/4-14	3	2.30" (58.4)	2.50" (65.3)	.56" (14.2)	.75" (19.0)	1.48" (37.6)	1.28" (32.5)	1.38" (34.9)	—	—	—	—	—	—	—	—
1-11 1/2	4	2.60" (66.0)	2.80" (71.1)	.70" (17.8)	1.00" (25.4)	1.69" (42.9)	1.50" (38.1)	1.75" (44.4)	—	—	—	—	—	—	—	—
1 1/2-11 1/2	5	3.90" (99.1)	3.90" (99.1)	.74" (18.8)	1.25" (31.7)	2.45" (62.2)	2.13" (54.0)	2.31" (58.7)	—	—	—	—	—	—	—	—
1 1/2-11 1/2	5	3.90" (99.1)	3.90" (99.1)	.74" (18.8)	1.50" (38.1)	2.45" (62.2)	2.13" (54.0)	2.31" (58.7)	—	—	—	—	—	—	—	—

90° Hubbell Connectors

F	Aluminum Inches (mm)							Zinc Plated Steel Inches (mm)								
	A	B	C	D	E	G	A	B	C	D	E	G				
N.P.T.	Form	Ref.	Ref.	Throat Dia.	Across Corners	Across Flats	Dia.	Ref.	Ref.	Ref.	Throat Dia.	Across Corners	Across Flats	Across Corners	Across Flats	
3/8-18	1	1.27" (32.3)	2.00" (50.8)	.46" (11.7)	.44" (11.2)	1.15" (29.2)	1.10" (27.9)	.88" (22.2)	—	—	—	—	—	—	—	—
1/2-14	2	1.56" (39.6)	2.30" (58.4)	.50" (12.7)	.55" (13.9)	1.30" (33.0)	1.13" (28.7)	1.13" (28.6)	1.65" (41.9)	2.38" (60.5)	.55" (14.0)	.55" (13.8)	1.29" (32.8)	1.13" (28.7)	1.27" (32.3)	1.13" (28.6)
3/4-14	3	1.79" (45.5)	2.80" (71.1)	.56" (14.2)	.77" (19.4)	1.49" (37.8)	1.31" (33.3)	1.38" (34.9)	1.88" (47.8)	2.90" (73.7)	.56" (14.2)	.77" (19.4)	1.52" (38.6)	1.33" (33.8)	1.55" (39.2)	1.38" (34.9)
1-11 1/2	4	2.08" (52.8)	3.20" (81.3)	.70" (17.8)	1.00" (25.4)	1.70" (43.2)	1.50" (38.1)	1.75" (44.4)	2.16" (54.9)	3.20" (81.3)	.70" (17.8)	1.00" (25.4)	1.72" (43.7)	1.50" (38.1)	1.92" (48.8)	1.69" (42.8)
1 1/4-11 1/2	5	3.18" (80.8)	4.30" (109.2)	.73" (18.5)	1.26" (32.0)	2.47" (62.7)	2.15" (54.6)	2.31" (58.7)	—	—	—	—	—	—	—	—
1 1/2-11 1/2	5	3.18" (80.8)	4.30" (109.2)	.75" (19.2)	1.50" (38.1)	2.47" (62.7)	2.15" (54.6)	2.31" (58.7)	—	—	—	—	—	—	—	—
2-11 1/2	6	3.51" (89.2)	5.50" (139.7)	.80" (20.3)	1.92" (48.8)	2.98" (75.7)	2.78" (70.6)	3.00" (76.2)	—	—	—	—	—	—	—	—

90° Hubbell Connectors

F	Nylon Inches (mm)							
	A	B	C	D	E	G		
N.P.T.	Form	Ref.	Ref.	Throat Dia.	Across Corners	Across Flats	Dia.	
3/8-18	1	—	—	—	—	—	—	
1/2-14	2	1.41" (35.8)	2.50" (63.5)	.55" (14.0)	.58" (14.6)	1.23" (31.2)	1.12" (28.2)	1.32" (33.4)
3/4-14	3	1.65" (41.9)	2.81" (71.4)	.56" (14.2)	.77" (19.4)	1.42" (36.1)	1.29" (32.8)	1.56" (39.6)
1-11 1/2	4	1.99" (50.5)	3.30" (83.8)	.70" (17.8)	1.01" (25.7)	1.82" (46.2)	1.60" (40.6)	1.88" (47.6)

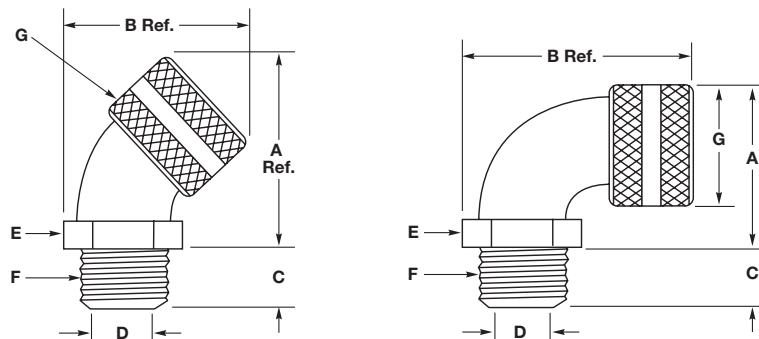

Dimensions shown are approximate and are subject to change without notice.





Kellems® Wire Management Products

Technical Information

Cord Connectors

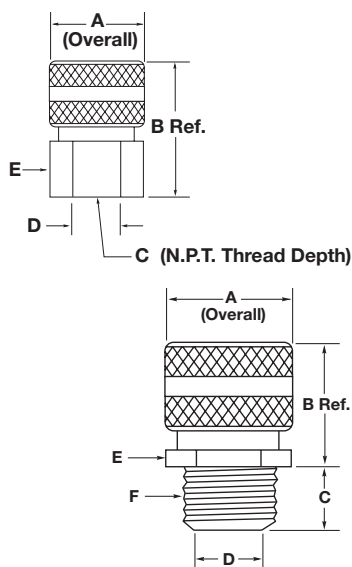

Female Hubbell Connectors

Aluminum		Inches (mm)						
F		A	B	C	D	E		
N.P.T.	Form	Dia.	Ref.		Throat Dia.	Across Corners	Across Flats	
3/8-18	1	.88" (22.4)	1.40" (35.6)	.56" (14.2)	.44" (11.2)	.94" (23.9)	.81" (20.6)	
1/2-14	2	1.13" (28.7)	1.80" (45.7)	.56" (14.2)	.63" (16.0)	1.15" (29.2)	1.00" (25.4)	
3/4-14	2	1.13" (28.7)	2.10" (53.3)	.75" (19.0)	.63" (16.0)	1.44" (36.6)	1.25" (31.7)	
1-11 1/2	4	1.75" (44.5)	2.30" (58.4)	.88" (22.4)	1.10" (27.9)	1.88" (47.8)	1.63" (41.4)	
1 1/4-11 1/2	5	2.31" (58.7)	2.80" (71.1)	.95" (24.1)	1.43" (36.3)	2.64" (67.1)	2.29" (58.2)	
1 1/2-11 1/2	5	2.31" (58.7)	2.80" (71.1)	.95" (24.1)	1.43" (36.3)	2.64" (67.1)	2.29" (58.2)	

Underground Feeder Connectors

F	Aluminum Inches (mm)					Nylon Inches (mm)					Zinc-Plated Steel Inches (mm)									
	A	B	C	D	E	A	B	C	D	E	A	B	C	D	E					
N.P.T.	Form	Dia.	Ref.	Thrt. Dia.	A/C*	A/F*	Dia.	Ref.	Thrt. Dia.	A/C*	A/F*	A/C*	A/F*	Ref.	Thrt. Dia.	A/C*	A/F*			
1/2-14	2	1.13" (28.7)	1.10" (27.9)	.55" (14.0)	.64" (16.3)	1.10" (27.9)	1.00" (25.4)	1.32" (33.5)	1.50" (38.1)	.55" (14.0)	.58" (14.7)	1.25" (31.7)	1.13" (28.7)	1.27" (32.3)	1.13" (28.7)	1.20" (30.5)	.55" (14.0)	.64" (16.3)	1.11" (28.2)	1.00" (25.4)
3/4-14	2	1.13" (28.7)	1.10" (27.9)	.55" (14.0)	.64" (16.3)	1.29" (32.8)	1.13" (25.4)	—	—	—	—	—	—	1.27" (32.3)	1.13" (28.7)	1.20" (30.5)	.55" (14.0)	.64" (16.3)	1.29" (32.8)	1.13" (28.7)
3/4-14	3	1.13" (28.7)	1.50" (38.1)	.55" (14.0)	.82" (20.8)	1.40" (35.6)	1.25" (31.7)	1.56" (39.6)	1.60" (40.6)	.56" (14.2)	.77" (19.6)	1.44" (36.6)	1.31" (33.3)	1.55" (39.4)	1.38" (35.1)	1.40" (35.6)	.56" (14.2)	.82" (20.8)	1.40" (35.6)	1.25" (31.7)

Note: *A/C - Across Corners; A/F - Across Flats.

Low Profile Non-Metallic N.P.T., PG and Metric Thread Connectors

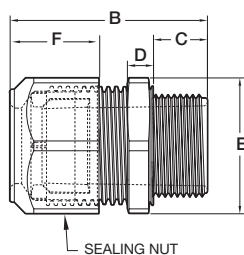

Hub Size	Nylon Inches (mm)					
	A	B	C	D	E	F
3/8 N.P.T.	0.670" (17.0)	1.41" (35.8)	0.48" (12.4)	0.21" (5.3)	0.83" (21.0)	0.55" (14.0)
1/2 N.P.T.	0.875" (22.2)	1.70" (43.2)	0.61" (15.5)	0.21" (5.3)	0.88" (24.8)	0.66" (16.8)
3/4 N.P.T.	1.068" (27.1)	2.00" (50.8)	0.62" (15.7)	0.25" (6.3)	1.30" (33.0)	0.85" (21.6)
1 N.P.T.	1.375" (35.0)	2.41" (61.2)	0.76" (19.3)	0.30" (7.6)	1.73" (43.9)	1.05" (26.7)
PG7	0.492" (12.5)	1.16" (29.5)	0.32" (8.1)	0.21" (5.3)	0.63" (16.0)	0.48" (12.4)
PG9	0.599" (15.2)	1.25" (31.8)	0.32" (8.1)	0.21" (5.3)	0.83" (21.0)	0.55" (14.0)
PG11	0.733" (18.6)	1.48" (37.6)	0.38" (9.7)	0.21" (5.3)	0.94" (23.9)	0.70" (17.8)
PG13.5	0.804" (20.4)	1.53" (38.9)	0.41" (10.4)	0.21" (5.3)	0.98" (24.9)	0.66" (16.8)
PG16	0.888" (22.5)	1.68" (42.7)	0.44" (11.2)	0.25" (6.4)	1.06" (27.0)	0.76" (19.3)
PG21	1.15" (28.3)	1.89" (48.0)	0.52" (13.2)	0.25" (6.4)	1.30" (33.0)	.085" (21.6)
PG29	1.47" (37.30)	2.23" (56.6)	0.58" (14.7)	0.30" (7.6)	1.73" (43.9)	1.05" (26.7)
PG36	1.85" (47.0)	2.39" (60.7)	0.47" (11.9)	0.31" (7.9)	2.05" (52.7)	1.19" (30.2)
M12	0.473" (12.0)	1.16" (29.5)	0.32" (8.1)	0.21" (5.3)	0.63" (16.0)	0.49" (12.4)
M16	0.630" (16.0)	1.25" (31.8)	0.32" (8.1)	0.21" (5.3)	0.83" (21.0)	0.55" (14.0)
M20	0.787" (20.0)	1.53" (38.9)	0.41" (10.4)	0.21" (5.3)	0.98" (24.9)	0.66" (16.8)
M25	0.985" (25.0)	1.89" (48.0)	0.52" (13.2)	0.25" (6.3)	1.30" (33.0)	0.85" (21.6)
M32	1.260" (32.0)	2.23" (56.6)	0.58" (14.7)	0.30" (7.6)	1.73" (43.9)	1.05" (26.7)
M40	1.575" (40.0)	2.39" (60.7)	0.48" (12.2)	0.30" (7.6)	2.05" (52.1)	1.19" (30.2)



2 Conductors

Cord Type		SVO, SV, SVT	SJ, SJO, SJT, SJTO				S, SO, ST, STO				
Cord Size		#18	#18	#16	#14	#18	#16	#14	#12	#10	#8
Approximate Diameter		.25" (6.2)	.31" (7.8)	.33" (8.4)	.37" (9.3)	.38" (9.7)	.40" (10.2)	.54" (13.7)	.62" (15.6)	.68" (17.1)	.81" (20.6)
Color		Black	Black	White	White	Blue	Blue	Brown	Brown	Yellow	Orchid
N.P.T.	Form	Catalog Number*									
¼	1	HC1004	HC1004	HC1005	HC1005	HC1006	HC1006	—	—	—	—
⅜	1	HC1010	HC1010	HC1011	HC1011	HC1012	HC1012	—	—	—	—
½	1	HC1016	HC1016	HC1017	HC1017	HC1018	HC1018	—	—	—	—
½	2	HC1022	HC1022	HC1022	HC1022	HC1023	HC1023	HC1024	HC1024	—	—
½	3	—	—	—	—	HC1025	HC1025	HC1026	HC1026	HC1027	HC1028
¾	2	HC1032	HC1032	HC1032	HC1032	HC1033	HC1033	HC1034	HC1034	—	—
¾	3	—	—	—	—	HC1035	HC1035	HC1036	HC1036	HC1037	HC1038
1	4	—	—	—	—	HC1039	HC1039	HC1040	HC1040	HC1041	HC1042
1	5	—	—	—	—	—	—	—	—	—	HC1045
1¼	5	—	—	—	—	—	—	—	—	—	HC1050
1½	5	—	—	—	—	—	—	—	—	—	HC1055
1½	6	—	—	—	—	—	—	—	—	—	—
2	6	—	—	—	—	—	—	—	—	—	—
2	7	—	—	—	—	—	—	—	—	—	—
2½	7	—	—	—	—	—	—	—	—	—	—
3	7	—	—	—	—	—	—	—	—	—	—

Note: * Must add prefix, see Note 1; suffix, see Note 2, on page T-100.

‡ F5 and larger will not be color coded.

3 Conductors

Cord Type		SVO, SV, SVT	SJ, SJO, SJT, SJTO				S, SO, ST, STO				
Cord Size		#18	#18	#16	#14	#18	#16	#14	#12	#10	#8
Approximate Diameter		.26" (6.5)	.33" (8.3)	.35" (8.9)	.39" (9.8)	.39" (9.9)	.42" (10.7)	.57" (14.4)	.65" (16.4)	.71" (18.0)	.85" (21.5)
Color		Black	White	White	Blue	Blue	Blue	Brown	Yellow	Yellow	Orchid
N.P.T.	Form	Catalog Number*									
¼	1	HC1004	HC1005	HC1005	HC1006	HC1006	HC1006	—	—	—	—
⅜	1	HC1010	HC1011	HC1011	HC1012	HC1012	HC1012	—	—	—	—
½	1	HC1016	HC1017	HC1017	HC1018	HC1018	HC1018	—	—	—	—
½	2	HC1022	HC1022	HC1022	HC1023	HC1023	HC1023	HC1024	—	—	—
½	3	—	—	—	HC1025	HC1025	HC1025	HC1026	HC1027	HC1027	HC1028
¾	2	HC1032	HC1032	HC1032	HC1033	HC1033	HC1033	HC1034	—	—	—
¾	3	—	—	—	HC1035	HC1035	HC1035	HC1036	HC1037	HC1037	HC1038
1	4	—	—	—	HC1039	HC1039	HC1039	HC1040	HC1041	HC1041	HC1042
1	5	—	—	—	—	—	—	—	—	—	HC1045
1¼	5	—	—	—	—	—	—	—	—	—	HC1050
1½	5	—	—	—	—	—	—	—	—	—	HC1055
1½	6	—	—	—	—	—	—	—	—	—	—
2	6	—	—	—	—	—	—	—	—	—	—
2	7	—	—	—	—	—	—	—	—	—	—
2½	7	—	—	—	—	—	—	—	—	—	—
3	7	—	—	—	—	—	—	—	—	—	—

Note: * Must add prefix, see Note 1; suffix, see Note 2, on page T-100.

‡ F5 and larger will not be color coded.





Kellems® Wire Management Products

Technical Information

Cord Connectors

2 Conductors

Cord Type		SVO, SV, SVT	SJ, SJO, SJT, SJTO				S, SO, ST, STO				
Cord Size		#6	#4	#3	#2	#1	#1/0	#2/0	#3/0	#4/0	#250
Approximate Diameter		.94" (23.8)	1.08" (27.4)	1.17" (29.7)	1.27" (33.3)	1.44" (36.6)	1.52" (38.6)	1.65" (41.9)	1.77" (45.0)	1.92" (48.8)	2.16" (51.9)
Color		Gray‡	Pink‡	‡	‡	‡	‡	‡	‡	‡	‡
N.P.T.	Form	Catalog Number*									
¼	1	—	—	—	—	—	—	—	—	—	—
⅜	1	—	—	—	—	—	—	—	—	—	—
½	1	—	—	—	—	—	—	—	—	—	—
½	2	—	—	—	—	—	—	—	—	—	—
½	3	—	—	—	—	—	—	—	—	—	—
¾	2	—	—	—	—	—	—	—	—	—	—
¾	3	—	—	—	—	—	—	—	—	—	—
1	4	HC1043	HC1044	—	—	—	—	—	—	—	—
1	5	HC1046	HC1047	HC1048	HC1049	—	—	—	—	—	—
1¼	5	HC1051	HC1052	HC1053	HC1054	—	—	—	—	—	—
1½	5	HC1056	HC1057	HC1058	HC1059	—	—	—	—	—	—
1½	6	—	—	—	HC1060	HC1061	HC1062	HC1063	HC1064	—	—
2	6	—	—	—	HC1065	HC1066	HC1067	HC1068	HC1069	—	—
2	7	—	—	—	—	—	—	—	HC1070	HC1071	HC1073
2½	7	—	—	—	—	—	—	—	HC1076	HC1077	HC1079
3	7	—	—	—	—	—	—	—	HC1086	HC1087	HC1089

Note: * Must add prefix, see Note 1; suffix, see Note 2, on page T-100.

‡ F5 and larger will not be color coded.

3 Conductors

CordType		SVO, SV, SVT	SJ, SJO, SJT, SJTO				S, SO, ST, STO				
Cord Size		#6	#4	#3	#2	#1	#1/0	#2/0	#3/0	#4/0	#250
Approximate Diameter		1.00" (25.4)	1.17" (29.7)	1.24" (31.5)	1.34" (34.0)	1.51" (38.4)	1.65" (41.9)	1.75" (44.5)	1.80" (48.0)	2.07" (52.6)	2.39" (60.7)
Color		Gray‡	‡	‡	‡	‡	‡	‡	‡	‡	‡
N.P.T.	Form	Catalog Number*									
¼	1	—	—	—	—	—	—	—	—	—	—
⅜	1	—	—	—	—	—	—	—	—	—	—
½	1	—	—	—	—	—	—	—	—	—	—
½	2	—	—	—	—	—	—	—	—	—	—
½	3	—	—	—	—	—	—	—	—	—	—
¾	2	—	—	—	—	—	—	—	—	—	—
¾	3	—	—	—	—	—	—	—	—	—	—
1	4	HC1044	—	—	—	—	—	—	—	—	—
1	5	HC1047	HC1048	HC1048	HC1049	—	—	—	—	—	—
1¼	5	HC1052	HC1053	HC1053	HC1054	—	—	—	—	—	—
1½	5	HC1057	HC1058	HC1058	HC1059	—	—	—	—	—	—
1½	6	—	—	—	HC1060	HC1062	HC1063	HC1064	—	—	—
2	6	—	—	—	HC1065	HC1067	HC1068	HC1069	—	—	—
2	7	—	—	—	—	—	—	—	HC1070	HC1071	HC1073
2½	7	—	—	—	—	—	—	—	HC1076	HC1077	HC1079
3	7	—	—	—	—	—	—	—	HC1086	HC1087	HC1089

Note: * Must add prefix, see Note 1; suffix, see Note 2, on page T-100.

‡ F5 and larger will not be color coded.





4 Conductors

Cord Type		SJ, SJO, SJT, SJTO			S, SO, ST, STO					
Cord Size		#18	#16	#14	#18	#16	#14	#12	#10	#8
Approximate Diameter		.36" (9.0)	.39" (9.8)	.43" (10.8)	.42" (10.7)	.45" (11.4)	.61" (15.5)	.70" (17.8)	.77" (19.4)	.97" (24.6)
Color		White	Blue	Blue	Blue	Blue	Brown	Yellow	Orchid	Gray‡
N.P.T.	Form	Catalog Number*								
¼	1	HC1005	HC1006	HC1006	HC1006	—	—	—	—	—
⅜	1	HC1011	HC1012	HC1012	HC1012	—	—	—	—	—
½	1	HC1017	HC1018	HC1018	HC1018	—	—	—	—	—
½	2	HC1022	HC1023	HC1023	HC1023	HC1023	HC1024	—	—	—
½	3	—	HC1025	HC1025	HC1025	HC1025	HC1026	HC1027	HC1028	—
¾	2	—	HC1033	HC1033	HC1033	HC1033	HC1034	—	—	—
¾	3	—	HC1035	HC1035	HC1035	HC1035	HC1036	HC1037	HC1038	—
1	4	—	HC1039	HC1039	HC1039	HC1039	HC1040	HC1041	HC1042	HC1043
1	5	—	—	—	—	—	—	—	—	HC1046
1¼	5	—	—	—	—	—	—	—	—	HC1051
1½	5	—	—	—	—	—	—	—	—	HC1056
1½	6	—	—	—	—	—	—	—	—	—
2	6	—	—	—	—	—	—	—	—	—
2	7	—	—	—	—	—	—	—	—	—
2½	7	—	—	—	—	—	—	—	—	—
3	7	—	—	—	—	—	—	—	—	—

Note: * Must add prefix, see Note 1; suffix, see Note 2, on page T-100.
‡ F5 and larger will not be color coded.

5 Conductors

Cord Type		S, SO, ST, STO						
Cord Size		#18	#16	#14	#12	#10	#8	#6
Approximate Diameter		.50" (12.7)	.54" (13.7)	.70" (17.7)	.76" (19.3)	.83" (21.1)	1.06" (26.9)	1.18" (30.0)
Color		Blue	Brown	Yellow	Orchid‡	Orchid‡	Pink‡	‡
N.P.T.	Form	Catalog Number*						
½	2	HC1023	HC1024	—	—	—	—	—
½	3	HC1025	HC1026	HC1027	HC1028	HC1028	—	—
¾	2	HC1033	HC1034	—	—	—	—	—
¾	3	HC1035	HC1036	HC1037	HC1038	HC1038	—	—
1	4	HC1039	HC1040	HC1041	HC1042	HC1042	HC1044	—
1	5	—	—	—	HC1045	HC1045	HC1047	HC1048
1¼	5	—	—	—	HC1050	HC1050	HC1052	HC1053
1½	5	—	—	—	HC1055	HC1055	HC1057	HC1058

Note: * Must add prefix, see Note 1; suffix, see Note 2, on page T-100.
‡ F5 and larger will not be color coded.





Kellems® Wire Management Products

Technical Information

Cord Connectors

4 Conductors

Cord Type		SJ, SJO, SJT, SJTO		S, SO, ST, STO						
Cord Size		#6	#4	#3	#2	#1	#1/0	#2/0	#3/0	#4/0
Approximate Diameter		.94" (23.8)	1.08" (27.4)	1.17" (29.7)	1.27" (33.3)	1.44" (36.6)	1.52" (38.6)	1.65" (41.9)	1.77" (45.0)	1.92" (48.8)
Color		Pink‡	‡	‡	‡	‡	‡	‡	‡	‡
N.P.T.	Form	Catalog Number*								
¼	1	—	—	—	—	—	—	—	—	—
⅜	1	—	—	—	—	—	—	—	—	—
½	1	—	—	—	—	—	—	—	—	—
½	2	—	—	—	—	—	—	—	—	—
½	3	—	—	—	—	—	—	—	—	—
¾	2	—	—	—	—	—	—	—	—	—
¾	3	—	—	—	—	—	—	—	—	—
1	4	HC1044	—	—	—	—	—	—	—	—
1	5	HC1047	HC1049	HC1049	—	—	—	—	—	—
1¼	5	HC1052	HC1054	HC1054	—	—	—	—	—	—
1½	5	HC1057	HC1059	HC1059	—	—	—	—	—	—
1½	6	—	HC1060	HC1060	HC1061	HC1063	HC1064	—	—	—
2	6	—	HC1064	HC1065	HC1066	HC1068	HC1069	—	—	—
2	7	—	—	—	—	—	HC1070	HC1071	HC1073	HC1074
2½	7	—	—	—	—	—	HC1076	HC1077	HC1079	HC1080
3	7	—	—	—	—	—	HC1086	HC1087	HC1089	HC1090

Note: * Must add prefix, see Note 1; suffix, see Note 2, below.

‡ F5 and larger will not be color coded.

Note:

1. Add the proper prefix to the HC number to identify the type of connector desired:
SHC = Straight Hubbell Connector
NHC = 90° Hubbell Connector
FHC = Female Hubbell Connector
VHC = 45° Hubbell Connector
2. Add the proper suffix to identify material desired:
Aluminum = No suffix
Zinc-Plated Steel = ZP
Corrosion Resistant Nylon = CR
Stainless Steel = SS

3. This chart is a general guide to assist in the selection of Hubbell Cord Connectors for various cord sizes. The Hubbell Cord Connector catalog numbers selected, have been inserted into spaces which in our judgment represent the best cord connector which will fit the listed cord size.
The diameters of the cords are approximate and may vary depending on the manufacturer. It is suggested that the appropriate cord manufacturer's dimension chart be consulted for exact dimensions.
4. Cable jacket may have to be stripped to allow conductors to pass through connector body.



N.P.T. Thread Locknuts

Zinc-Plated Steel

N.P.T. Hub Size	A Inside Dia. inches (mm)	B Outside Dia. inches (mm)	C Thk. inches (mm)	Steel Catalog Number
½	½"-14	1.14" (29.0)	.09" (2.3)	00322001LPK50
¾	¾"-14	1.43" (36.3)	.11" (2.8)	00322002LPK50
1	1"-11½	1.77" (45.0)	.13" (3.3)	00322003LPK50
1¼	1¼"-11½	2.28" (57.9)	.13" (3.3)	00322004LPK50
1½	1½"-11½	2.60" (66.0)	.13" (3.3)	00322005LPK50

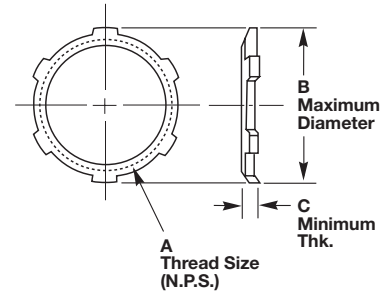

Metal Clad Sealing O-Rings – Sizes ½ - 4

Zinc-Plated Steel with Neoprene Ring

N.P.T. Hub Size	A Inside Dia. inches (mm)	B Outside Dia. inches (mm)	C Thk. inches (mm)	Catalog Number
½	.80" (20.3)	1.08" (27.4)	.16" (3.2)	20509001
¾	1.00" (25.4)	1.34" (34.0)	.16" (3.2)	20509002
1	1.25" (31.6)	1.63" (41.4)	.16" (3.2)	20509003
1¼	1.61" (40.9)	2.00" (50.8)	.16" (3.2)	20509004
1½	1.84" (46.7)	2.36" (59.9)	.16" (3.2)	20509005
2	2.31" (58.7)	2.83" (71.9)	.16" (3.2)	20509006

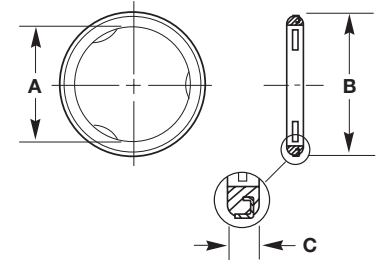

Chrome Plated Steel with Neoprene Ring

2½	2.91" (73.9)	3.44" (87.4)	.24" (6.1)	20509007
3	3.52" (89.4)	4.08" (103.6)	.24" (6.1)	20509008

Nylon PG Thread Locknuts

PG Thread Size	A inches (mm)	B inches (mm)	C inches (mm)	Catalog Number
PG7	.75" (19.1)	.80" (20.3)	.22" (5.6)	LNP7BPK100
PG9	.86" (21.8)	.91" (23.2)	.22" (5.6)	LNP9BPK100
PG11	.94" (23.9)	1.03" (26.2)	.22" (5.6)	LNP11BPK100
PG13.5	1.06" (26.9)	1.14" (29.0)	.24" (6.1)	LNP13BPK100
PG16	1.18" (30.0)	1.30" (33.0)	.25" (6.1)	LNP16BPK100
PG21	1.41" (35.8)	1.54" (39.1)	.25" (6.1)	LNP21BPK100
PG29	1.81" (46.0)	2.00" (50.8)	.25" (6.1)	LNP29BPK25
PG36	2.24" (56.9)	2.50" (63.5)	.25" (6.1)	LNP36BPK25

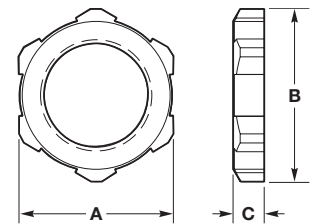

Nylon Metric Thread Locknuts

PG Thread Size	A inches (mm)	B inches (mm)	C inches (mm)	Catalog Number
M12	.75" (19.1)	.82" (20.8)	.22" (5.6)	LNM12BPK100
M16	.87" (22.09)	.98" (25.0)	.22" (5.6)	LNM16BPK100
M20	1.06" (27.0)	1.18" (30.0)	.25" (6.4)	LNM20BPK100
M25	1.38" (35.1)	1.54" (39.1)	.28" (7.1)	LNM25BPK100
M32	1.61" (40.9)	1.80" (45.7)	.28" (7.1)	LNM32BPK100
M40	1.97" (50.0)	2.18" (55.4)	.28" (7.1)	LNM40BPK100

Dimensions shown are approximate and are subject to change without notice.





Kellems® Wire Management Products

Technical Information

Hubbell Juniors® Miniature Nylon Cord Connectors

Hubbell Juniors®

Material	Operating Temperature Range
Nylon (connectors and GOTCHA® rings)	-40°F to +225°F (-40°C to +107°C)
Neoprene (bushings)	-30°F to +240°F (-34°C to +115°C)

Due to the limiting factors of nylon and neoprene, any complete liquidtight Hubbell Junior will continuously perform in the range of -30°F to +225°F (-34°C to +107°C).

Snap-In continuously performs -40°F to +225°F (-40°C to +107°C).

Flammability

Hubbell Juniors have a UL 94V-2 rating.

Certifications

Product	Agency
Liquidtight and Liquidtight with Spiral	UL Listed. CSA Certified.
Snap-In	UL Recognized. CSA Certified.

Knockout Holes

N.P.T. Hub Size	Knockout Hole Recommended Min. to Max.	
	inches	(mm)
¼	.54"-.57"	(13.7-14.5)
⅜	.67"-.70"	(17.0-17.8)
½	.86"-.91"	(21.8-23.1)

Dimensions shown are approximate and are subject to change without notice.



Snap-In

Diameter Range Inches (mm)	For Chas. Thk. (Max.) Inches (mm)	Required Hole Size		Dimensional Specifications				
		A Inches (mm)	B Inches (mm)	C Inches (mm)	D Inches (mm)	E Inches (mm)	F Inches (mm)	G Inches (mm)
.22"-.27" (5.6-6.9)	.10" (2.5)	.50" (12.7)	.45" (11.4)	.28" (7.1)	.28" (7.1)	.54" (13.7)	.12" (3.0)	1.84" (44.2)
.28"-.32" (7.1-8.1)	.10" (2.5)	.50" (12.7)	.47" (11.9)	.28" (7.1)	.33" (8.4)	.59" (15.0)	.12" (3.0)	1.84" (44.2)
.30"-.36" (7.6-9.1)	.13" (3.3)	.63" (16.0)	.55" (14.0)	.36" (9.1)	.37" (9.4)	.65" (16.5)	.14" (3.6)	2.18" (55.4)
.32"-.43" (8.1-10.9)	.13" (3.3)	.75" (19.0)	.66" (16.8)	.45" (11.4)	.44" (11.2)	.75" (19.1)	.14" (3.6)	2.60" (66.0)

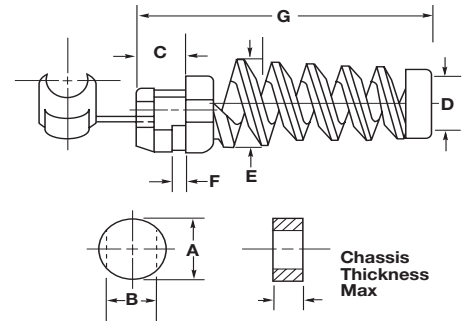

Liquidtight

F N.P.T.	A	B	C	D	E	
	Dia. Inches (mm)	Ref. Inches (mm)	Inches (mm)	Throat Dia. Inches (mm)	Across Corners Inches (mm)	Across Flats Inches (mm)
¼-18	.65" (16.5)	1.30" (33.0)	.40" (10.2)	.29" (7.4)	.65" (16.5)	.60" (15.2)
⅜-18	.81" (20.6)	1.44" (36.6)	.41" (10.4)	.36" (9.1)	.81" (20.6)	.75" (19.1)
½-14	1.00" (25.4)	1.56" (39.6)	.46" (11.7)	.45" (11.4)	.99" (25.1)	.92" (23.4)

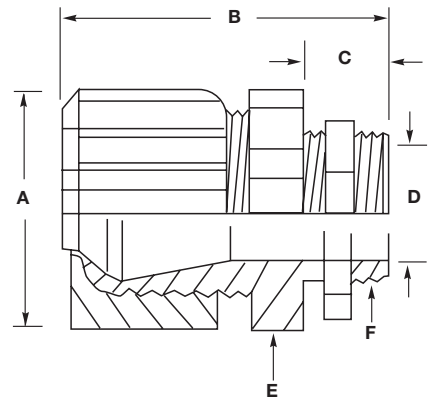

Liquidtight with Spiral

G N.P.T.	A	B	C	D	E	F	
	Dia. Inches (mm)	Ref. Inches (mm)	Inches (mm)	Throat Dia. Inches (mm)	Inches (mm)	Across Corners Inches (mm)	Across Flats Inches (mm)
¼-18	.65" (16.5)	2.55" (64.8)	.40" (10.2)	.29" (7.4)	.27" (6.9)	.65" (16.5)	.60" (15.2)
⅜-18	.81" (20.6)	3.10" (78.7)	.41" (10.4)	.36" (9.1)	.35" (8.9)	.81" (20.6)	.75" (19.1)
½-14	1.00" (25.4)	3.72" (94.5)	.46" (11.7)	.45" (11.4)	.45" (11.4)	.99" (25.1)	.92" (23.4)

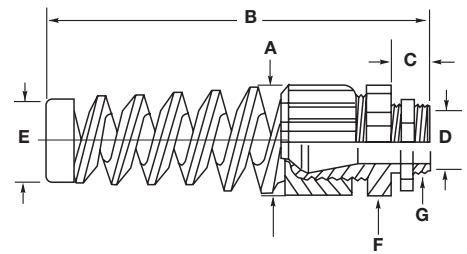

Dimensions shown are approximate and are subject to change without notice.



Kellems® Wire Management Products
PolyTuff® I Non-Metallic Liquidtight Conduit

Features and Benefits

PolyTuff® I Conduit-Gray

Rigid PVC core bonded to flexible PVC jacket

All nonmetallic construction ends metal fatigue and separation problems

UL Listed and CSA Certified

Cuts cleanly with a knife or PVC cutter so there are no jagged metal edges

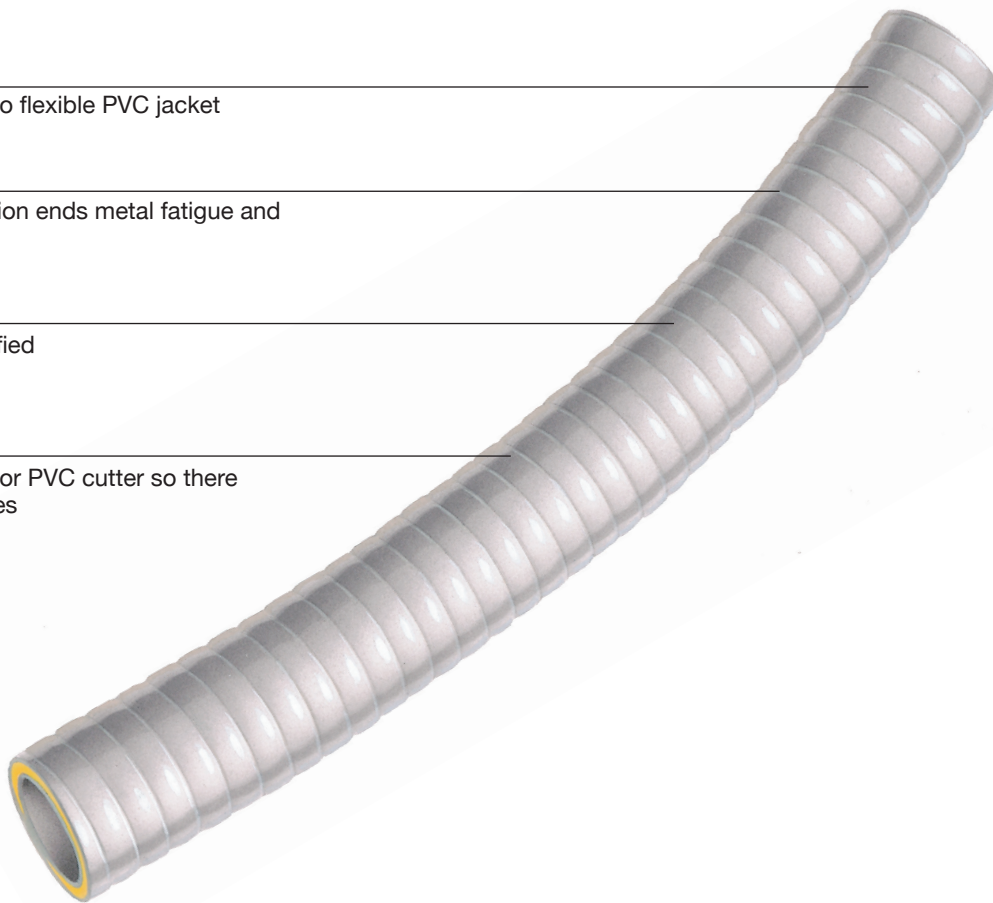

IP66
SUITABILITY

PolyTuff® I Conduit

Trade Size (metric designator)	Feet (m)	Catalog Number
3/8 (12)	100 (30.5)	G1038
1/2 (16)	100 (30.5)	G1050
3/4 (21)	100 (30.5)	G1075
1 (27)	100 (30.5)	G1100
1 1/4 (35)	100 (30.5)	G1125
1 1/2 (41)	50 (15.2)	G1150
2 (53)	50 (15.2)	G1200

Note: See pages T-68, T-69, T-107 and T-109 for approved fittings.
 See pages T-110 to T-111 for additional technical data and dimensional drawings.



Kellems® Wire Management Products
PolyTuff® II Non-Metallic Liquidtight Tubing
 Features and Benefits



PolyTuff® II Tubing-Black

PVC core with corrugated walls bonded to PVC jacket

Handles twists, turns, bends, switchbacks and straightaways with ease

All nonmetallic construction ends fatigue and separation problems

Can be cut with a knife or PVC cutters

UL Recognized and CSA Certified



IP66
SUITABILITY

PolyTuff® II Tubing

Trade Size (metric designator)	Feet (m)	Catalog Number
¼ (10)	100 (30.5)	B2025
⅜ (12)	100 (30.5)	B2038
½ (16)	100 (30.5)	B2050
¾ (21)	100 (30.5)	B2075
1 (27)	100 (30.5)	B2100
1¼ (35)	100 (30.5)	B2125
1½ (41)	50 (15.2)	B2150
2 (53)	50 (15.2)	B2200



Note: See page T-107 for approved fittings.
 See pages T-110 to T-111 for additional technical data and dimensional drawings.



Kellems® Wire Management Products **PolyTuff® Non-Metallic Liquidtight Fittings**

Features and Benefits



Nylon two-piece swivel body enables fitting to twist from 0° to 90°

Non-integral ferrule provides conduit seal and superior pullout protection

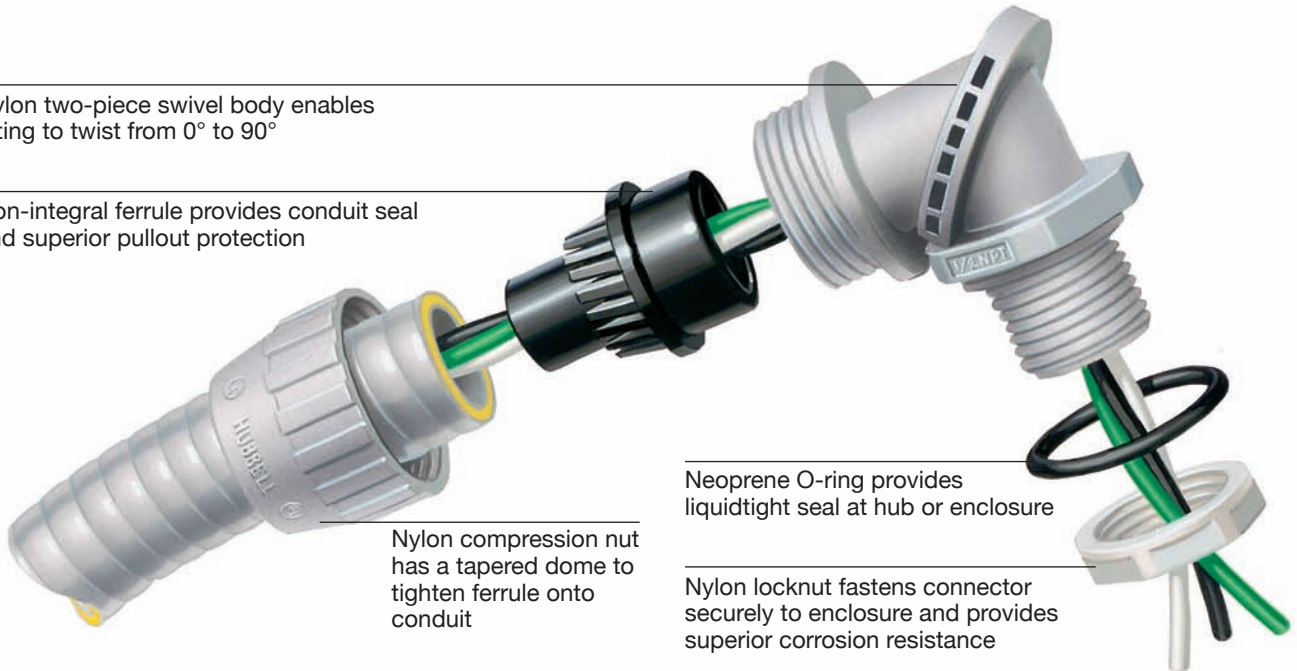

Nylon compression nut has a tapered dome to tighten ferrule onto conduit

Neoprene O-ring provides liquidtight seal at hub or enclosure

Nylon locknut fastens connector securely to enclosure and provides superior corrosion resistance

Kellems® Wire Management Products

PolyTuff® Non-Metallic Liquidtight Fittings



UL Listed to Type
4X, 12 and 13

Straight with Male Non-Metallic Liquidtight Fittings

Trade Size (metric designator)	Black Catalog Number	Gray Catalog Number
¼ (6)	F2025	—
⅜ (9)	P038NBKA	P038NGYA
½ (13)	P050NBKA	P050NGYA
¾ (19)	P075NBKA	P075NGYA
1 (25)	P100NBKA	P100NGYA
1¼ (32)	P125NBK	P125NGY
1½ (38)	P150NBK	P150NGY
2 (51)	P200NBK	P200NGY

Note: Fittings are to be used with PolyTuff I and PolyTuff II.
See page T-113 for additional technical data and dimensional drawings.
¾" Liquidtight conduit fitting have ½ N.P.T. male threads.



P075NGYA



P125NGY

SwivelLok® Multi-Position with Male Non-Metallic Liquidtight Fittings

Trade Size (metric designator)	Black Catalog Number	Gray Catalog Number
⅜ (9)	PS0389NBK	PS0389NGY
½ (13)	PS0509NBK	PS0509NGY
¾ (19)	PS0759NBK	PS0759NGY
1 (25)	PS1009NBK	PS1009NGY

Note: Fittings are to be used with PolyTuff I and PolyTuff II.
See page T-113 for additional technical data and dimensional drawings.
¾" Liquidtight conduit fitting have ½ N.P.T. male threads.



PS0509NGY - SwivelLok®

Fixed 90° Fittings for Non-Metallic Conduit

Trade Size (metric designator)	Black Catalog Number	Gray Catalog Number
¼ (6)	F20259	—
⅜ (9)	P0389NBK	P0389NGY
½ (13)	P0509NBK	P0509NGY
¾ (19)	P0759NBK	P0759NGY
1 (25)	P1009NBK	P1009NGY
1¼ (32)	P1259NBK	P1259NGY

Note: Fittings are to be used with PolyTuff I and PolyTuff II.
See page T-113 for additional technical data and dimensional drawings.
¾" Liquidtight conduit fitting have ½ N.P.T. male threads.



P1259NGY

SwivelLok® Flexible Conduit Kit

Trade Size (metric designator)	Fitting and Conduit	Catalog Number
½ (13)	2 PS0509NGY, 6' G1050	PS05GYKIT
¾ (19)	2 PS0759NGY, 6' G1075	PS07GYKIT

Note: See page T-113 for additional technical data and dimensional drawings.



PS05GYKIT



Kellems® Wire Management Products
Metallic Liquidtight Conduit Fittings

Features and Benefits

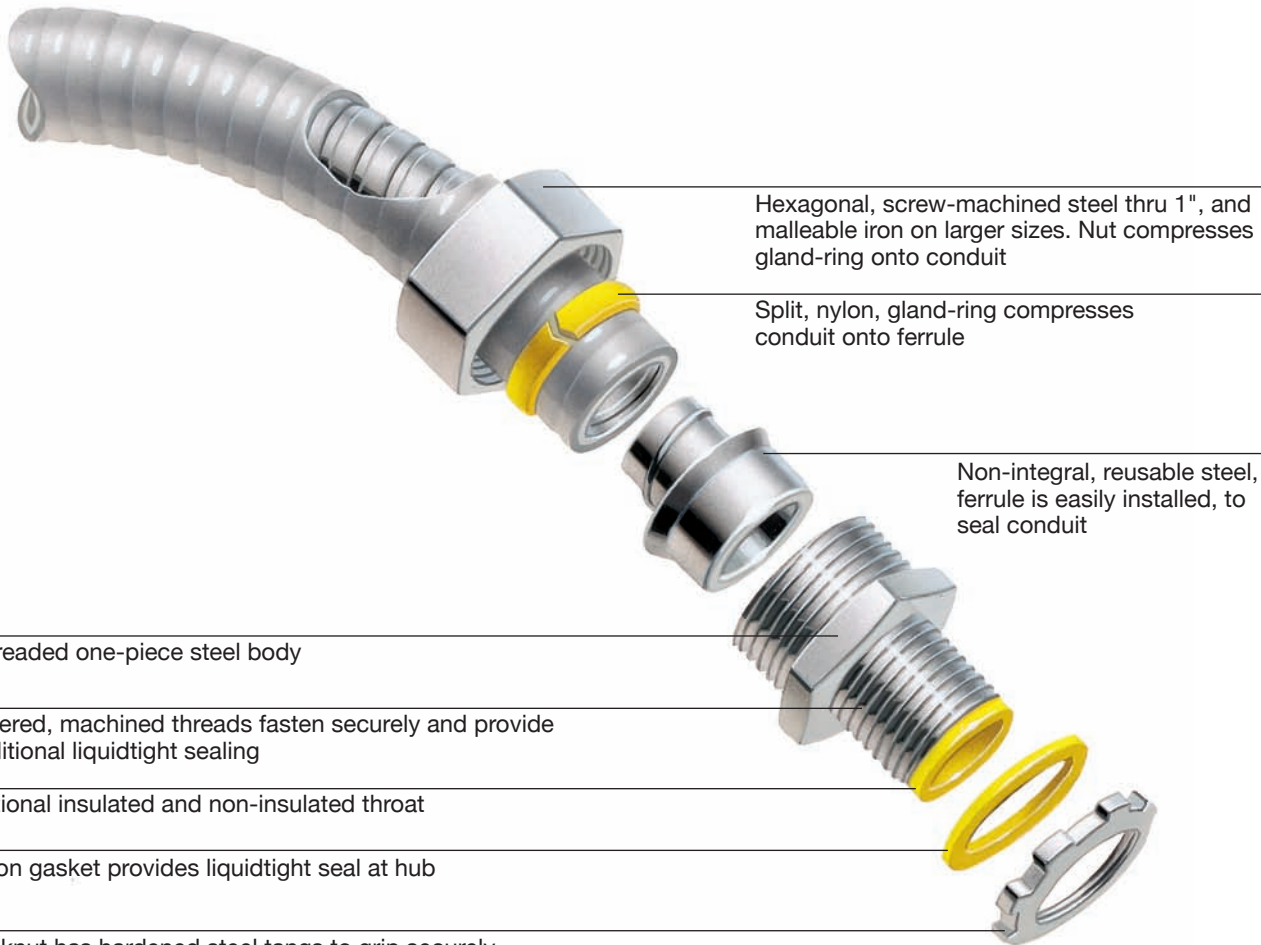
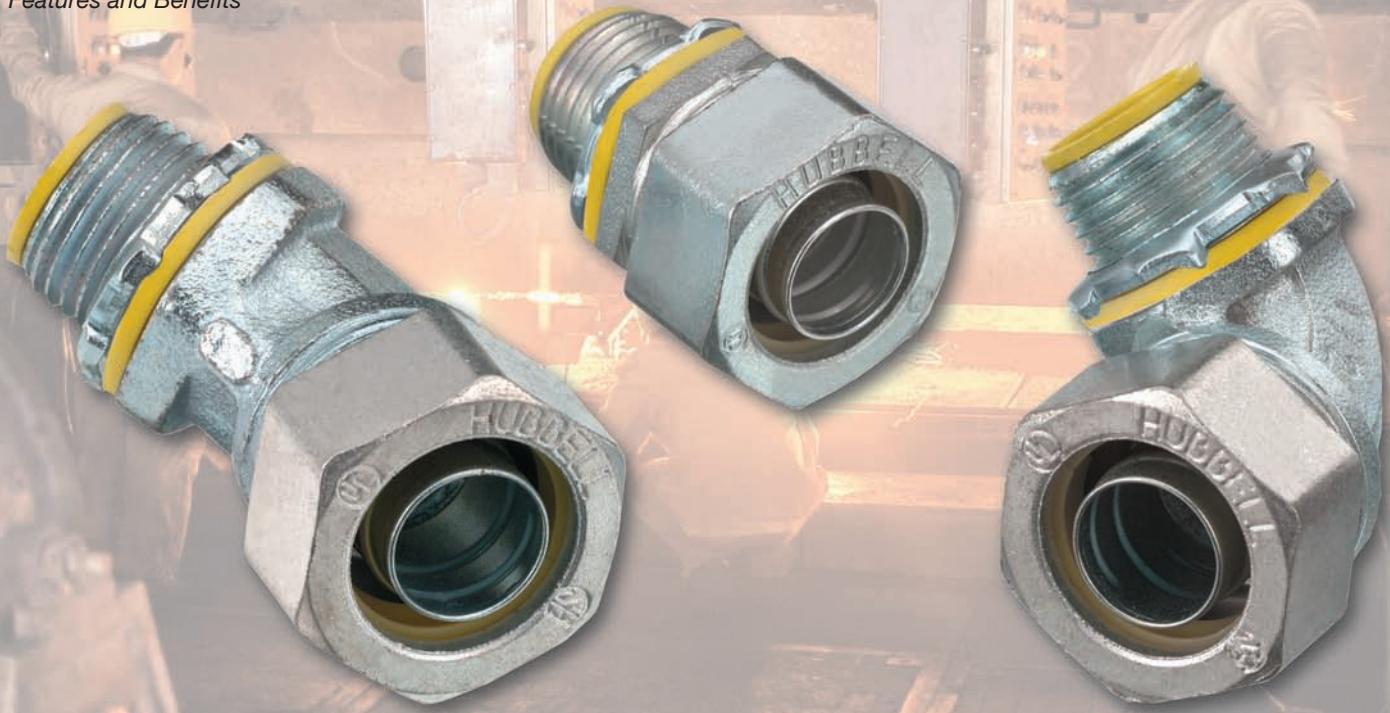

Hexagonal, screw-machined steel thru 1", and malleable iron on larger sizes. Nut compresses gland-ring onto conduit

Split, nylon, gland-ring compresses conduit onto ferrule

Non-integral, reusable steel, ferrule is easily installed, to seal conduit

Threaded one-piece steel body

Tapered, machined threads fasten securely and provide additional liquidtight sealing

Optional insulated and non-insulated throat

Nylon gasket provides liquidtight seal at hub

Locknut has hardened steel tangs to grip securely

Kellems® Wire Management Products

Metallic Liquidtight Conduit Fittings



Straight Conduit Fitting

Trade Size (metric designator)	Insulated	Non-Insulated
3/8 (9)	H0381	H038
1/2 (13)	H0501	H050
3/4 (19)	H0751	H075
1 (25)	H1001	H100
1 1/4 (32)	H1251	H125
1 1/2 (38)	H1501	H150
2 (51)	H2001	H200
2 1/2 (63)	H2501	H250
3 (76)	H3001	H300
3 1/2 (89)	H3501	H350
4 (102)	H4001	H400

Note: 3/8" Liquidtight conduit fitting have 1/2 N.P.T. male threads.
For use with Liquidtight Metal conduit and PolyTuff I Non-Metallic conduit.
See page T-114 for additional technical data.



**Straight with Male
Hubbell Conduit Fitting
H050**

45° Conduit Fitting

Trade Size (metric designator)	Insulated	Non-Insulated
3/8 (9)	H03841	H0384
1/2 (13)	H05041	H0504
3/4 (19)	H07541	H0754
1 (25)	H10041	H1004
1 1/4 (32)	H12541	H1254
1 1/2 (38)	H15041	H1504
2 (51)	H20041	H2004

Note: 3/8" Liquidtight conduit fitting have 1/2 N.P.T. male threads.
For use with Liquidtight Metal conduit and PolyTuff I Non-Metallic conduit.
See page T-114 for additional technical data.



**45° Angle with Male
Hubbell Conduit Fitting
H0504**

90° Conduit Fitting

Trade Size (metric designator)	Insulated	Non-Insulated
3/8 (9)	H03891	H0389
1/2 (13)	H05091	H0509
3/4 (19)	H07591	H0759
1 (25)	H10091	H1009
1 1/4 (32)	H12591	H1259
1 1/2 (38)	H15091	H1509
2 (51)	H20091	H2009
2 1/2 (63)	H25091	H2509
3 (76)	H30091	H3009
4 (102)	H40091	H4009

Note: 3/8" Liquidtight conduit fitting have 1/2 N.P.T. male threads.
For use with Liquidtight Metal conduit and PolyTuff I Non-Metallic conduit.
See page T-114 for additional technical data.



**90° Angle with Male
Hubbell Conduit Fitting
H0509**



Kellems® Wire Management Products

Technical Information

Non-Metallic Liquidtight Conduit and Tubing

PolyTuff I Conduit**Operating Temperature Range**

Wet environment	0°F to +140°F (-18°C to +60°C).
Oil environment	0°F to +158°F (-18°C to +70°C).
Dry environment	0°F to +176°F (-18°C to +80°C).

Certifications

UL Listed	UL Standard 1660. Sunlight resistant approved for outdoor use, direct burial.
CSA Certified	Meets requirements of NEC.

Voltage Rating

Maximum	600V.
---------	-------

Material

Conduit	Co-extruded rigid and flexible PVC.
---------	-------------------------------------

PolyTuff II Tubing**Operating Temperature Range**

Operating environment	0°F to +140°F (-18°C to +60°C).
-----------------------	---------------------------------

Certifications

UL Recognized
CSA Certified

Voltage Rating

Maximum	Same as wire insulation rating.
---------	---------------------------------

Material

Tubing	Co-extruded rigid and flexible PVC.
--------	-------------------------------------

PolyTuff I Conduit

Trade Size (metric designator)	Conduit ID/OD		Bend Radius	
	Inches	(mm)	Inches	(mm)
3/8 (12)	.49"/.70"	(12.6/17.8)	2.00"	(50.8)
1/2 (16)	.63"/.83"	(16.1/21.1)	3.00"	(76.2)
3/4 (21)	.83"/1.04"	(21.1/26.4)	4.00"	(101.6)
1 (27)	1.05"/1.30"	(26.0/33.1)	5.00"	(127.0)
1 1/4 (35)	1.40"/1.65"	(35.4/41.8)	6.30"	(158.8)
1 1/2 (41)	1.59"/1.88"	(40.3/47.8)	7.50"	(190.5)
2 (53)	2.03"/2.36"	(51.6/59.9)	10.00"	(254.0)

PolyTuff II Tubing

Trade Size (metric designator)	Conduit ID/OD		Bend Radius	
	Inches	(mm)	Inches	(mm)
1/4 (10)	.36"/.57"	(9.3/14.5)	1.50"	(38.1)
3/8 (12)	.49"/.70"	(12.6/17.8)	2.00"	(50.8)
1/2 (16)	.63"/.83"	(16.1/21.1)	2.00"	(50.8)
3/4 (21)	.83"/1.04"	(21.1/26.4)	3.00"	(76.2)
1 (27)	1.05"/1.30"	(26.0/33.1)	3.00"	(76.2)
1 1/4 (35)	1.40"/1.65"	(35.4/41.8)	5.00"	(127.0)
1 1/2 (41)	1.59"/1.88"	(40.3/47.8)	5.00"	(127.0)
2 (53)	2.03"/2.36"	(51.6/59.9)	5.00"	(127.0)



PolyTuff I and II Conduit/Tubing; PVC Chemical Resistance

Chemical	Conc*	Temp.		Chemical	Conc*	Temp.		Chemical	Conc*	Temp.	
		70°F 21°C	150°F 66°C			70°F 21°C	150°F 66°C			70°F 21°C	150°F 66°C
Acetate Solvents		D	D	Coconut Oil		C	D	Lubricating Oils		A	A
Acetic Acid		B	C	Corn Oil		A	B	Magnesium Chloride		A	A
Acetic Acid (Glacial)		C	D	Cottonseed Oil		C	D	Magnesium Hydroxide		A	A
Acetone		D	D	Creosote		D	D	Magnesium Sulfate		A	A
Acrylonitrile		A	B	Cresol		C	D	Malathion 50 in Aromatics		D	D
Alcohols (Aliphatic)		C	C	Crysylic Acid		D	D	Malic Acid		A	A
Aluminum Chloride		A	A	Cyclohexane		B	C	Methyl Acetate		D	D
Aluminum Sulfate (Alums)		A	A	DDT Weed Killer		A	C	Methyl Alcohol		C	C
Ammonia (Anhydrous Liquids)		D	D	Dibutyl Phthalate		D	D	Methyl Bromide		D	D
Ammonia (Aqueous)		A	A	Diesel Oils		C	D	Methyl Ethyl Ketone		D	D
Ammoniated Latex		A	C	Diethylene Glycol		B	C	Methylene Chloride		D	D
Ammonium Chloride		A	A	Diethyl Ether		A	C	Mineral Oil			
Ammonium Hydroxide		A	A	Di-isodecyl Phthalate		D	D	Monochlorobenzene		A	A
Amyl Acetate		D	D	Diocetyl Phthalate		D	D	Muriatic Acid (see Hydrochloric Acid)			
Aniline Oils		D	D	Dow General Weed Killer (Phenol)		D	D	Naphtha		C	D
Aromatic Hydrocarbons		D	D	Dow General Weed Killer (H ₂ O)		B	C	Naphthalene		D	D
Asphalt		D	D	Ethyl Alcohol		C	C	Nitric Acid 10%		A	B
ASTM Fuel A		C	C	Ethylene Dichloride		D	D	Nitric Acid 35%		A	C
ASTM Fuel B		D	D	Ethylene Glycol		B	C	Nitric Acid 70%		D	D
ASTM #1 Oil		B	C	Ferric Chloride		A	A	Oleic Acid		A	C
ASTM #3 Oil		C	D	Ferric Sulfate		A	A	Oleum		D	D
Barium Chloride		A	A	Ferrous Chloride		A	A	Oxalic Acid		A	A
Barium Sulfide		A	A	Ferrous Sulfate		A	A	Pentachlorophenol in Oil		B	C
Barium Hydroxide		A	A	Formaldehyde		D	D	Pentane		C	D
Benzene (Benzol)		D	D	Fuel Oil		B	C	Perchloroethylene		B	C
Benzine (Petroleum Ether)		C	C	Furfural		C	C	Petroleum Ether		C	C
Black Liquor		A	A	Gallic Acid		A	A	Phenol		A	A
Bordeaux Mixture		A	A	Gasoline (Hi Test)		C	D	Phosphoric Acid 10%		A	A
Boric Acid		A	A	Glycerine		A	A	Pitch 50%		A	B
Butyl Acetate		D	D	Grease		A	C	Potassium Hydroxide		C	D
Butyl Alcohol		B	C	Green Sulfate Liquor		A	A	Sodium Cyanide		A	A
Calcium Hydroxide		A	A	Heptachlor in Petroleum Solvents		A	C	Stoddard Solvent		D	D
Calcium Hypochlorite		A	A	Heptane		C	D	Styrene		D	D
Carbolic Acid (Phenol)		B	C	Hexane		C	D	Sulfur Dioxide (liquid)		D	D
Carbon Dioxide		A	A	Hydrobromic Acid		A	A	Sulfuric Acid 50%		A	B
Carbon Disulfide		D	D	Hydrochloric Acid 10%		A	A	Sulfuric Acid 98%		D	D
Carbon Tetrachloride		D	D	Hydrochloric Acid 40%		C	C	Sulfurous Acid		B	C
Carbonic Acid		A	A	Hydrofluoric Acid 70%		D	D	Tall Oil		D	D
Casein		A	C	Hydrofluorosilicic Acid		A	A	Tannic Acid		A	A
Caustic Soda		A	B	Hydrofluorosilicic Acid 10%		A	A	Toluene		D	D
Chlorine Gas (wet)		D	D	Hydrogen Peroxide		A	B	Trichlorethylene		D	D
Chlorine Gas (dry)		D	D	Iso-Octane		C	C	Triethanol Amine		C	D
Chlorine (water solution)		C	D	Isopropyl Acetate		D	D	Tricresyl Phosphate (Skydrol)		D	D
Chlorobenzene		D	D	Isopropyl Acid		B	C	Turpentine		C	D
Chlorinated Hydrocarbons		D	D	Jet Fuels (JP-3, and 5)		C	D	Vinegar		A	B
Chromic Acid		B	C	Kerosene		C	C	Vinyl Chloride		D	D
Citric Acid		A	A	Ketones		D	D	Water		A	A
Coal Tar		D	D	Linseed Oil		A	A	White Liquor		A	A
								Xylene		D	D
								Zinc Chloride		A	A
								Zinc Sulfate		A	A

Note: * Conc. - Concentration.
 (All ratings apply to concentrated or saturated solutions unless otherwise specified.)
 Chemical resistance ratings are based upon information supplied by the raw material manufacturers.
 Use as a general guide only – samples should be tested by user under actual conditions.

Rating Code

A-Excellent service

No harmful effect to reduce service life. Suitable for continuous service.

B-Good service life.

Moderate to minor effect. Good for intermittent service. Generally suitable for continuous service.

C-Fair or limited service.

Depends on operating conditions. Generally suitable for intermittent service. Not recommended for continuous service.

D-Unsatisfactory service.

Not recommended.





Kellems® Wire Management Products

Technical Information

Non-Metallic Liquidtight Fittings

PolyTuff Fittings**Operating Temperature***

Nylon (Body, Nut, Gripping Ring and Locknut)	-40°F to +225°F (-40°C to +107°C).
Neoprene (Sealing Ring)	-30°F to +240°F (-34°C to +116°C).

Flammability

Fire Gas Toxicity Product Testing	Nylon PolyTuff Fittings have a UL 94V-2 rating.
-----------------------------------	---

Certifications

UL Listed	UL50 Type 4X, 12 and 13.
CSA Certified	PolyTuff I Fittings, Poly Tuff II Fittings.

Liquidtight Fittings**Operating Temperature****

Steel/Malleable Iron (Nut, Body, Ferrule)	-60°F to +1000°F (-51°C to +538°C).
Nylon (Gland Ring)	-40°F to +225°F (-40°C to +107°C).

Hazardous Locations - NEC Reference

Class I, Div. 2 - 501-10(A)(3)B
 Class II, Div. 1 - 502-10(A)(2)
 Class II, Div. 2 - 502-10(A)(3)
 Class III, Div. 1 - 503-10(A)(2)
 Class III, Div. 2 - 503-10(B)

Certifications

UL Listed
 CSA Certified

Note: * Due to the limiting factors of nylon and neoprene, PolyTuff Fittings will continuously perform in the range -30°F to +225°F (-34°C to +107°C).

** Due to the limiting factors of nylon, metallic liquidtight flexible conduit fittings will continuously perform in the range of -40°F to +225°F (-40°C to +107°C).



Straight with Male Non-Metallic Liquidtight Fittings

Trade Size (md**)	A	B	C	D Throat Dia.	E	A/C*	A/F*
¼ (10)	.93" (23.6)	1.45" (36.8)	.39" (9.9)	.32" (8.1)	.86" (Dia.) (21.8)		
⅜ (12)	1.14" (29.0)	1.63" (41.4)	.57" (14.5)	.42" (10.7)	1.41" (35.8)	1.41"	1.30" (33.0)
½ (16)	1.30" (33.0)	2.14" (54.4)	.57" (14.5)	.55" (14.0)	1.41" (35.8)	1.41"	1.30" (33.0)
¾ (21)	1.53" (38.9)	2.22" (56.4)	.58" (14.7)	.74" (18.8)	1.85" (47.0)	1.85"	1.53" (38.9)
1 (27)	1.80" (45.7)	2.32" (58.9)	.72" (18.3)	.96" (24.4)	1.94" (49.3)	1.94"	1.80" (45.7)
1¼ (35)	2.20" (55.9)	2.15" (54.6)	.74" (18.8)	1.30" (33.0)	2.38" (60.5)	2.38"	2.18" (55.4)
1½ (41)	2.49" (63.2)	2.35" (59.7)	.76" (19.3)	1.46" (37.1)	2.63" (66.8)	2.63"	2.43" (61.7)
2 (53)	3.05" (77.4)	2.51" (63.6)	.79" (20.1)	1.90" (48.3)	3.13" (79.5)	3.13"	2.93" (74.4)

Note: * A/C = Across Corners A/F = Across Flats.
 ** md = metric designator.

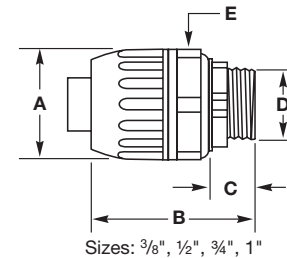
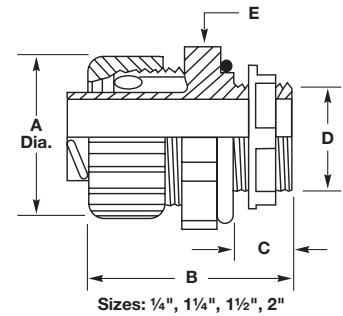

90° with Male Non-Metallic Liquidtight Fittings

Trade Size (md**)	A	B	C	D Throat Dia.	E	A/C*	A/F*
¼ (10)	.93" (23.6)	1.88" (47.8)	.39" (9.9)	.32" (8.1)	.86" (Dia.) (21.8)		
1¼ (35)	2.21" (56.1)	3.57" (90.7)	.74" (18.9)	1.30" (33.0)	2.38" (60.5)	2.38"	2.18" (55.4)

Note: * A/C = Across Corners A/F = Across Flats.
 ** md = metric designator.

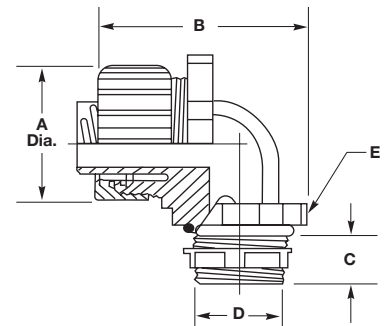

SwivelLok® Multi-Position Liquidtight Fittings

Trade Size (md**)	A	B	C	D	E	F	G	A/C*	A/F*
⅜ (12)	1.30" (33.0)	3.27" (83.1)	.57" (14.5)	.55" (14.0)	1.43" (36.3)	2.00" (50.8)	1.41" (35.8)	1.41"	1.30" (33.0)
½ (16)	1.30" (33.0)	3.27" (83.1)	.57" (14.5)	.55" (14.0)	1.43" (36.3)	2.00" (50.8)	1.41" (35.8)	1.41"	1.30" (33.0)
¾ (21)	1.53" (38.9)	3.66" (93.0)	.58" (15.7)	.74" (18.8)	1.59" (40.4)	2.23" (56.6)	1.65" (41.9)	1.65"	1.53" (38.9)
1 (27)	1.80" (45.7)	4.00" (101.6)	.72" (18.3)	.96" (24.4)	1.84" (46.7)	2.30" (58.4)	1.94" (49.3)	1.94"	1.80" (45.7)

Note: * A/C = Across Corners A/F = Across Flats.
 ** md = metric designator.

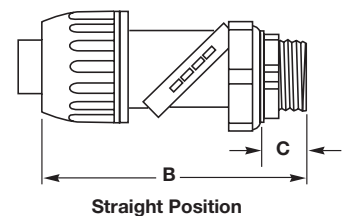
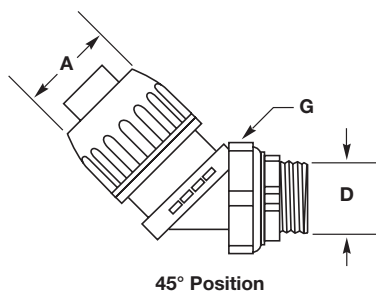
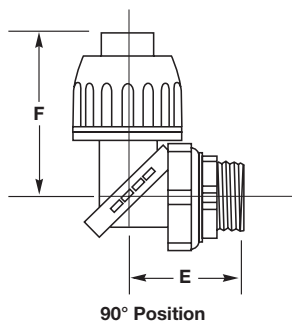



Kellems® Wire Management Products

Technical Information

Metallic Liquidtight Fittings

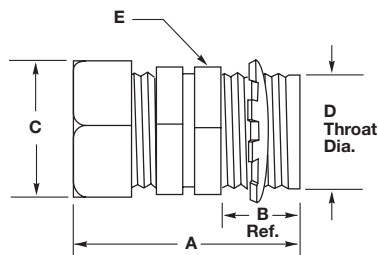

Straight with Male Metallic Metal Fitting

Trade Size (md**)	A		C		D Throat Dia.	E	
	Ref.	B	A/C*	A/F*		A/C*	A/F*
3/8 (12)	1.43" (36.3)	.59" (15.0)	1.20" (30.0)	1.06" (26.9)	.61" (15.5)	1.07" (27.2)	.93" (23.6)
1/2 (16)	1.43" (36.3)	.59" (15.0)	1.34" (34.0)	1.19" (30.2)	.61" (15.5)	1.22" (31.0)	1.06" (26.9)
3/4 (21)	1.56" (39.6)	.59" (15.0)	1.55" (39.0)	1.37" (34.8)	.84" (21.3)	1.43" (36.3)	1.25" (31.8)
1 (27)	1.68" (42.7)	.66" (16.8)	1.95" (50.0)	1.69" (42.9)	1.06" (26.9)	1.73" (43.9)	1.56" (39.6)
1 1/4 (35)	2.03" (51.6)	.63" (16.8)	2.39" (61.0)	2.06" (52.3)	1.37" (34.8)	2.36" (59.9)	2.08" (52.8)
1 1/2 (41)	2.21" (56.1)	.63" (16.8)	2.72" (69.0)	2.38" (60.5)	1.53" (38.9)	2.79" (70.9)	2.48" (63.0)
2 (53)	2.28" (57.9)	.69" (17.5)	3.08" (78.0)	2.87" (72.9)	2.06" (52.3)	3.32" (84.3)	2.90" (73.7)
2 1/2 (63)	3.56" (90.4)	1.06" (26.9)	3.92" (100.0)	3.62" (91.9)	2.42" (61.5)	3.85" (97.8)	3.60" (91.4)
3 (78)	3.81" (96.8)	1.06" (26.9)	4.70" (119.0)	4.31" (109.5)	3.01" (76.5)	4.65" (118.1)	4.33" (110.0)
3 1/2 (91)	3.81" (96.8)	1.06" (26.9)	5.29" (134.0)	4.81" (122.2)	3.49" (88.6)	5.18" (131.6)	4.82" (122.4)
4 (103)	3.81" (96.8)	1.06" (26.9)	5.75" (146.0)	5.31" (134.9)	3.96" (100.6)	5.75" (146.1)	5.39" (136.9)

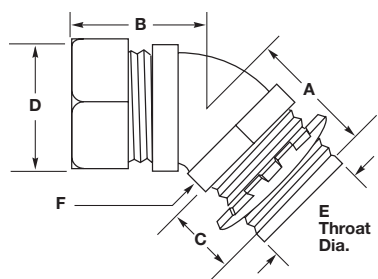

45° with Male Metallic Metal Fitting

Trade Size (md**)	A		C	D		E Throat Dia.	F	
	B	A/C*		A/F*	A/C*		A/F*	
3/8 (12)	1.19" (30.2)	1.28" (32.5)	.59" (15.0)	1.20" (30.5)	1.06" (26.9)	.60" (15.2)	1.16" (29.5)	1.02" (25.9)
1/2 (16)	1.19" (30.2)	1.28" (32.5)	.59" (15.0)	1.34" (34.0)	1.19" (30.2)	.61" (15.2)	1.21" (30.7)	1.06" (26.9)
3/4 (21)	1.19" (30.2)	1.43" (36.3)	.59" (15.0)	1.55" (39.4)	1.45" (36.8)	.84" (21.3)	1.50" (38.1)	1.32" (33.5)
1 (27)	1.38" (35.1)	1.53" (38.9)	.66" (16.8)	1.95" (49.5)	1.69" (42.9)	1.05" (26.7)	1.82" (46.2)	1.59" (40.4)
1 1/4 (35)	1.42" (36.1)	1.69" (42.9)	.63" (16.0)	2.39" (60.7)	2.06" (52.3)	1.37" (34.8)	2.32" (58.9)	2.03" (51.6)
1 1/2 (41)	1.66" (42.2)	2.00" (50.8)	.66" (16.8)	2.72" (69.1)	2.38" (60.5)	1.60" (40.6)	2.62" (66.5)	2.29" (58.2)
2 (53)	1.69" (42.9)	2.25" (57.2)	.66" (16.8)	3.08" (78.2)	2.88" (73.2)	2.05" (52.1)	3.21" (81.5)	2.80" (71.1)

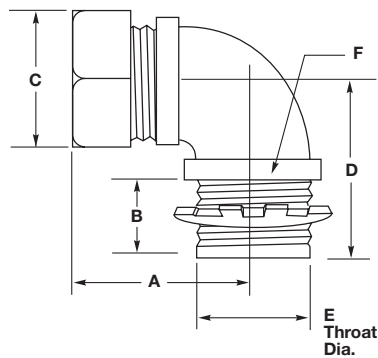

90° with Male Metallic Metal Fitting

Trade Size (md**)	A		C		D Ref.	E Throat Dia.	F	
	B	A/C*	A/F*	A/C*			A/F*	
3/8 (12)	1.31" (33.3)	.59" (15.0)	1.20" (30.5)	1.06" (26.9)	1.44" (36.6)	.60" (15.2)	1.13" (29.0)	.99" (25.1)
1/2 (16)	1.31" (33.3)	.59" (15.0)	1.34" (34.0)	1.12" (28.4)	1.44" (36.6)	.61" (15.5)	1.12" (28.0)	1.00" (25.4)
3/4 (21)	1.44" (36.6)	.59" (15.0)	1.55" (39.4)	1.45" (36.8)	1.63" (41.4)	.83" (21.1)	1.48" (38.0)	1.29" (32.8)
1 (27)	1.78" (45.2)	.59" (15.0)	1.95" (49.5)	1.60" (40.6)	2.19" (55.6)	1.05" (26.7)	1.80" (46.0)	1.57" (39.9)
1 1/4 (35)	1.97" (50.0)	.63" (16.0)	2.39" (60.7)	2.06" (52.3)	2.50" (63.5)	1.36" (34.5)	2.32" (59.0)	2.02" (51.3)
1 1/2 (41)	2.19" (55.6)	.63" (16.0)	2.72" (69.1)	2.38" (60.5)	2.69" (68.3)	1.61" (40.9)	2.58" (66.0)	2.25" (57.2)
2 (53)	2.53" (64.3)	.66" (16.8)	3.08" (78.2)	2.87" (72.9)	3.25" (82.6)	2.05" (52.1)	3.14" (80.0)	2.75" (69.9)
2 1/2 (63)	3.44" (87.4)	1.00" (25.4)	3.92" (99.6)	3.63" (92.2)	4.25" (108.0)	2.42" (61.5)	3.78" (96.0)	3.50" (88.9)
3 (78)	3.75" (95.3)	1.00" (25.4)	4.70" (119.4)	4.31" (109.5)	4.87" (123.7)	3.01" (76.5)	4.64" (118.0)	4.30" (109.2)
4 (103)	4.25" (108.0)	1.00" (25.4)	5.75" (146.1)	5.31" (134.9)	5.63" (143.0)	3.96" (100.6)	5.76" (146.0)	5.38" (136.7)

Note: * A/C = Across Corners A/F = Across Flats.
** md = metric designator.

