

DO NOT SCALE DRAWING

REVISIONS				
ZONE	REV.	DESCRIPTION	DATE	APPROVED
	A	DRAWN	13-06-2013	

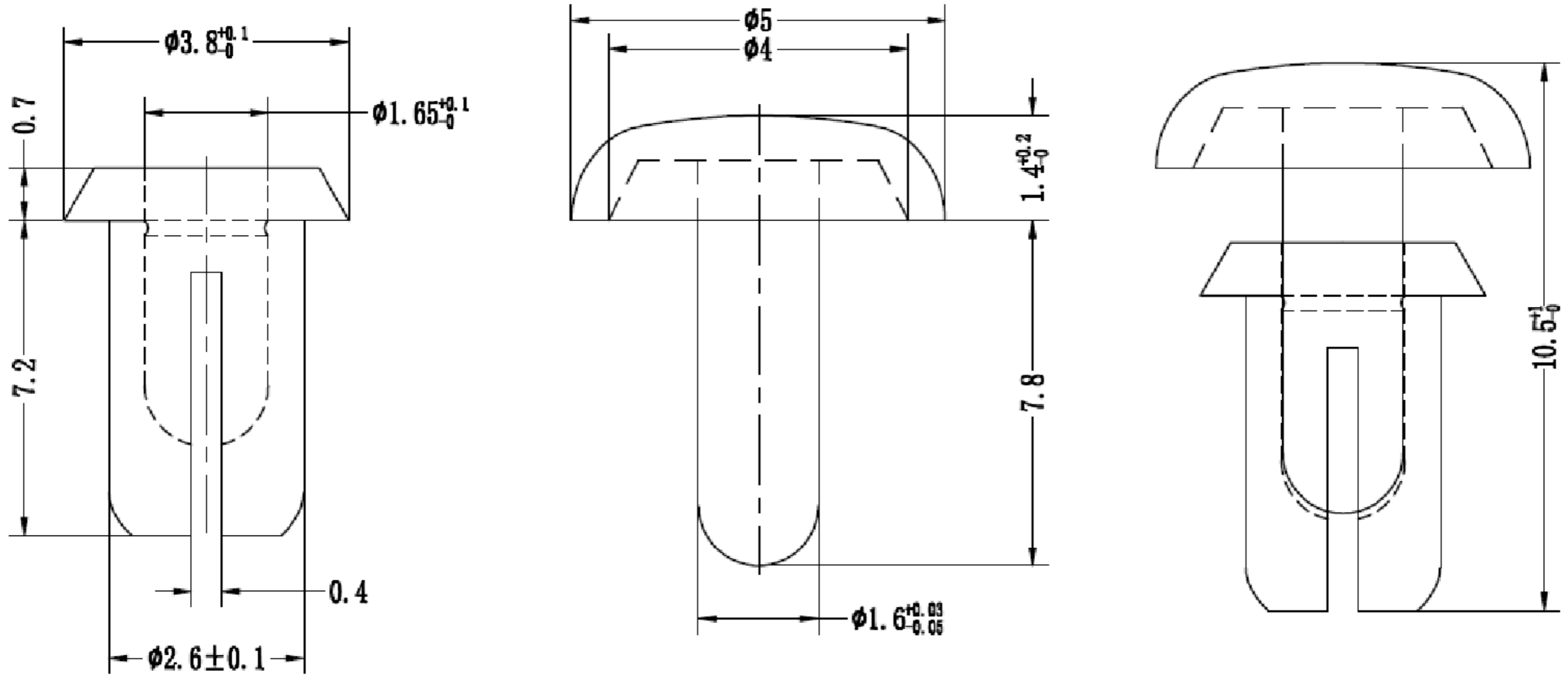

NOTES

Also available in flame retardant nylon (PA6 UL94V-0)



DESIGN RIGHT. TR FASTENINGS LTD, 2003
 UNDER NO CIRCUMSTANCES MUST THIS
 DRAWING BE COPIED OR DISCLOSED,
 WITHOUT FIRST OBTAINING WRITTEN
 AUTHORITY.

UNLESS OTHERWISE SPECIFIED:
 DIMENSIONS ARE IN MILLIMETERS.
 SURFACE FINISH:
 TOLERANCES:
 L ≤ 4 = ±0,1 4 < L ≤ 15 = ±0,2
 15 < L ≤ 50 = ±0,3 50 < L ≤ 100 = ±0,4

	NAME	DATE
DRAWN	DANIELE MONTALI	13/06/2013
CHK'D		
APPV'D		

MATERIAL
 PA6 UL94V-2
 ROHS compliant

HEAT TREATMENT
 N/A

FINISH
 Black or White

TITLE
 Snap Rivet

DWG NO.
TRSR2672

A3