

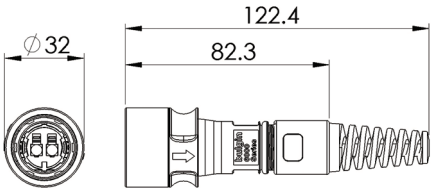







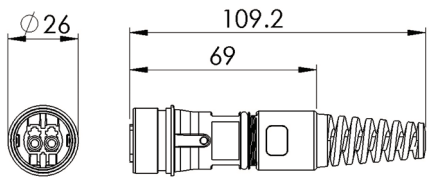

- Sealed to IP66 IP68 and IP69K when mated
- IP68 rating tested at 1.054kg/sq cm (15lb/sq in) 10m depth for 2 weeks
- Duplex LC-Type Interface
- Cabled Versions: 0S1, 0M1, 0M3
- Cable range from 5 to 450M
- Diameter over coupling ring 32.0mm
- Flex, Flex In-Line and Rear Panel
- Secure, proven locking system
- 30° twist locking. Tamperproof lock prevents accidental un-mating
- All plastic body version; UL94-V0 rated, UV stable, halogen free Light-weight, self-extinguishing material suitable for long-term outdoor use.
- Sealing caps available to maintain IP68 rating
- EN60068-2-52 Test Kb Salt Mist (Cyclic) Marine Severity Level 1

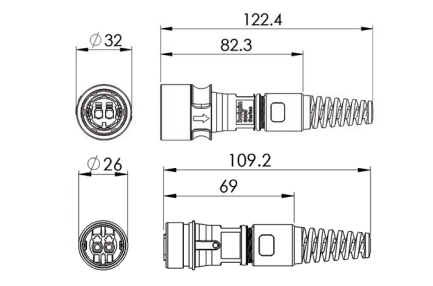
 <p>PXF6050XXX</p>	<ul style="list-style-type: none"> ○ Patchcords with IP68 connectors ○ Available in 5 - 450m lengths ○ Supplied with LC fiber plug ○ 0S1, 0M1 or 0M3 cable options <p>*Fiber assignment on page 6</p>	
 <p>PXF6051XXX</p>	<ul style="list-style-type: none"> ○ Patchcords with IP68 connectors ○ Available in 5 - 450m lengths ○ Supplied with LC fiber plug ○ 0S1, 0M1 or 0M3 cable options <p>*Fiber assignment on page 6</p>	
 <p>PXF6054XXX</p>	<ul style="list-style-type: none"> ○ Patchcords with IP68 connectors ○ Available in 5 - 450m lengths ○ Supplied with LC fiber plug ○ 0S1, 0M1 or 0M3 cable options <p>*Fiber assignment on page 6</p>	
 <p>PXF6055XXX</p>	<ul style="list-style-type: none"> ○ Patchcords with IP68 connectors ○ Available in 5 - 450m lengths ○ Supplied with LC fiber plug ○ 0S1, 0M1 or 0M3 cable options <p>*Fiber assignment on page 6</p>	
<p>Rear Panel Mounting Connector</p>  <p>PXF6052XXX</p>	<ul style="list-style-type: none"> ○ LC fiber adapter ○ Leaded with LC connector ○ Socket variant mates with PXF6050 type connectors <p>*Fiber assignment on page 6</p>	

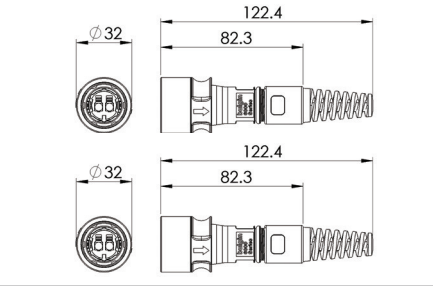
Flex Cable Connector

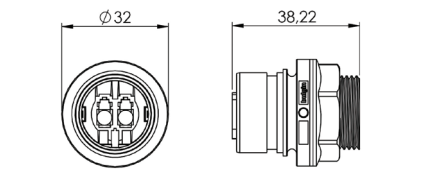

PXF6050X

- Mates with Flex In-Line or Panel mounting versions PXF6051, PXF6053
- 30° turn locking ring
- Supplied without LC Connectors

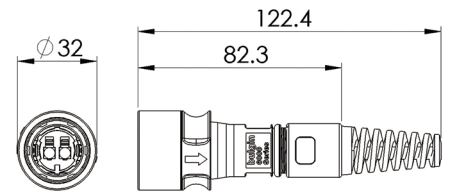

In-Line Flex Cable Connector



PXF6051X

- Mates with Flex Cable connector PXF6050
- For In-Line connection
- Supplied without LC Connectors

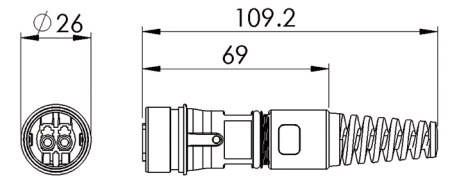

Rear Panel Mounting Connector



PXF6052X

- Mates with Flex Cable connector PXF6050
- Rear Panel Mounting
- Single hole fixing
- Supplied without LC Connectors

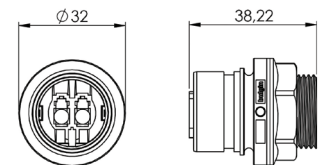

Sealing Caps



- Sealing caps to maintain IP rating when connectors are not in use
- PXP6081 for cable connectors PXF6050.
- PXP6083 for front panel mount connectors PXF6052 & PXF6051, with 30° twist lock

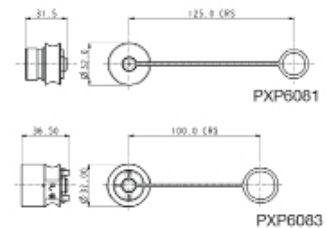

Part No.

Description

PXP6081	Sealing Cap for Flex cable connectors (PXF6050)
PXP6083	Sealing Cap for front panel mounting connector (PXF6052, PXF6051)

Cables & connectors

Mechanical

Sealing	IP69K, DIN40050-9 IP68, EN60529:1992+A2:2013 (10m depth for 2 weeks) IP66, EN60529:1992+A2:2013 1.0 - 1.1NM (91lb.in)
Panel Mount Nut	1.0 - 1.1NM (91lb.in)
Operating temperature	-25°C to +70°C
Salt Mist	EN60068-2-52 Test Kb Salt Mist (Cyclic) Marine Severity Level 1

Material:

Flex and panel types:	Polyamide
Body Mouldings:	UL94v-0
Flammability Rating:	To EN 500021:1999
UV Resistance:	
Cable Outer Jacket:	Polyethylene for UV and Weather Resistance
O Rings:	Silicone
Panel Sealing O Ring:	Silicone

Optical

IEC 61753-1	
Max Insertion Loss	0.2db } single mode
AVG Insertion Loss	0.1db } single mode

RoHS Compliant

Fiber Specification - SECTION OSI

Item	Detail	Specification		
Fiber type	/	G.657A2 (OS1)		
	Wavelength	1310nm		
Mode field diameter	Range of nominal values	8.6µm -9.5µm		
	Tolerance	±0.4 µm		
Cladding diameter	Nominal	125.0µm		
	Tolerance	±0.7 µm		
Core concentricity error		≤0.5µm		
Cladding non-circularity		≤1%		
Coating diameter	Nominal	245µm		
	Tolerance	±10µm		
Coating-cladding concentricity error		≤12.5µm		
Cut-off wavelength		≤1260 nm		
Uncabled fiber macrobending loss	Radius(mm)	15	10	7.5
	Number of turns	10	1	1
	Max. at 1550nm(dB)	0.03	0.1	0.5
	Max. at 1625 nm (dB)	0.1	0.2	1.0
Min. proof stress		0.69 GPa		
Dynamic fatigue parameter		≥20		
	λ0min	1300 nm		
Chromatic dispersion coefficient	λ0max	1324 nm		
	S0max	0.092 ps/nm2 ×km		
Other parameters meet standard	ITU-T G.657			

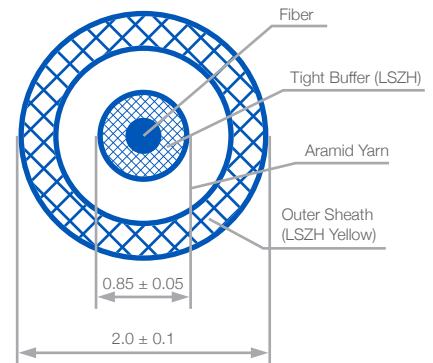

Optical Cable Specification

Structure Parameter

Tight buffer	Material	Polyolefin (POE)
	Outer diameter	0.85mm±0.05mm
Strength member	Material	Aramid yarn
Outer sheath	Sheath material	Polyolefin (POE)
	Sheath color	Yellow(Pantone 136C) Chromatic aberration E: ≤4.0
	Min. sheath thickness	0.3mm
	Dimension	2.0mm±0.1mm

Transmission Performance

Attenuation coefficient	Wavelength 1310nm~1625nm	≤0.4 dB/km
	Maximum at 1383 nm ±3 nm	≤0.4 dB/km
	Wavelength 1550nm	≤0.3 dB/km
Macrobending loss	Radius(mm)	15 10 7.5
	Number of turns	10 1 1
	Max. at 1550 nm(dB)	0.03 0.1 0.5
	Max. at 1625 nm (dB)	0.1 0.2 1.0

Other performances

Min. bending radius of work	10mm
Other parameter meet standard	IEC60794-2-50, YD/T1258.2, ITU-T G.657

Fiber Specification - SECTION OMI

Item	Detail	Specification
Fiber type	/	62.5/125(A1b) (OM1)
Core diameter	Normal value	62.5 μm
	Tolerance	$\pm 3 \mu\text{m}$
Cladding diameter	Nominal	125.0 μm
	Tolerance	$\pm 2 \mu\text{m}$
Core-cladding concentricity error		$\leq 3 \mu\text{m}$
Cladding non-circularity		$\leq 2\%$
Core non-circularity		$\leq 6\%$
Primary coating diameter (uncoloured)	Nominal	245 μm
	Tolerance	$\pm 10 \mu\text{m}$
Primary coating-cladding concentricity error		$\leq 12.5 \mu\text{m}$
Uncabled fiber macrobending loss	Radius(mm)	37.5
	Number of turns	100
	At wavelengths 850 nm and 1300nm (dB)	0.5
Min. proof stress		0.69 GPa
Dynamic fatigue parameter		≥ 20
Minimum modal bandwidth- length Product for overfilled launch	Wavelength 850 nm	200 MHzkm
	Wavelength 1300 nm	500 MHzkm
Other parameters meet standard	IEC 60793-2-10	

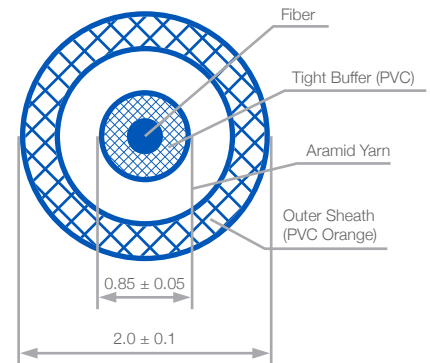
**Optical Cable Specification**

Item	Specification
Structure Parameter	
Tight buffer	Material: Polyolefin (POE) Outer diameter: 0.85mm \pm 0.05mm
Strength member	Material: Aramid yarn
Outer sheath	Sheath material: Polyolefin (POE)
	Sheath color: Orange(Pantone 164C) Chromatic aberration E: ≤ 4.0
	Min. sheath thickness: 0.3mm
	Dimension: 2.0mm \pm 0.1mm
Transmission Performance	
Attenuation coefficient	Wavelength 850m: $\leq 3.5 \text{ dB/km}$
	Wavelength 1300nm: $\leq 1.5 \text{ dB/km}$
Other performances	
Min. bending radius of work	30mm
Other parameter meet standard	IEC60794-2-50, YD/T1258.2

Fiber Specification - SECTION OM3

Item	Detail	Specification
Fiber type	/	50/125(OM3)
Core diameter	Normal value	50 μm
	Tolerance	$\pm 2.5 \mu\text{m}$
Cladding diameter	Nominal	125.0 μm
	Tolerance	$\pm 2 \mu\text{m}$
Core-cladding concentricity error		$\leq 3 \mu\text{m}$
Cladding non-circularity		$\leq 2\%$
Core non-circularity		$\leq 6\%$
Primary coating diameter (uncoloured)	Nominal	245 μm
	Tolerance	$\pm 10 \mu\text{m}$
Primary coating-cladding concentricity error		$\leq 12.5 \mu\text{m}$
Uncabled fiber macrobending loss	Radius(mm)	15 7.5
	Number of turns	2 2
	Max. at 850 nm (dB)	0.1 0.2
	Max. at 1300 nm (dB)	0.3 0.5
Min. mode bandwidth	Overfilled launch bandwidth at 850nm	1500 MHz. km
	Overfilled launch bandwidth at 1300nm	500 MHz. km
	Effective laser launch bandwidth at 850nm	2000 MHz. km
Min. proof stress		0.69 GPa
	Dynamic fatigue parameter	≤ 20
Chromatic dispersion coefficient	$\lambda 0_{\text{min}}$	1295 nm
	$\lambda 0_{\text{max}}$	1340 nm
Other parameters meet standard	$S 0_{\text{max}}(\text{from } 1295\text{nm} \leq \lambda 0 \leq 1310\text{nm})$	0.105 ps/nm ² × km
	$S 0_{\text{max}}(\text{from } 1310\text{nm} \leq \lambda 0 \leq 1340\text{nm})$	0.000375(1590- $\lambda 0$) ps/nm ² × km

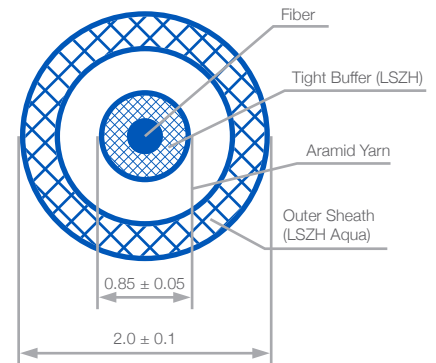
**Optical Cable Specification**

Item	Specification
Structure Parameter	
Tight buffer	Material: Polyolefin (POE) Outer diameter: 0.85mm \pm 0.05mm
Strength member	Material: Aramid yarn
Outer sheath	Sheath material: Polyolefin (POE)
	Sheath color: Aqua(Pantone 3248C) Chromatic aberration E: ≤ 4.0
	Min. sheath thickness: 0.3mm
	Dimension: 2.0mm \pm 0.1mm
Transmission Performance	
Attenuation coefficient	Wavelength 850m: ≤ 3.5 dB/km
	Wavelength 1300nm: ≤ 1.5 dB/km
Macrobending loss	Radius (mm): 15 7.5
	Number of turns: 2 2
	Max. at 850 nm (dB): 0.1 0.2
	Max. at 1300 nm (dB): 0.3 0.5
Other performances	
Min. bending radius of work	10mm
Other parameter meet standard	IEC60794-2-50, YD/T1258.2



PXF605 x	/	X	/	XX
<p>Body Styles</p> <p>PXF6050 PXF6051 PXF6052 PXF6054 PXF6055</p>		<p>For Cable Type</p> <p>A = OM3 (Multimode) B = OM1 (Multimode) C = OS1 (Single Mode)</p>		<p>Contact Type</p> <p>Blank = No cable AA = 1 (1M on chassis version only PXF6052)</p> <p>AA = 5 AB = 10 AC = 15 AD = 25 AE = 50 AF = 100 AG = 150 AH = 200 AJ = 300 AK = 450</p>

Examples:

- PXF6050A = Flex connector, for OM3 (Multimode) no cable supplied
- PXF6050AAA = Flex connector, OM3 multimode cable, 5 metre length to LC type connector
- PXF6052BAA = Panel mount connector, OM1 multi mode cable, 1 metre length to LC type connector

Fiber Assignment:

