

PLEASE CHECK WWW.MOLEX.COM FOR LATEST PART INFORMATION

Part Number: [1731110063](#)
Status: **Active**
Overview: [FCT D-Sub Connectors](#)
Description: FCT Metal Backshell for D-Sub Connector, Shell Size 4, 45° Angle Large Diameter Cable Outlet, with Locking Screws

Documents:

[RoHS Certificate of Compliance \(PDF\)](#)

General

Product Family	D-Sub Products
Series	173111
Datasheet Order No	987652-0064
Exclude SD Check	Yes
Overview	FCT D-Sub Connectors
Product Category	Backshell
Product Name	FCT Products
Type	Rugged Metal
UPC	889056487634

Physical

Cable Diameter	12.00-15.00mm
Material - Backshell	Zinc Die-cast
Material - Bushing	TPE
Material - Screw	Steel
Mounting Style	Locking Screw
Net Weight	97.300/g
Orientation	45° Angle
Packaging Type	Carton
Plating - Backshell	Nickel
Shield Type	Solid Metal
Shielded	Yes
Temperature Range - Operating	-35° to +100°C
Thread Size	4-40 UNC
Thread Type	Standard
Tightening Test Torque	40 Ncm
Waterproof / Dustproof	No

Material Info

Engineering Number	FMK4-K201
--------------------	-----------

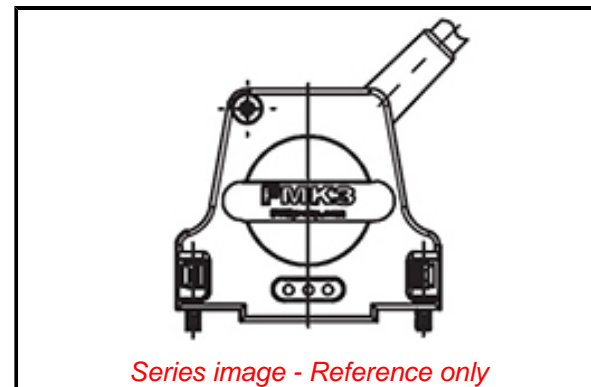

Series image - Reference only

EU ELV

Not Relevant

EU RoHS

Compliant with Exemption 6(a)-I

REACH SVHC

Not Reviewed

Halogen-Free

Status

Not Reviewed

For more information, please visit [Contact US](#)

China ROHS

50 Image

ELV

Not Relevant

RoHS Phthalates

Not Contained

Search Parts in this Series

[173111 Series](#)

Use With

FCT D-Sub, Size 4