

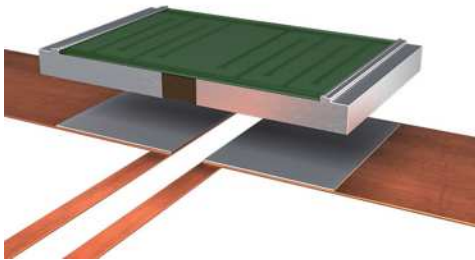

ISA-PLAN® // PRECISION RESISTORS



SMP // Size 2010



Features

- 3 W power rating at 70 °C
- Constant current up to 24 A (5 mOhm)
- Excellent long-term stability
- High pulse power rating
- Mounting: Reflow-, and IR-soldering
- AEC-Q200 qualified
- RoHS 2011/65/EU compliant



Applications

- Current sensor for power hybrid applications
- Control systems for the automotive market
- Power modules
- Frequency converters
- Switch mode power supplies

Technical data

Resistance values	Ohm	0.005 to 1 *
Tolerance	%	0.5 / 1 *
Temperature coefficient (20-60 °C)	ppm/K	<50
Applicable temperature range	°C	-65 to +170
Power rating P_{110°C}	W	2
Power rating P_{70°C}	W	3
Internal heat resistance (R _{thi})	K/W	<30
Dielectric withstanding voltage	V AC/DC	200
Inductance	nH	<3
Stability (at rated power) deviation after 2000h		<0.5% (T _k = 80 °C)
T _k = Terminal temperature		<1.0% (T _k = 110 °C)

* For detailed information see table on page 3

Ordering code

SMP - R005 - 1.0

- Tolerance
- Resistance value [Ohm] / "R" represents decimal point
- Type



SMP // Size 2010

Recommended solder profile

Reflow- and IR-soldering

Temperature	°C	260	255	217
Time	sec	peak	40	90

Slight deformations during soldering do not affect technical properties of the component.

Tape and reel information

Specification	DIN EN 60286-3		
Tape width	mm	12	
Reel size	inch	13	
Parts per reel	pcs	10,000	
Packaging weight	g	453	

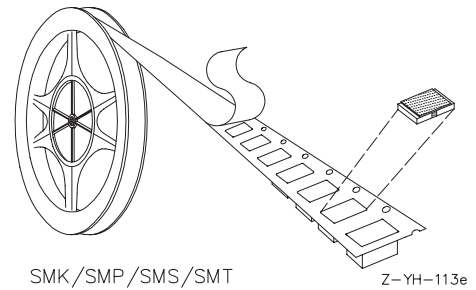

Power derating curve at 70 °C

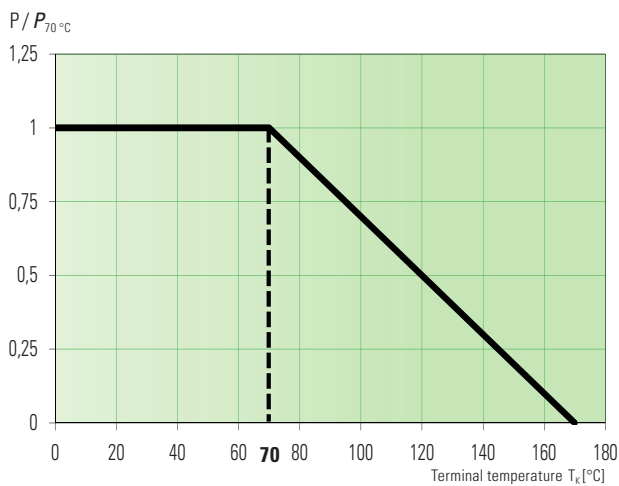

Power derating curve

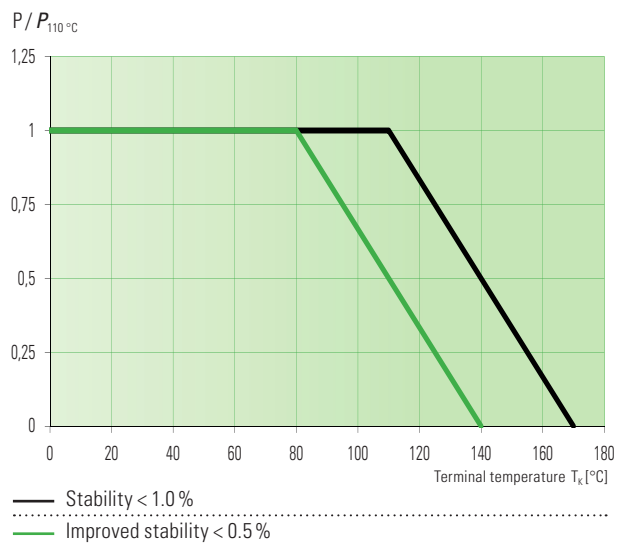

Temperature dependence of the electrical resistance of SMP resistors

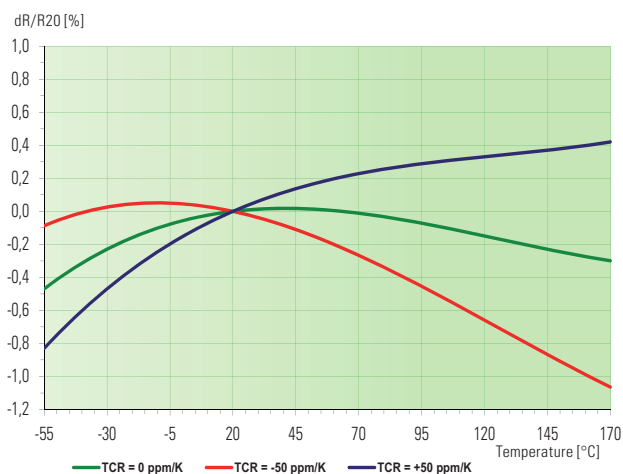



SMP // Size 2010

Mechanical dimensions and pcb-layout proposal (Reflow-soldering) [mm]

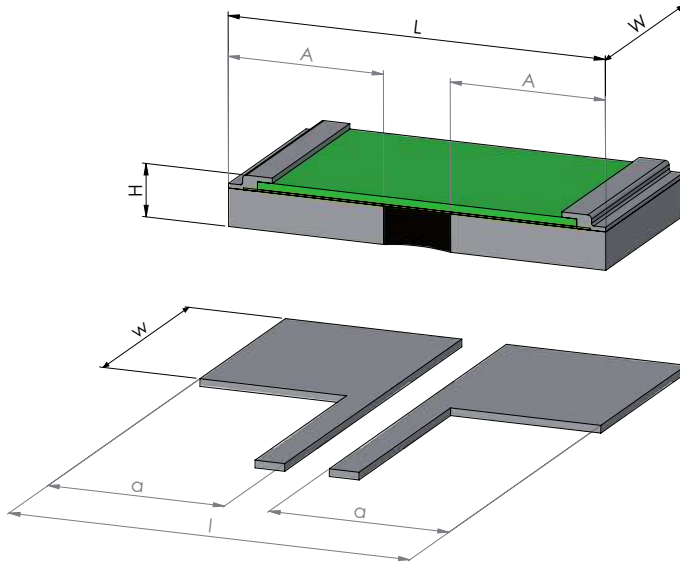

type:	L	W	A	H
SMP	5.08 ± 0.1	2.54 ± 0.1	(2.14)	0.7 ± 0.2

solder pad type:	l	w	a
SMP	5.4	2.8	2.4

Available resistance values and tolerances*

Resistance values	Tolerance	
	0.5	1.0
R005		✓
R010		✓
R015		✓
R018		✓
R020	✓	✓
R022		✓
R025		✓
R027		✓
R033	✓	✓
R039		✓
R047		✓
R050		✓

Resistance values	Tolerance	
	0.5	1.0
R068		✓
R082		✓
R100		✓
R150		✓
R160		✓
R180		✓
R200	✓	✓
R330		✓
R390		✓
R470		✓
R500		✓
1R00	✓	✓

* Further values and tolerances on request
 ✓ = available



SMP // Size 2010

Maximum pulse energy respectively pulse power for permanent operation

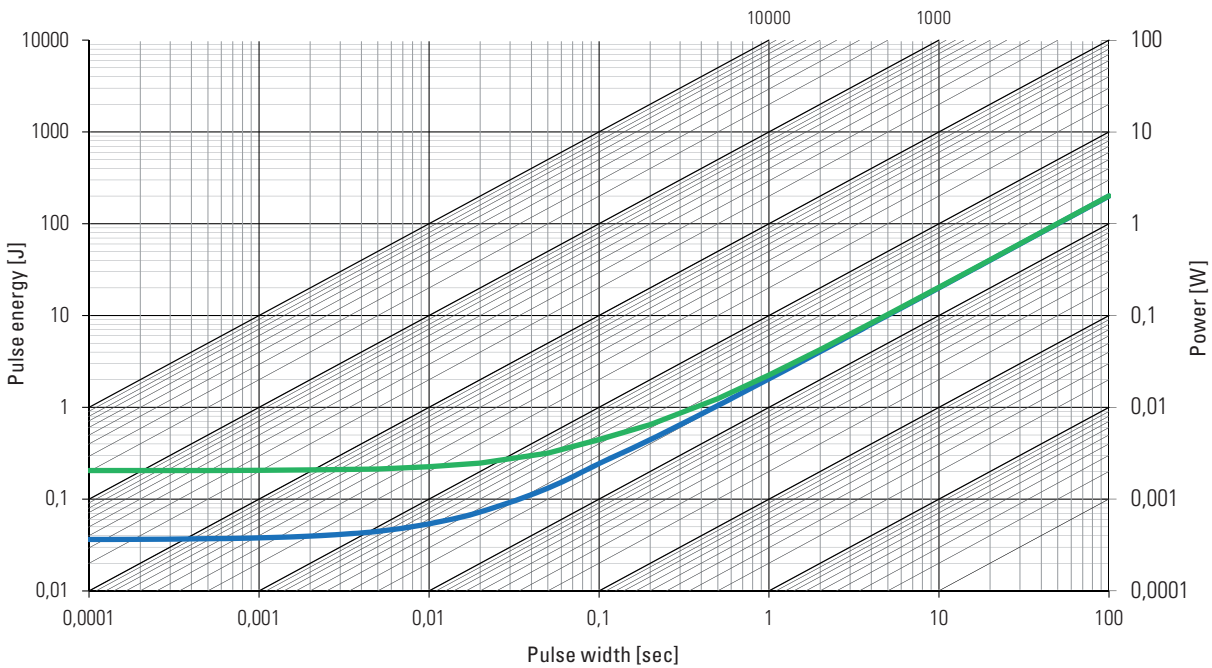

— This curve is only valid for the resistance value R005
 — This curve is only valid for the resistance value 1R00

Specification

Parameters	Test conditions	Specified values
Temperature Cycling	2000 cycles (-55 °C to +150 °C)	±0.5%
Low Temperature Storage and Operation	-65 °C for 250 h	±0.1%
Resistance to Soldering Heat	260 °C for 10 sec / 8h steam aging	±0.3%
Moisture Resistance	MIL-STD-202 method 106	±0.2%
Mechanical Shock	100 g, 6 ms half sine	±0.1%
Vibration, High Frequency	10 g, 10-2000 Hz, 24 h each axis	±0.1%
Operational Life	2000 h, T _k max at rated power	±1.0%
High Temperature Exposure	2000 h / 170 °C	±1.0%
Bias Humidity	+85 °C, 85 r.F., 1000 h	±0.5%

Disclaimer // All products, product specifications and data are subject to change without notice.

The product specifications do not expand or otherwise modify Isabellenhütte's terms and conditions of sale, including but not limited to, the warranty expressed therein. Isabellenhütte makes no warranty, representation or guarantee other than as set forth in its terms and conditions of sale. Information provided in datasheets and/or specifications may vary from actual results in different applications. Any statements made by Isabellenhütte regarding the suitability of products for certain types of applications are based on its knowledge of typical requirements that are often placed on its products. It is the customer's responsibility to validate that a particular product with the properties described in the product specification is suitable for use in the application intended.

No license, express or implied, or otherwise, to any intellectual property rights is granted by this document.

Any and all liability arising out of the application or use of any product shall be as set forth in Isabellenhütte's terms and conditions of sale.

