

CKT NO	PART NO	DIM A
2	170001-0102	8.35
4	170001-0104	12.05
6	170001-0106	17.75
8	170001-0108	23.45 ^{+0.40} _{-0.25}
10	170001-0110	29.15 ^{+0.40} _{-0.25}
12	170001-0112	34.85 ^{+0.40} _{-0.25}

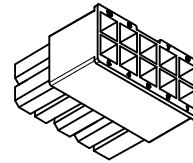

170001-0110

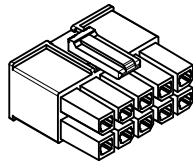
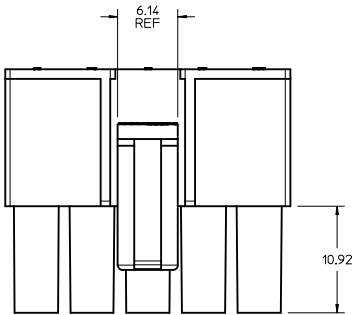
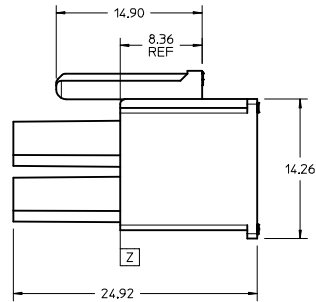
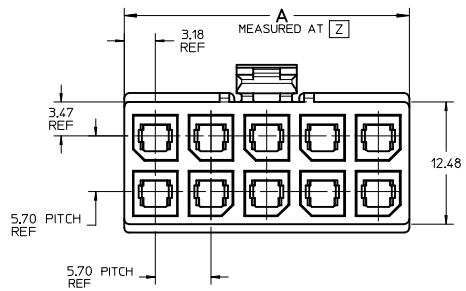

NOTES:

1. MATERIAL:
HOUSING: NYLON, UL94V-2, GLOW WIRE CAPABLE PER IEC-60335-1 5TH EDITION, COLOR: BLACK.
2. FINISH: NOT APPLICABLE.
3. PRODUCT SPECIFICATION PS-76823-100.
4. PACKAGING BULK PACK PER PK-170001-001.
5. PART MATES WITH MOLEX SERIES NUMBER 76825, 172064, 76829 AND 172065.
6. PART IS FOR USE WITH MOLEX FEMALE TERMINALS 76823 OR 172063 SERIES.
7. APPLICATION SPECIFICATION: AS-76823-100.
8. PARTS CONFORM TO CLASS 'B' REQUIREMENTS OF COSMETIC SPECIFICATION PS-45499-002 WITH THE EXCEPTION OF DISCOLORATION MEETS CLASS 'C' REQUIREMENTS.

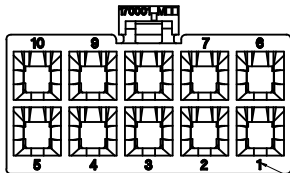
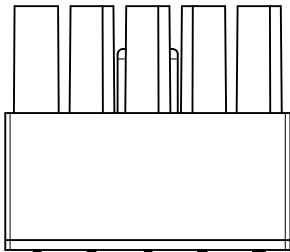

CIRCUIT #

UPDATE NOTES IEC NO: UCP2014-5278 DRAWN: DFOX 2014/06/17 CHKD: BELL 2014/06/17 APPR: F SMITH 2014/06/23	QUALITY SYMBOLS ▽=0 ▽=0 ▽=0	GENERAL TOLERANCES (UNLESS SPECIFIED)		DIMENSION STYLE MM ONLY		SCALE 4:1	DESIGN UNITS METRIC	THIRD ANGLE PROJECTION	
		4 PLACES ±--- ±---	3 PLACES ±--- ±---	2 PLACES ±0.25 ±---	1 PLACE ±--- ±---	0 PLACE ± ±	DRAWN BY MKARADIMAS	DATE 2010/11/23	TITLE MEGA-FIT RECEPTACLE HOUSING 2-12 CKT GLOW WIRE
		ANGULAR ±1/2°		DRAFT WHERE APPLICABLE MUST REMAIN WITHIN DIMENSIONS		APPROVED BY APATEL		DATE 2012/06/13	MATERIAL NO. SEE CHART
		DOCUMENT NO. SD-170001-0100		SHEET NO. 1 OF 2		THIS DRAWING CONTAINS INFORMATION THAT IS PROPRIETARY TO MOLEX INCORPORATED AND SHOULD NOT BE USED WITHOUT WRITTEN PERMISSION			

20 19 18 17 16 15 14 13 12 11 10 9 8 7 6 5 4 3 2 1

2 CKTS

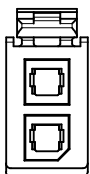

4 CKT

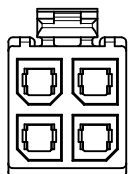

6 CKT

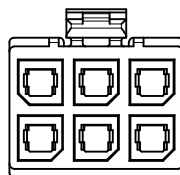

8 CKT

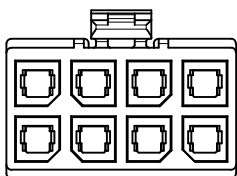

10 CKTS

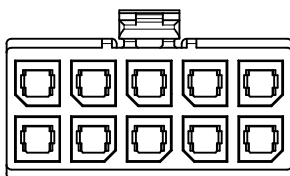

12 CKTS

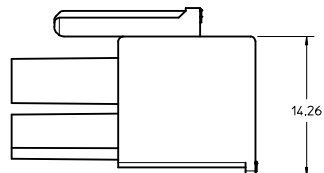
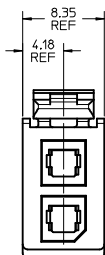
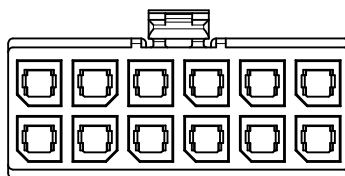

170001-0102

SEE SHT 1 IEC NO: UCP2014-5278 DRAWN: JDFOX 2014/06/17 CHKD: J.BELL 2014/06/17 APPR: F.S.MITH 2014/06/23 A9 REV DESCRIPTION	QUALITY SYMBOLS ▽=0 ▽=0 ▽=0		GENERAL TOLERANCES (UNLESS SPECIFIED) <table border="1"> <thead> <tr> <th></th> <th>mm</th> <th>INCH</th> </tr> </thead> <tbody> <tr> <td>4 PLACES</td> <td>±---</td> <td>±---</td> </tr> <tr> <td>3 PLACES</td> <td>±---</td> <td>±---</td> </tr> <tr> <td>2 PLACES</td> <td>±0.25</td> <td>±---</td> </tr> <tr> <td>1 PLACE</td> <td>±---</td> <td>±---</td> </tr> <tr> <td>0 PLACE</td> <td>±</td> <td>±</td> </tr> </tbody> </table>			mm	INCH	4 PLACES	±---	±---	3 PLACES	±---	±---	2 PLACES	±0.25	±---	1 PLACE	±---	±---	0 PLACE	±	±	DIMENSION STYLE MM ONLY		SCALE 4:1		DESIGN UNITS METRIC		THIRD ANGLE PROJECTION	
		mm	INCH																											
	4 PLACES	±---	±---																											
	3 PLACES	±---	±---																											
2 PLACES	±0.25	±---																												
1 PLACE	±---	±---																												
0 PLACE	±	±																												
DRAWN BY MKARADIMAS			DATE 2010/11/23			TITLE MEGA-FIT RECEPTACLE HOUSING 2-12 CKT GLOW WIRE																								
CHECKED BY APATEL			DATE 2012/06/13			MATERIAL NO. SEE CHART																								
DRAFT WHERE APPLICABLE MUST REMAIN WITHIN DIMENSIONS			ANGULAR ±1/2°			DOCUMENT NO. SD-170001-0100		SHEET NO. 2 OF 2																						

19 18 17 16 15 14 13 12 11 10 9 8 7 6 5 4 3 2 1

CKT NO	PART NO	DIM A
2	171692-0102	8.35
4	171692-0104	12.05
6	171692-0106	17.75
8	171692-0108	23.45 +0.40
10	171692-0110	29.15 +0.40
12	171692-0112	34.85 +0.40

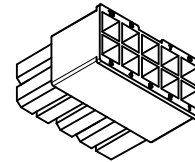
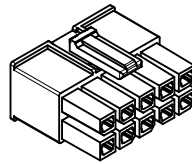
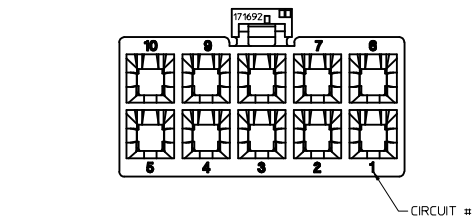
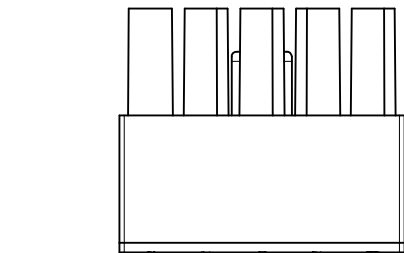
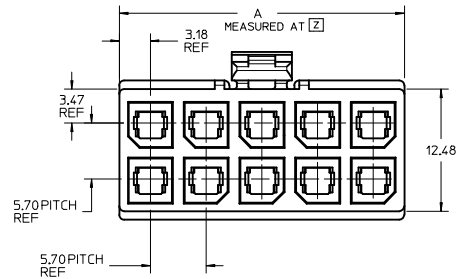
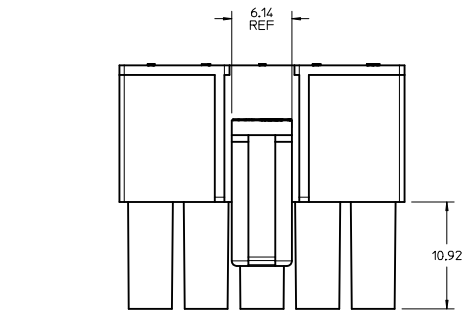

171692-0110

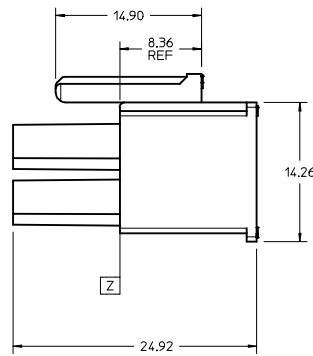

NOTES:

- MATERIAL:
HOUSING: PBT, UL 94V-0, COLOR: BLACK.
- FINISH: NOT APPLICABLE.
- PRODUCT SPECIFICATION: PS-76823-100.
- PACKAGING: BULK PACK PER PK-170001-001
- PART MATES WITH MOLEX SERIES NUMBERS 76825, 76829, 172064, AND 172065.
- PART IS FOR USE WITH MOLEX FEMALE TERMINAL 76823 OR 172063 SERIES.
- APPLICATION SPECIFICATION: AS-76823-100.
- PARTS CONFORM TO CLASS B REQUIREMENTS OF COSMETIC SPECIFICATION PS-45499-002 WITH THE EXCEPTION OF DISCOLORATION MEETS CLASS "C" REQUIREMENTS.

UPDATE NOTE 7		QUALITY SYMBOLS		GENERAL TOLERANCES (UNLESS SPECIFIED)		DIMENSION STYLE		SCALE		DESIGN UNITS		THIRD ANGLE PROJECTION	
LEC NO: UCP2014-5278	2014/06/17	DRWN: DFOX	2014/06/17	CHKD: BELL	2014/06/17	APPR: F SMITH	2014/06/23	MM ONLY	4:1	METRIC			
DRAWN BY				DATE				TITLE					
MKARADIMAS				2012/08/01				MEGA-FIT RECEPTACLE HOUSING 2-12 CKT					
CHECKED BY				DATE									
A. PATEL													
APPROVED BY				DATE									
APATEL				2012/08/17									
MATERIAL NO.				DOCUMENT NO.									
SEE CHART				SD-171692-0100									
SIZE D				THIS DRAWING CONTAINS INFORMATION THAT IS PROPRIETARY TO MOLEX INCORPORATED AND SHOULD NOT BE USED WITHOUT WRITTEN PERMISSION									
SHEET NO.		1 OF 2											

20 19 18 17 16 15 14 13 12 11 10 9 8 7 6 5 4 3 2 1

2 CKTS

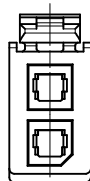

4 CKT

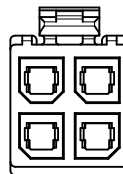

6 CKT

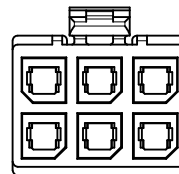

8 CKT

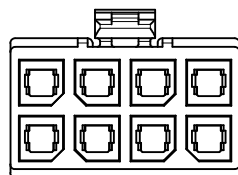

10 CKTS

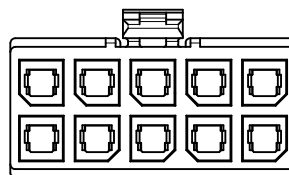

12 CKTS

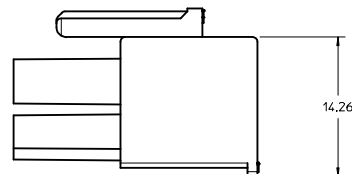
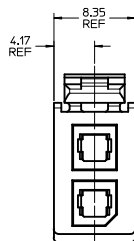
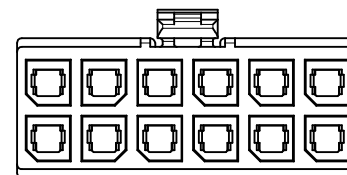

171692-0102

SEE SHT 1 IEC NO: UCPC2014-5278 DRAWN: JDFOX CHECKED: BELLE APPR: FSWITH 2014/06/17 2014/06/17 2014/06/17	QUALITY SYMBOLS ▽=0 ▽=0 ▽=0	GENERAL TOLERANCES (UNLESS SPECIFIED)		DIMENSION STYLE MM ONLY	SCALE 4:1	DESIGN UNITS METRIC	THIRD ANGLE PROJECTION
		4 PLACES ±--- ±--- 3 PLACES ±--- ±--- 2 PLACES ±0.25 ±--- 1 PLACE ±--- ±--- 0 PLACE ±--- ±---	mm INCH ±--- ±--- ±--- ±--- ±--- ±--- ±--- ±---	DRAWN BY MKARADIMAS DATE 2012/08/01	CHECKED BY DATE A. PATEL	TITLE MEGA-FIT RECEPTACLE HOUSING 2-12 CKT	
DRAFT WHERE APPLICABLE MUST REMAIN WITHIN DIMENSIONS		ANGULAR ±1/2°		MATERIAL NO. SEE CHART	APPROVED BY DATE APATEL 2012/08/17	DOCUMENT NO. SD-171692-0100	SHEET NO. 2 OF 2
THIS DRAWING CONTAINS INFORMATION THAT IS PROPRIETARY TO MOLEX INCORPORATED AND SHOULD NOT BE USED WITHOUT WRITTEN PERMISSION							

19 18 17 16 15 14 13 12 11 10 9 8 7 6 5 4 3 2 1