

KRT18BM

Multicolor contrast sensor

en 01-2016/06 50133230

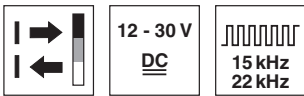

13mm



- Easy to adjust through display of the signal strength on the device
- RGB transmitter
- Maximum packing quality through short response time
- Automatic luster suppression
- Remote control via IO-Link or control cable
- Blocking of all operational controls via IO-Link or control cable
- Multiple teach modes in one device
- Automatic threshold tracking through tracking function

We reserve the right to make changes • DS_KRT18BM_5_IOLink_en_50133230.fm



Accessories:

(available separately)

- Mounting systems (BTU 200M..., BT 95)
- Mounting adapter for standard design (80 mm x 53 mm x 30 mm) BTX 018M
- Cable with M12 connector (K-D M12...)
- USB IO-Link Master SET US2-IL1.1

Dimensioned drawing

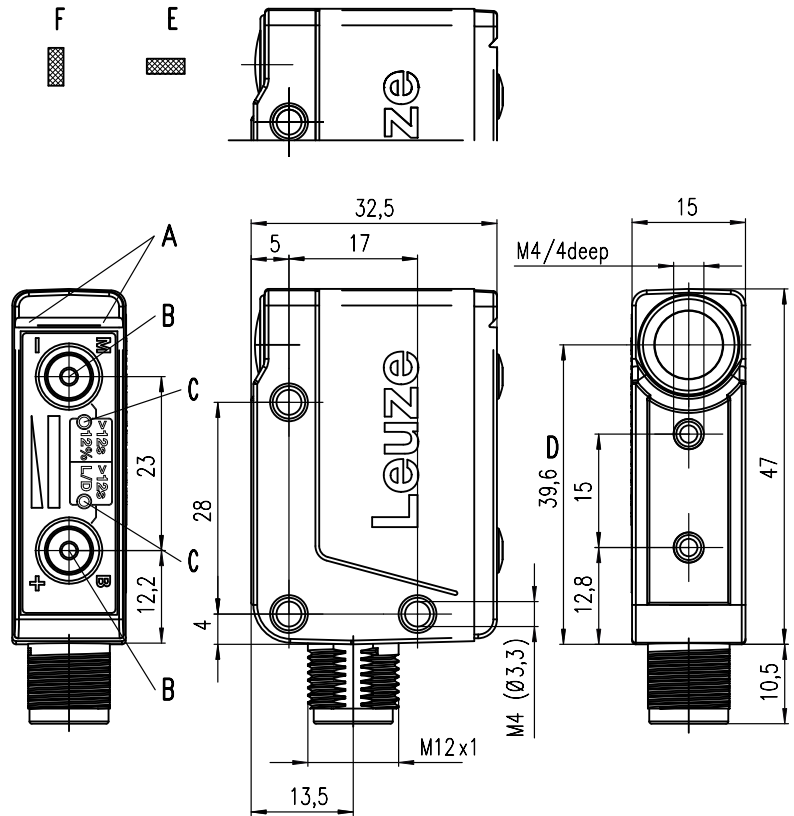

- A** Indicator diodes
- B** Teach buttons
- C** Display of the special functions
- D** Optical axis
- E** Horizontal light spot orientation (transverse)
- F** Light spot orientation vertical (lengthwise)

Electrical connection

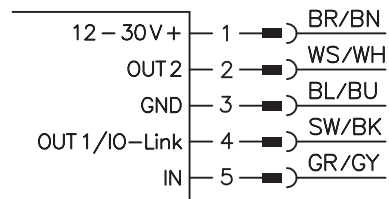

Technical data

Optical data

Scanning range	13 mm ± 3 mm
Light source ¹⁾	LEDs (red, green, blue)
Light spot dimensions	1 mm x 4 mm (at a distance of 13 mm)
Light spot orientation	Vertical (lengthwise) or horizontal (transverse)

Timing

Switching frequency	speed models KRT18BM...S...: 22 kHz	other models: 15 kHz
Response time	speed models KRT18BM...S...: 22,5 μs	other models: 33 μs
Conveyor speed (during dyn. 2-point teach)	≤ 0.1 m/s (with 1 mm mark width)	
Readiness delay	< 300 ms	

Electrical data

Operating voltage U_B ²⁾	SIO mode: 12 ... 30VDC (incl. residual ripple)	COM2 mode: 18 ... 30VDC (incl. residual ripple)
Residual ripple	≤ 15% of U_B	
Open-circuit current	25 mA (at 24V)	
Switching outputs/functions	OUT1	push-pull switching output, IO-Link SIO mode, changeover-capable
	OUT2	push-pull switching output, adjustable
Signal voltage high/low	≥ ($U_B - 2V$) / ≤ 2V	
Output current	max. 100 mA	
Input	IN	teach input and blocking of the operational controls
IO-Link	COM2 (38.4kBaude), version 1.1, min. cycle time 2.3ms, SIO is supported	
Dual Channel	yes (parallel IO-Link communication and fast switching output OUT2 is supported)	

Indicators

Green LED continuous light	ready
Yellow LED continuous light	mark detected
Green and yellow LED flashing (2Hz)	teach-in active
Green and yellow LED flashing (8Hz)	teaching error
Bar graph	reception signal strength, 13-level
Yellow LEDs - special functions	position of the switching threshold, light/dark switching, tracking

Mechanical data

Housing	diecast zinc, chemically nickel-plated
Connector	diecast zinc, chemically nickel-plated
Optics	PMMA
Operation	2 teach buttons for mark (M) and background (B)
Weight	60 g
Connection type	M12 connector, 5-pin

Environmental data

Ambient temp. (operation/storage)	-40°C ... +60°C / -40°C ... +70°C
Protective circuit ³⁾	2, 3
VDE safety class ⁴⁾	III
Degree of protection	IP67, IP 69K
Light source	exempt group (in acc. with EN 62471)
Standards applied	IEC 60947-5-2
Certifications	UL 508, C22.2 No.14-13 ²⁾ ⁵⁾
Chemical resistance	tested in accordance with ECOLAB

Additional functions

Full control of the application	13-level bar graph signal display on the device
2 teach processes	static teach on background and mark
	dynamic teach on background and mark
	can be activated via control buttons
	can be activated via control buttons
Light/dark switching (L/D)	can be activated via control buttons
Threshold close to the mark	
Tracking function for automatic signal tracking	
Warning output	signals if the tracking function can no longer readjust the sensitivity
Pulse stretching	configurable via IO-Link

1) Average life expectancy 100,000h at an ambient temperature of 25°C
 2) For UL applications: use is permitted exclusively in Class 2 circuits according to NEC
 3) 2=polarity reversal protection, 3=short circuit protection for all transistor outputs
 4) Rating voltage 50V
 5) These proximity switches shall be used with UL Listed Cable assemblies rated 30V, 0.24A min, in the field installation, or equivalent (categories: CYJV/CYJV7 or PVVA/PVVA7)

Notes

Observe intended use!

⚠ This product is not a safety sensor and is not intended as personnel protection.
 ⚠ The product may only be put into operation by competent persons.
 ⚠ Only use the product in accordance with its intended use.

- **Glossy objects:**
 With glossy objects, the sensor is to be fastened at an inclination of approx. 10° ... 15° relative to the object surface.

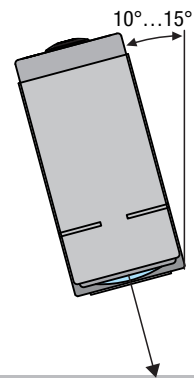

- **Alignment aid:**
 An alignment aid is included in the scope of delivery of each sensor. This facilitates simple alignment of the sensor to the working distance of 13 mm without needing to perform electrical commissioning.

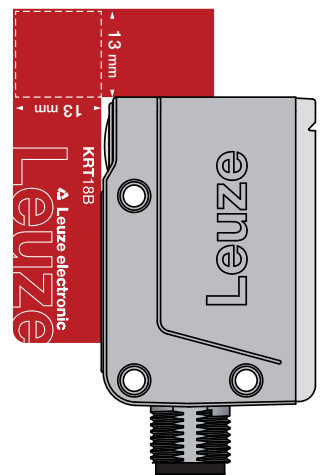

KRT18BM

Multicolor contrast sensor

Part number code

K	R	T	1	8	B	M	.	H	S	5	/	L	6	T	-	M	1	2
---	---	---	---	---	---	---	---	---	---	---	---	---	---	---	---	---	---	---

Operating principle

KRT Contrast sensor

Series

18B 18B series

Light source

M Multicolor RGB

Light spot orientation

H Horizontal (transverse)

V Vertical (lengthwise)

Additional function

S Speed, 25?kHz switching frequency

T Tracking function for automatic signal tracking

N/A Without additional function, switching frequency 15 kHz

Setting

5 Teach-in with bar graph signal indicator

Pin assignment of connector pin 4 / black cable wire (OUT1/IO-Link)

L Push-pull switching output in SIO operation, PNP active on mark, NPN active on background, IO-Link communication

Pin assignment of connector pin 2 / white cable wire (OUT2)

6 Push-pull switching output, PNP active on background, NPN active on mark

Pin assignment of connector pin 5 / gray cable wire (IN)

T Teach input

Connection technology

M12 M12 connector, 5-pin

Order guide

The sensors listed here are preferred types; current information at www.leuze.com

Order code	Part no.	Features
KRT18BM.V5/L6T-M12	50130950	Light spot orientation vertical (lengthwise), selectable additional function: switching threshold near mark, light/dark switching
KRT18BM.H5/L6T-M12	50131241	Light spot orientation horizontal (transverse), selectable additional function: switching threshold near mark, light/dark switching
KRT18BM.VT5/L6T-M12	50131242	Light spot orientation vertical (lengthwise), selectable additional function: switching threshold near mark, tracking function
KRT18BM.HT5/L6T-M12	50131243	Light spot orientation horizontal (transverse), selectable additional function: switching threshold near mark, tracking function
KRT18BM.VS5/L6T-M12	50131244	Light spot orientation vertical (lengthwise), speed model with 25kHz switching frequency, selectable additional function: switching threshold near mark, light/dark switching
KRT18BM.HS5/L6T-M12	50131245	Light spot orientation horizontal (transverse), speed model with 25kHz switching frequency, selectable additional function: switching threshold near mark, light/dark switching
Accessories		
BTX 018M	50133412	Mounting adapter for mounting on mounting devices for sensors in the standard design (80 mm x 53 mm x 30 mm)

Mounting adapter BTX 018M

With the help of mounting adapter BTX 018M (part no. 50133412), contrast sensors KRT18B... can be mounted on existing mounting devices for contrast sensors in the standard design (80mm x 53mm x 30mm).

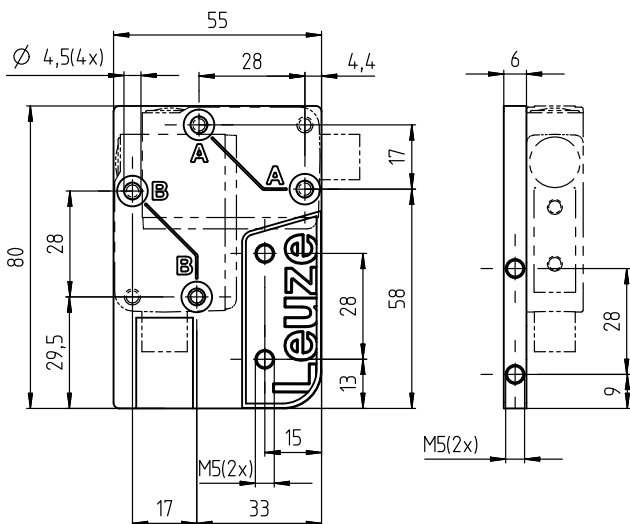

Sensor setting via teach button

Static 2-point teach

Suitable for manual positioning of the marks.

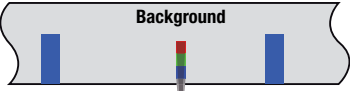
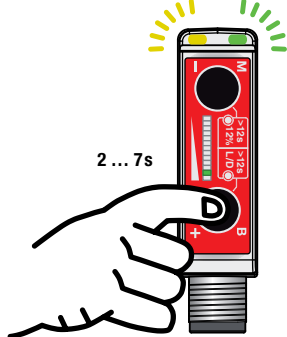
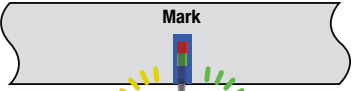
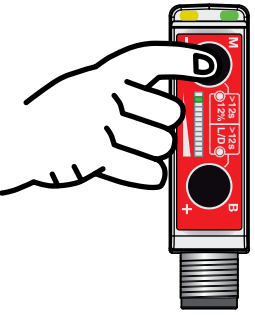
<p>Position the background.</p> 	<p>Press the B button (background) for 2 ... 7s and release.</p>  <p>2 ... 7s</p> <p>Value for background is accepted. LEDs flash synchronous (2Hz).</p>	<p>Position the mark.</p> 	<p>Briefly press the M button (mark) and release.</p>  <p>Value for mark is accepted. Sensor in RUN mode.</p> <p>In the event of a teaching error (insufficient contrast between background and mark), the LEDs flash rapidly (8 Hz). Press button again to reset.</p>
--	---	---	---

i The static 2-point teach can be performed in the reverse order in an analogous manner (first teach the mark).



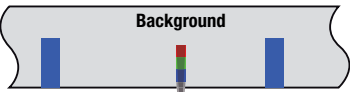
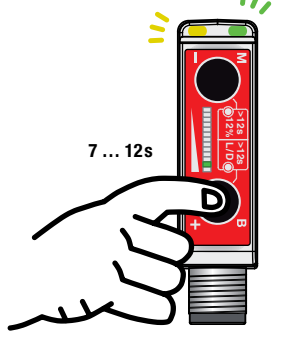
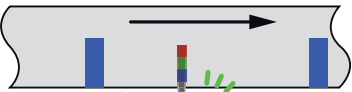
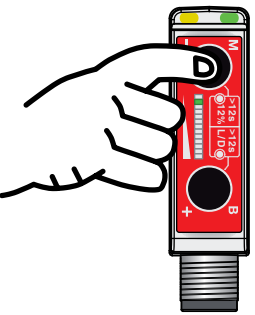

Dynamic 2-point teach

Suitable for applications in which the mark can be positioned under the light spot only with great effort.

<p>Position the background.</p> 	<p>Press the B button (background) button for 7 ... 12s and release.</p>  <p>7 ... 12s</p> <p>Measurement window opens. LEDs flash alternately (2Hz).</p>	<p>Allow marks to pass through dynamically.</p> 	<p>Briefly press the M button (mark) and release.</p>  <p>Measurement window closes. Sensor in RUN mode.</p> <p>In the event of a teaching error (insufficient contrast between background and mark), the LEDs flash rapidly (8 Hz). Press button again to reset.</p>
--	--	---	--

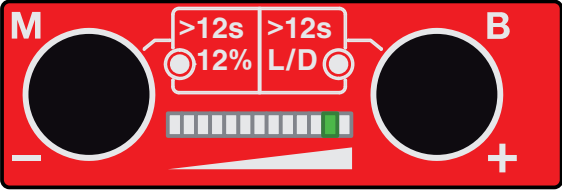
Signal strength indicator

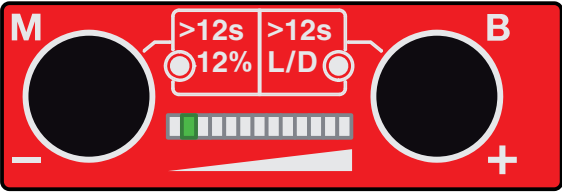
The detection reliability can easily be monitored and optimized via the bar graph display integrated in the device.

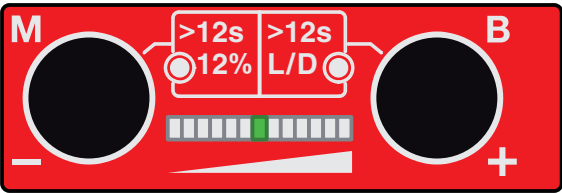
<p>High signal (e.g., bright background):</p> 	<p>LED Q1 off:</p> 
<p>Low signal (e.g., dark mark):</p> 	<p>LED Q1 on:</p> 
<p>Set switching point:</p> 	<p>The sensor is set optimally if the maximum and minimum signal are symmetric about the switching point.</p>

Fine tuning the switching threshold

The KRT18B... contrast sensor enables fine adjustment of the switching threshold to optimally adapt the sensor to the application.

 The fine adjustment should be performed only after a teach-in.

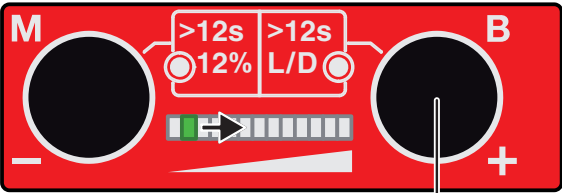
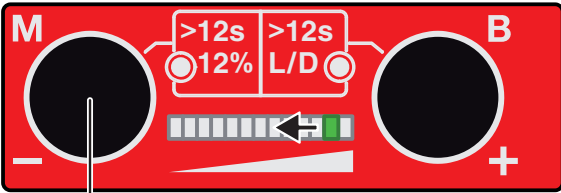
<p>Briefly pressing the '+' button increases the sensitivity of the sensor, the bar graph indicates more signal.</p>  <p style="text-align: center;">Button '+'</p>	<p>Briefly pressing the '-' button decreases the sensitivity of the sensor, the bar graph indicates less signal.</p>  <p style="text-align: center;">Button '-'</p>
--	---

For an optimum setting, the displayed maximum and minimum signal must be symmetric about the switching point (middle of the bar graph).

For devices with tracking function, a fine adjustment of the switching threshold is only possible when tracking is deactivated.

KRT18BM

Multicolor contrast sensor

Enabling/disabling additional functions

Press the button assigned to the additional function for longer than 12 s.

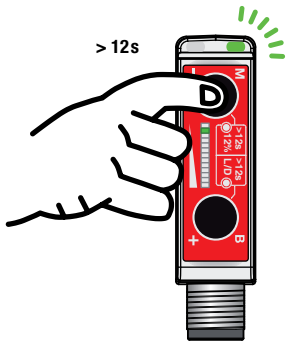

Only the green LED flashes.

Release the button.



LED on = additional function active



LED off = additional function inactive

To change the setting again, push the button again for longer than 12 s and release.

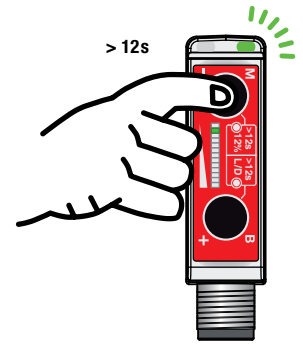

Available special functions (dependent on device model)

12% – switching threshold close to the mark

This function is suitable for applications in which the background exhibits high inhomogeneity. It is operated via the **M** button (> 12 s). The shift of the switching threshold is effective immediately, independent of the teach event.



LED off

Switching threshold in center between mark and background.



LED on

Switching threshold is near the mark.



The LED is also activated if a switching threshold position other than 50% was selected via IO-Link.

L/D – Light/dark switching

The function inverts the switching logic of the switching outputs. It is operated via the **B** button (> 12 s).



LED off

OUT1 (Pin 4): high signal on mark.
OUT2 (Pin 2): low signal on mark.



LED on

OUT1 (Pin 4): low signal on mark.
OUT2 (Pin 2): high signal on mark.

TRA – Tracking function

This function increases the process stability of the contrast sensor. Even if the mark changes slightly in color or contrast, the sensor operates with optimum switching threshold since the threshold is automatically readjusted during the process. It is operated via the **B** button (> 12 s).



LED off

Tracking function inactive.



LED on

Tracking function active.

IO-Link interface

Contrast sensor KRT18B... is equipped with an IO-Link interface. Furthermore, the sensor can easily, quickly and, thereby, economically be configured and diagnostic information read out. With a small amount of effort, the sensor can also be integrated in the control.

The sensor can be economically integrated in the control via an IO-Link master. The device description file (IODD) is required for this purpose. An exact specification of the IO-Link parameters can be found in the corresponding HTML file. All files are available in the download area of the sensor at www.leuze.com.

PC configuration and visualization is performed comfortably with the USB-IO-Link Master SET US2-IL1.1 (part no. 50121098) and the Leuze Sensor Studio (in the download area of the sensor at www.leuze.com).

IO-Link process data

The sensor transmits 2 bytes to the master.

Data bit																Assignment	Default settings
15	14	13	12	11	10	9	8	7	6	5	4	3	2	1	0		
																Switching output	0 = no mark, 1 = mark detected
																Tracking warning ¹⁾	0 = no warning, 1 = warning
																Sensor operation	0 = off, 1 = on
																Switching threshold LSB	Value range 0 ... 31 (0 ... 100% in approx. 3% steps) 0% = min. switching threshold 100% = max. switching threshold
																Switching threshold	
																Switching threshold	
																Switching threshold	
																Switching threshold MSB	
																Active transmitter LSB	00 = red, 01 = green, 10 = blue
																Active transmitter MSB	
																Not used	free
																Measurement value LSB	Value range 0 ... 31 (0 ... 100% in approx. 3% steps) 0% = min. signal level 100% = max. signal level
																Measurement value	
																Measurement value	
																Measurement value	
																Measurement value MSB	

1) Only in combination with tracking function. For sensor versions without tracking function, this bit is not used.

Visualizing the process data with Leuze Sensor Studio

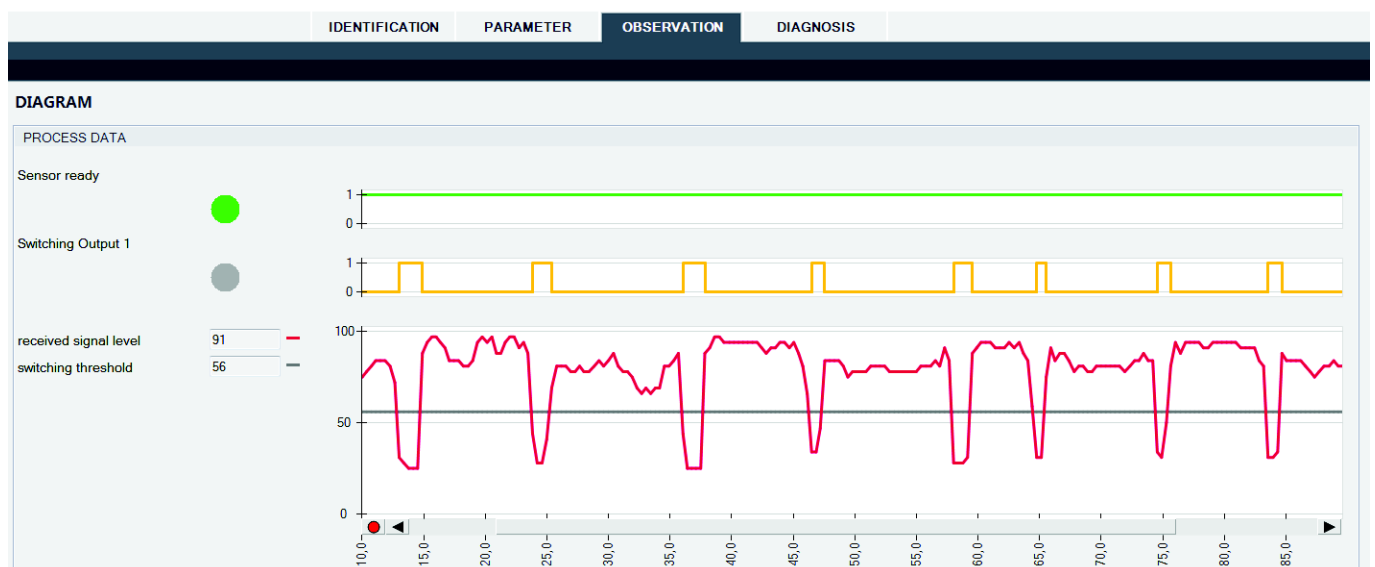

Simple visualization of the process data in the **Leuze Sensor Studio** PC configuration software enables a fast assessment of the process stability.

KRT18BM

Multicolor contrast sensor

Mark counter

Contrast sensor KRT18B... has an internal mark counter. This counts the switching events and can be freely read out and reset. This function enables a simple validation of the process.

Overview of the most important configuration options via IO-Link

Function block	Function	Description
General	Lock operational controls	Operation of both teach buttons is disabled.
	Lock Easytune	Fine adjustment of the sensitivity via the + and - buttons is disabled.
	Device reset	Factory settings are restored.
	Tracking function ¹⁾	The tracking function can be switched on and off here.
Switching output	Switching output function OUT1	The output can be set to "high signal on mark" or "low signal on mark".
	Switching output function OUT2	The output can be set to "inverted function with respect to OUT1" (antivalent output), "identical function as OUT1" (useful in IO-Link dual-channel operation) or to "warning output" ¹⁾ (with tracking devices, this signals if the sensitivity can no longer be readjusted; in this case, devices must then be retaught).
	Time module	Time functions can be configured here. The functions act on all switching outputs. The most important time function is pulse stretching. This is used to extend even very short output signals to a minimum length to allow them to be detected by a slower control input.
Teach	Transmitter color during teach	The colors used during teach can be selected here. It makes sense to restrict colors if teaching with certain colors is found through experience to produce especially good results, particularly in the case of inhomogeneous objects. Normally, all three colors should be used.
	Static 2-point teach	Mark and background are taught one after the other. When teaching on the mark, the mark is positioned in the light spot, the teach is started and then the background is presented and the teach concluded. When teaching on the background, the order is reversed.
	Dynamic 2-point teach	The process is started with the light spot on the background. Multiple marks are moved through the light spot. The teach is then concluded.
	Teach status	The status of the last teach is displayed here. The following values are possible: "teach successful", "teach error" (is displayed if the contrast between mark and background during the teach is too low) and "last valid values used" (is displayed after acknowledgment of a teaching error).
	Reset teaching error	A teaching error can be reset here. The last valid teach values are restored.
Switching threshold position	Selection of the switching threshold position	The position of the switching threshold between mark and background can be selected here. As a rule, a 50% threshold (in center between mark and background) is useful. With very inhomogeneous backgrounds, a threshold near the mark (e.g., 12%) results in increased detection reliability. The position of the switching threshold can be changed independent of a teach event.
	Easytune: increase sensitivity	This is an alternate possibility for making fine adjustments to the switching threshold. The sensitivity of the sensor is increased by one increment; dark colors (e.g., marks) tend to be detected. Corresponds to a short press of the + button on the sensor.
	Easytune: reduce sensitivity	The sensitivity of the sensor is reduced by one increment; light colors (e.g., background) tend not to be detected. Corresponds to a short press of the - button on the sensor.
Teach result memory	Index for loading a teach result memory	Max. 30 teach results stored in the main memory can be loaded here. This is an important property for recipe modifications.
	Index for writing a teach result memory	Max. 30 teach results can be stored in the sensor here. This is an important property for recipe modifications.
	Display teach result memory	The stored teach results can be read out here without needing to load them in the main memory.
Working parameters	The current working parameters of the sensor are stored here. If the teach results are not stored in the sensor, but rather in the control and are to be reloaded during a recipe/format change, then these parameters must be read out or rewritten.	

1) Only for sensor versions with tracking function

Diagnostic data

The process reliability can be read out in the diagnostic data following a teach-in. This information refers only to the two taught values for mark and background. For very inhomogeneous detection objects, the true process reliability may deviate from the displayed value.

- **100%**: very high process reliability
- **75%**: high process reliability
- **50%**: sufficient contrast between background and mark.
Fluttering of the materials that are to be detected should be avoided.
- **25%**: low contrast between background and mark.
Very stable process conditions must be ensured; fluttering of the materials that are to be detected must absolutely be avoided. In some cases, reteaching with the sensor at an incline of 10°...15° relative to normal yields better process conditions.

Sensor adjustments via the IN input (Pin 5)

In addition to configuring via IO-Link, many sensor functions can also be configured via the teach input.

 **Signal level LOW $\leq 2V$**
Signal level HIGH $\geq (U_B - 2V)$

Teach-in

Static 2-point teach

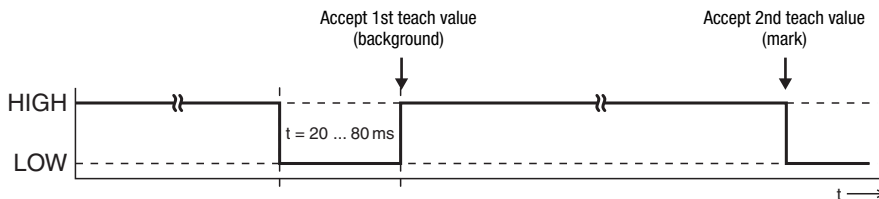

Dynamic 2-point teach

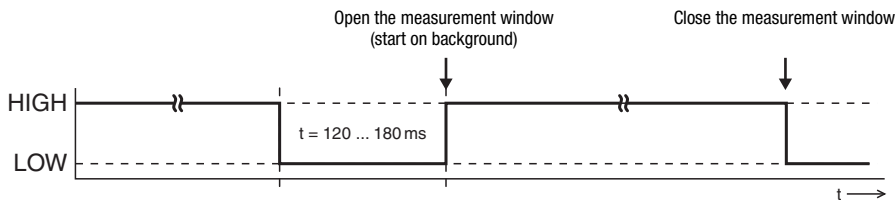

Switching threshold

Switching threshold close to the mark

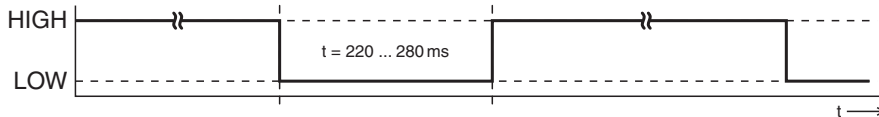

Switching threshold in center between mark and background

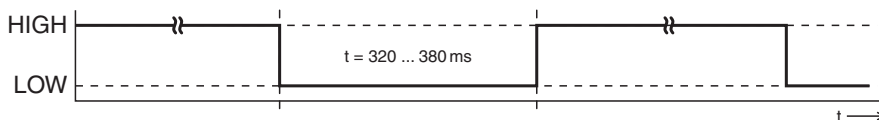

Light/dark switching

Low signal on mark (OUT1)

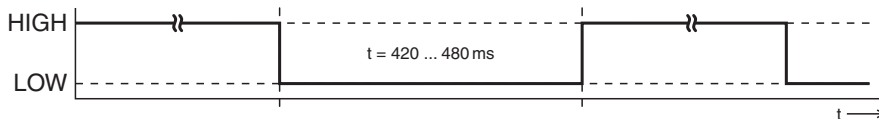

High signal on mark (OUT1)

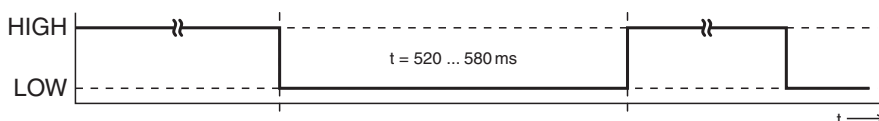

Tracking function

Activating the tracking function

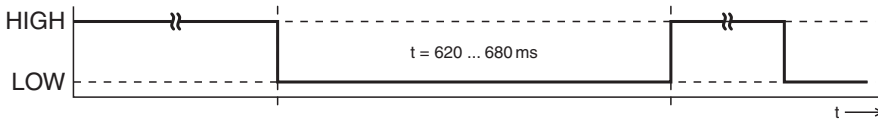

Deactivating the tracking function

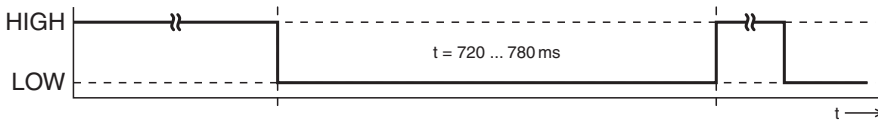

Locking teach buttons via the IN input (Pin 5)

i A **static HIGH signal** ($\geq 20\text{ms}$) at the **IN input** (Pin 5) locks all operational controls on the sensor if required, such that no manual operation is possible (e.g., protection from erroneous operation or manipulation).

If the input is not connected or if a static LOW signal is being applied, all operational controls are unlocked and can be operated freely.

Note:

Locking of the operational controls is also possible via IO-Link.

