

SFH 206 K

Radial Sidelooker

Silicon PIN Photodiode



Applications

- Electronic Equipment
- Industrial Automation (Machine Controls, Light Barriers, Vision Controls)
- White Goods

Features:

- Package: clear epoxy
- Qualifications: The product qualification test plan is based on the guidelines of AEC-Q101-REV-C, Stress Test Qualification for Automotive Grade Discrete Semiconductors.
- ESD: 2 kV acc. to ANSI/ESDA/JEDEC JS-001 (HBM, Class 2)
- Especially suitable for applications from 400 nm to 1100 nm
- Short switching time (typ. 20 ns)
- 5 mm LED plastic package
- Also available on tape and reel

Ordering Information

Type	Photocurrent ¹⁾ $E_v = 1000 \text{ lx; Std. Light A; } V_R = 5 \text{ V}$ I_p	Photocurrent typ. $E_v = 1000 \text{ lx; Std. Light A; } V_R = 5 \text{ V}$ I_p	Ordering Code
SFH 206 K	$\geq 55 \mu\text{A}$	$80 \mu\text{A}$	Q62702P0129

Maximum Ratings

 $T_A = 25\text{ °C}$

Parameter	Symbol		Values
Operating Temperature	T_{op}	min. max.	-40 °C 100 °C
Storage temperature	T_{stg}	min. max.	-40 °C 100 °C
Reverse voltage	V_R	max.	32 V
Total power dissipation	P_{tot}	max.	150 mW
ESD withstand voltage acc. to ANSI/ESDA/JEDEC JS-001 (HBM, Class 2)	V_{ESD}	max.	2 kV

Characteristics

$T_A = 25\text{ °C}$

Parameter	Symbol		Values
Spectral sensitivity $V_R = 5\text{ V}$; Std. Light A; $T = 2856\text{ K}$	S	min. typ.	50 nA/lx 80 nA/lx
Wavelength of max sensitivity	$\lambda_{S\text{ max}}$	typ.	920 nm
Spectral range of sensitivity	$\lambda_{10\%}$	typ.	420 ... 1120 nm
Radiant sensitive area	A	typ.	7.02 mm ²
Dimensions of active chip area	L x W	typ.	2.65 x 2.65 mm x mm
Half angle	φ	typ.	60 °
Dark current $V_R = 10\text{ V}$	I_R	typ. max.	2 nA 30 nA
Spectral sensitivity of the chip $\lambda = 850\text{ nm}$	S_λ	typ.	0.62 A / W
Quantum yield of the chip $\lambda = 850\text{ nm}$	η	typ.	0.90 Electrons / Photon
Open-circuit voltage $E_v = 1000\text{ lx}$; Std. Light A; $V_R = 0\text{ V}$	V_O	min. typ.	310 mV 365 mV
Short-circuit current $E_v = 1000\text{ lx}$; Std. Light A; $V_R = 0\text{ V}$	I_{sc}	typ.	80 μ A
Rise time $V_R = 5\text{ V}$; $R_L = 50\ \Omega$; $\lambda = 850\text{ nm}$; $I_p = 800\ \mu$ A	t_r	typ.	0.02 μ s
Fall time $V_R = 5\text{ V}$; $R_L = 50\ \Omega$; $\lambda = 850\text{ nm}$; $I_p = 800\ \mu$ A	t_f	typ.	0.02 μ s
Forward voltage $I_F = 100\text{ mA}$; $E = 0$	V_F	typ.	1.3 V
Capacitance $V_R = 0\text{ V}$; $f = 1\text{ MHz}$; $E = 0$	C_0	typ.	72 pF
Temperature coefficient of voltage	TC_V	typ.	-2.6 mV / K
Temperature coefficient of short-circuit current Std. Light A	TC_I	typ.	0.18 % / K
Noise equivalent power $V_R = 10\text{ V}$; $\lambda = 850\text{ nm}$	NEP	typ.	0.041 pW / Hz ^{1/2}
Detection limit $V_R = 10\text{ V}$; $\lambda = 850\text{ nm}$	D^*	typ.	6.5e12 cm x Hz ^{1/2} / W

Relative Spectral Sensitivity ^{2), 3)}

$$S_{rel} = f(\lambda)$$

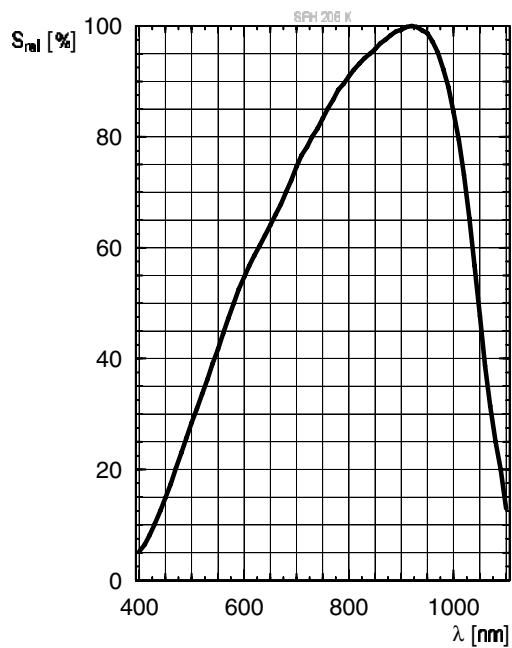

Directional Characteristics ^{2), 3)}

$$S_{rel} = f(\varphi)$$

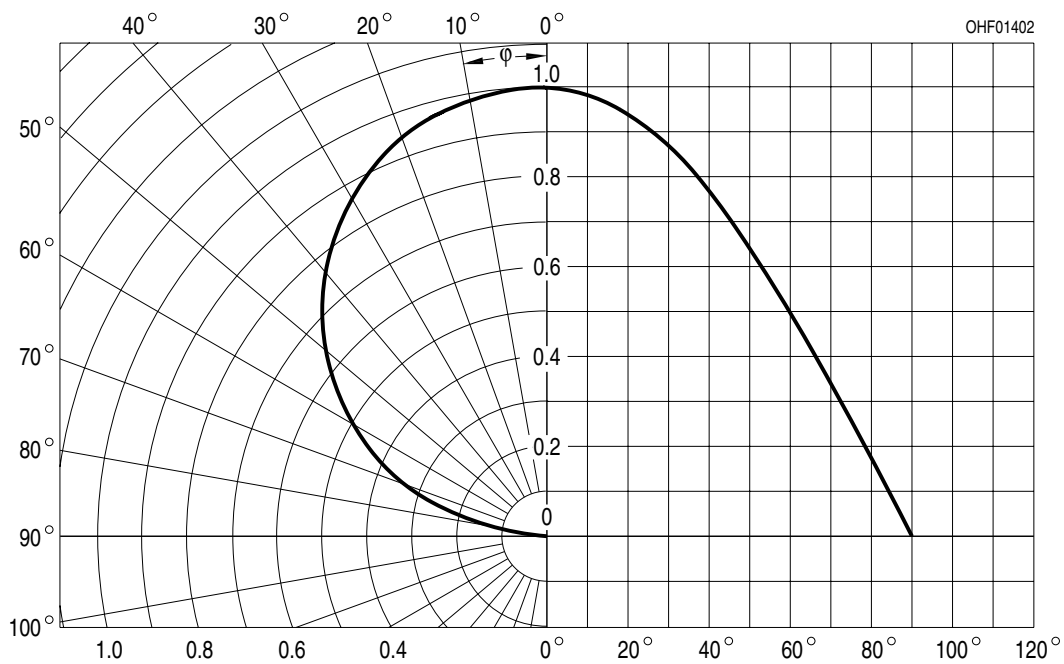

Photocurrent/Open-Circuit Voltage 2), 3)

$I_P (V_R = 5 \text{ V}) / V_O = f(E_V)$

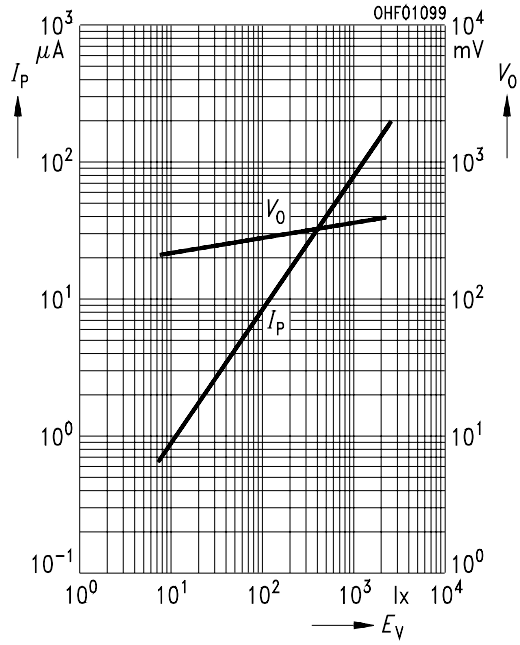

Dark Current 2), 3)

$I_R = f(V_R); E = 0$

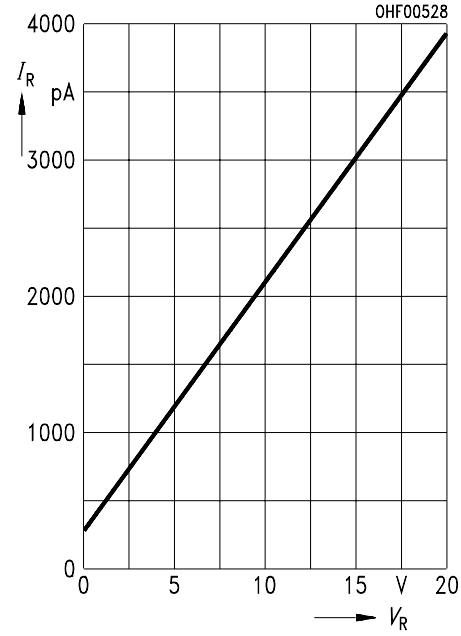

Capacitance 2), 3)

$C = f(V_R); f = 1\text{MHz}; E = 0; T_A = 25^\circ\text{C}$

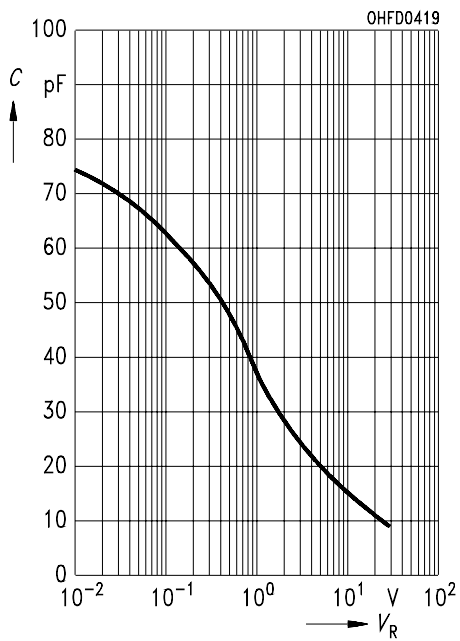

Dark Current ²⁾

$$I_R = f(T_A); E = 0; V_R = 10 \text{ V}$$

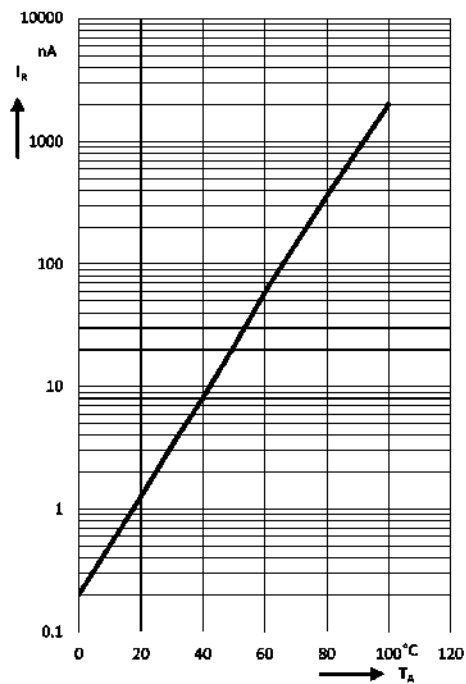

Power Consumption

$$P_{\text{tot}} = f(T_A)$$

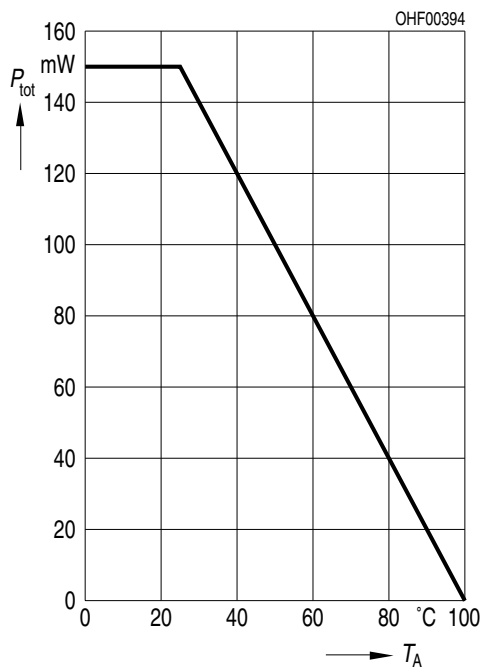

Dimensional Drawing ⁴⁾

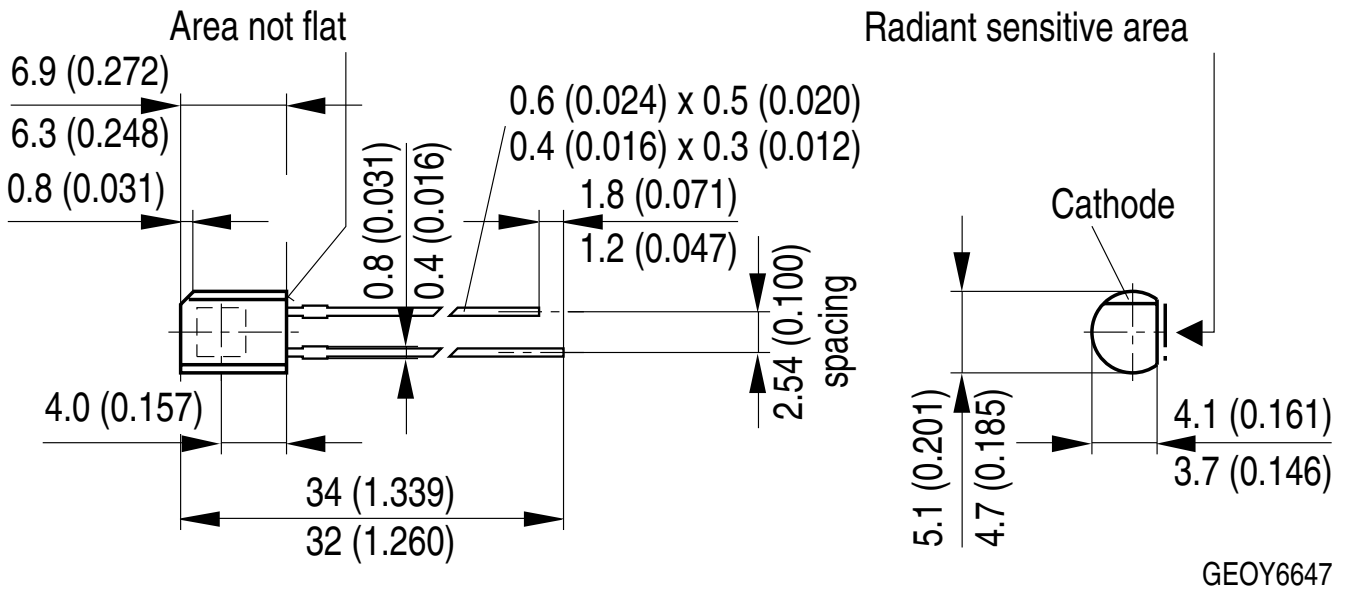

GEOY6647

Further Information:

- Approximate Weight:** 276.0 mg
- Package marking:** Cathode

Recommended Solder Pad ⁴⁾

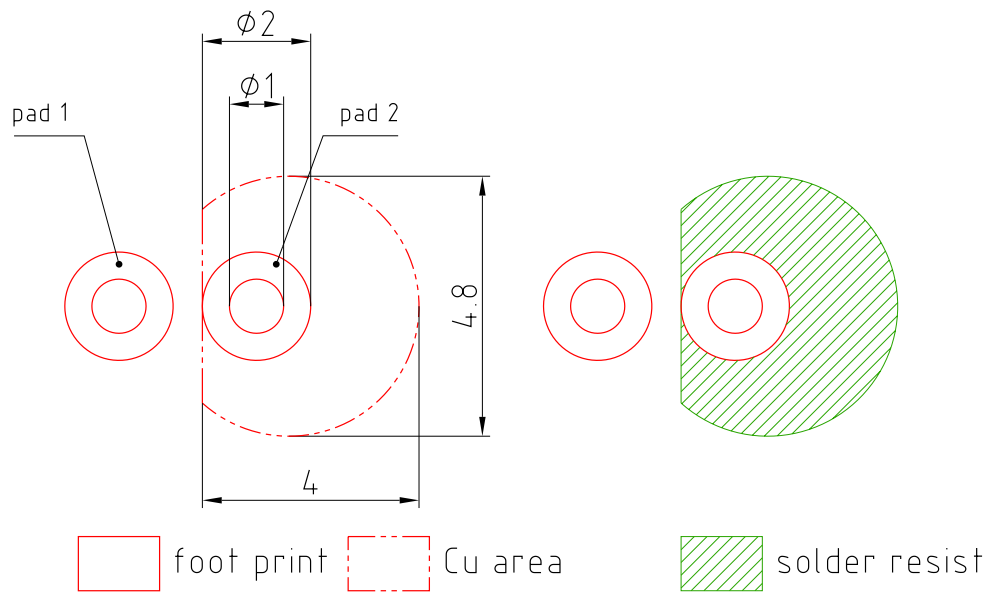

E062.3010.188-01

Pad 1: anode

TTW Soldering

IEC-61760-1 TTW

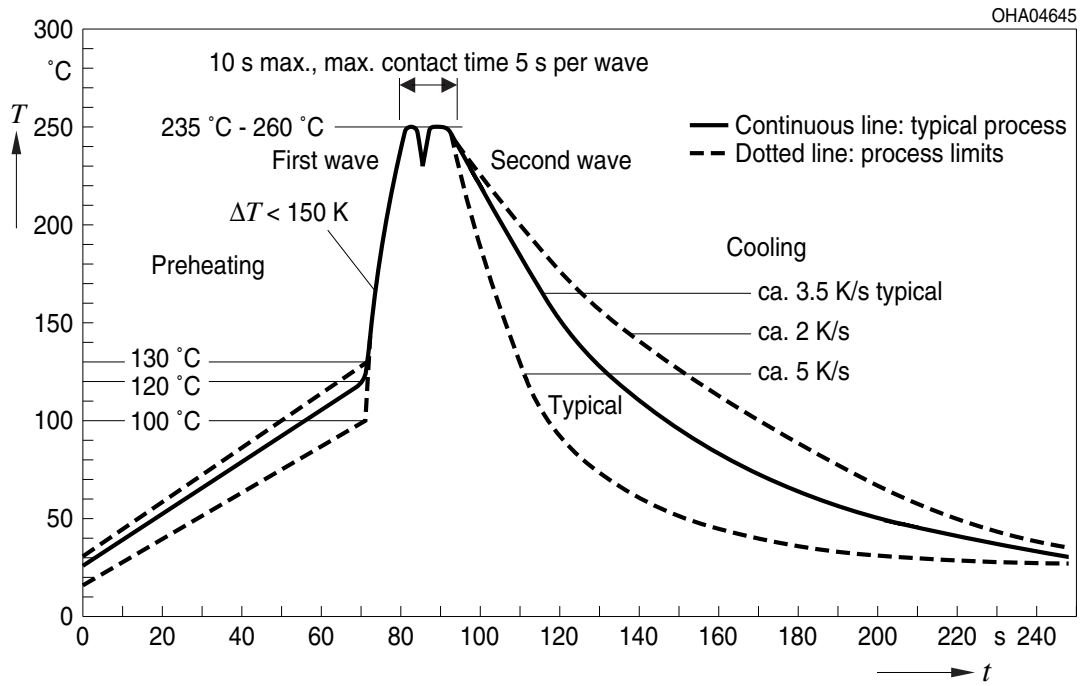

Notes

The evaluation of eye safety occurs according to the standard IEC 62471:2006 (photo biological safety of lamps and lamp systems). Within the risk grouping system of this IEC standard, the device specified in this data sheet falls into the class **exempt group (exposure time 10000 s)**. Under real circumstances (for exposure time, conditions of the eye pupils, observation distance), it is assumed that no endangerment to the eye exists from these devices. As a matter of principle, however, it should be mentioned that intense light sources have a high secondary exposure potential due to their blinding effect. When looking at bright light sources (e.g. headlights), temporary reduction in visual acuity and afterimages can occur, leading to irritation, annoyance, visual impairment, and even accidents, depending on the situation.

Subcomponents of this device contain, in addition to other substances, metal filled materials including silver. Metal filled materials can be affected by environments that contain traces of aggressive substances. Therefore, we recommend that customers minimize device exposure to aggressive substances during storage, production, and use. Devices that showed visible discoloration when tested using the described tests above did show no performance deviations within failure limits during the stated test duration. Respective failure limits are described in the IEC60810.

For further application related information please visit www.osram-os.com/appnotes

Disclaimer

Attention please!

The information describes the type of component and shall not be considered as assured characteristics. Terms of delivery and rights to change design reserved. Due to technical requirements components may contain dangerous substances.

For information on the types in question please contact our Sales Organization.

If printed or downloaded, please find the latest version on the OSRAM OS website.

Packing

Please use the recycling operators known to you. We can also help you – get in touch with your nearest sales office. By agreement we will take packing material back, if it is sorted. You must bear the costs of transport. For packing material that is returned to us unsorted or which we are not obliged to accept, we shall have to invoice you for any costs incurred.

Product and functional safety devices/applications or medical devices/applications

OSRAM OS components are not developed, constructed or tested for the application as safety relevant component or for the application in medical devices.

OSRAM OS products are not qualified at module and system level for such application.

In case buyer – or customer supplied by buyer – considers using OSRAM OS components in product safety devices/applications or medical devices/applications, buyer and/or customer has to inform the local sales partner of OSRAM OS immediately and OSRAM OS and buyer and /or customer will analyze and coordinate the customer-specific request between OSRAM OS and buyer and/or customer.

Glossary

- 1) **Photocurrent:** The photocurrent values are measured (by irradiating the devices with a homogenous light source and applying a voltage to the device) with a tolerance of $\pm 11\%$.
- 2) **Typical Values:** Due to the special conditions of the manufacturing processes of semiconductor devices, the typical data or calculated correlations of technical parameters can only reflect statistical figures. These do not necessarily correspond to the actual parameters of each single product, which could differ from the typical data and calculated correlations or the typical characteristic line. If requested, e.g. because of technical improvements, these typ. data will be changed without any further notice.
- 3) **Testing temperature:** $T_A = 25^\circ\text{C}$ (unless otherwise specified)
- 4) **Tolerance of Measure:** Unless otherwise noted in drawing, tolerances are specified with ± 0.1 and dimensions are specified in mm.

Revision History

Version	Date	Change
1.4	2020-01-07	Electro - Optical Characteristics (Diagrams)

Published by OSRAM Opto Semiconductors GmbH EU RoHS and China RoHS compliant product
Leibnizstraße 4, D-93055 Regensburg
www.osram-os.com © All Rights Reserved.



此产品符合欧盟 RoHS 指令的要求；
按照中国的相关法规和标准，不含有毒有害物质或元素。