



EVERLIGHT ELECTRONICS CO.,LTD.

Device Number : CDLE-038-131 REV.: 2

5.0mm Round Type LED Lamps

PART NO. : 383-2UBGC ECN : _____ Page: 1/4

■ Features :

- Choice of various viewing angles
- Available on tape and reel.
- Reliable and robust

■ Descriptions :

The series is specially designed for

- applications requiring higher brightness
- The led lamps are available with different colors, intensities, epoxy colors, etc.

■ Applications :

- TV set
- Monitor
- Telephone
- Computer

■ Package Dimensions:

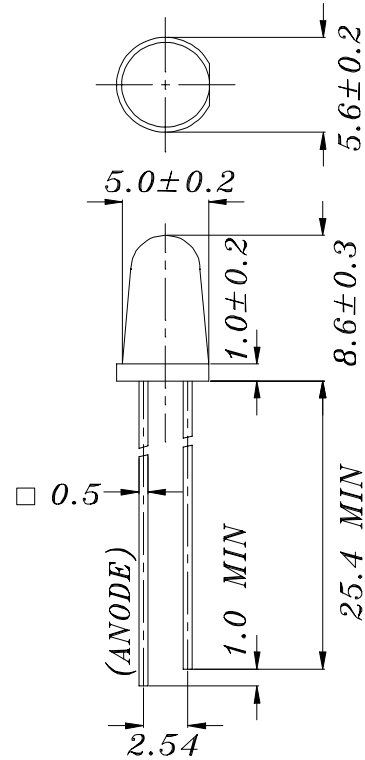

■ Notes :

1. All dimensions are in millimeters.
2. An epoxy meniscus may extend about 1.5mm(0.059") down to the lead.
3. Tolerances unless Dimension $\pm 0.25\text{mm}$.

PART NO.	Chip		Lens Color
	Material	Emitted Color	
383-2UBGC	InGaN/SiC	Super Blue Green	Water Clear

OFFICE : NO. 25,Lane 76,Sec.3, Chung Yang Rd., Tucheng 236, Taipei, Taiwan, R.O.C.

TEL : 886-2-2267-2000,2267-9936

FAX : 886-2-2267-6244,22676189,22676306

<http://www.everlight.com>

a0106041,#010610



EVERLIGHT ELECTRONICS CO.,LTD.

Device Number : CDLE-(CDLE-038-131) REV.: 2

5.0mm Round Type LED Lamps

PART NO. : 333-2UBGC ECN : _____ Page: 4/4

■ Reliability test items and conditions:

NO	Item	Test Conditions	Test Hours/Cycle	Sample Size	Ac/Re
1	Solder Heat	TEMP : 260°C ± 5 °C	5 SEC	76 PCS	0/1
2	Temperature Cycle	H : +85°C 30min ∫ 5 min L : -55°C 30min	50 CYCLES	76 PCS	0/1
3	Thermal Shock	H : +100°C 5min ∫ 10 sec L : -10°C 5min	50 CYCLES	76 PCS	0/1
4	High Temperature Storage	TEMP : 100°C	1000 HRS	76 PCS	0/1
5	Low Temperature Storage	TEMP : -55°C	1000 HRS	76 PCS	0/1
6	DC Operating Life	TEMP : 25°C IF = 20 mA	1000 HRS	76 PCS	0/1
7	High Temperature / High Humidity	85°C / 85% RH	1000 HRS	76 PCS	0/1



EVERLIGHT ELECTRONICS CO.,LTD.

Device Number : CDLE-038-131 REV.: 2

5.0mm Round Type LED Lamps

PART NO. : 383-2UBG 333-2UBGC ECN : _____ Page: 3/4

■ Typical Electro-Optical Characteristic Curves:

(UBG)

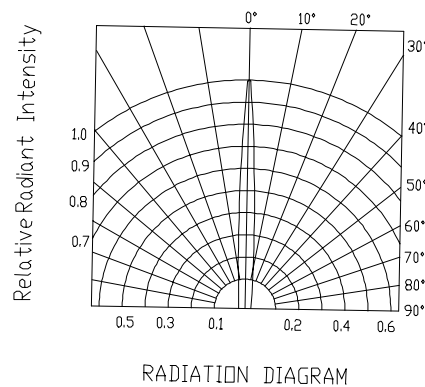
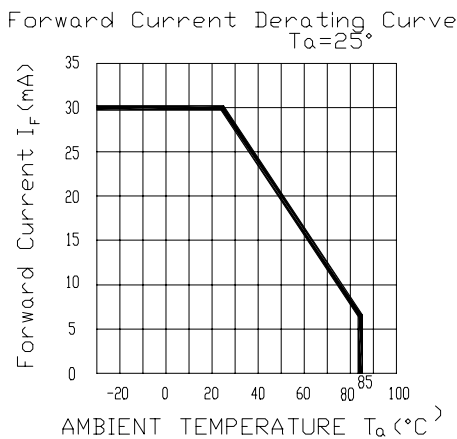
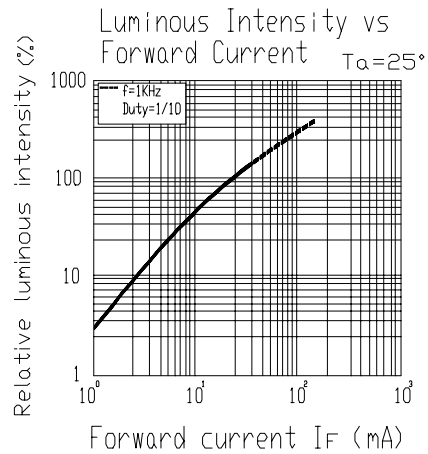
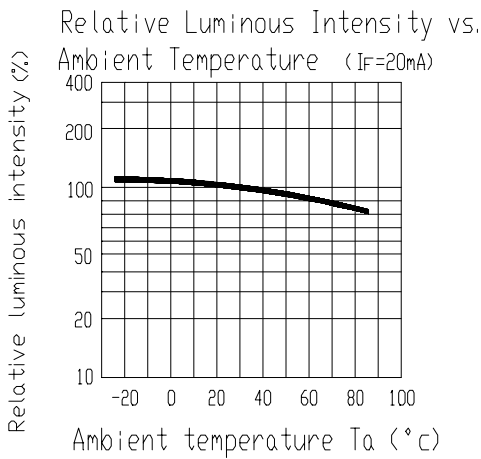
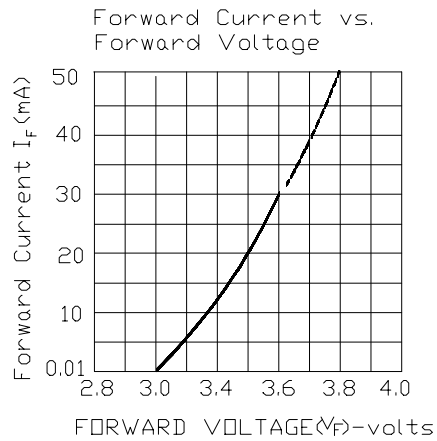
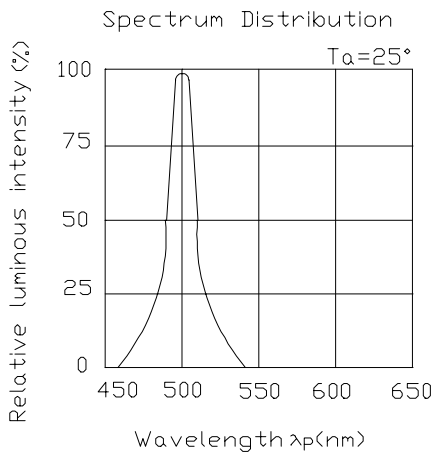



EVERLIGHT ELECTRONICS CO.,LTD.

Device Number : CDLE-038-131 REV.: 2

5.0mm Round Type LED Lamps

PART NO. : 333-2UBGC

ECN : Page: 2/4

■ Absolute Maximum Ratings at Ta = 25°C

Parameter	Symbol	Rating	Unit
Forward Current	IF	30	mA
Operating Temperature	Topr	-40 to +85	°C
Storage Temperature	Tstg	-40 to +100	°C
Soldering Temperature	Tsol	260 ± 5	°C
Electrostatic Discharge	ESD	1000	V
Power Dissipation	Pd	120	mW
Peak Forward Current(Duty 1/10 @ 1KHz)	IF(Peak)	100	mA
Reverse Voltage	VR	5	V

■ Electronic Optical Characteristics :

Parameter	Symbol	Min	Typ.	Max.	Unit	Condition
Luminous Intensity	Iv	1500.00	2500.00	/	mcd	IF= 20 mA
Viewing Angle	2θ 1/2	/	6	/	deg	IF= 20 mA
Peak Wavelength	λ p	/	502	/	nm	IF= 20 mA
Dominant Wavelength	λ d	/	505	/	nm	IF= 20 mA
Spectrum Radiation Bandwidth	△ λ	/	30	/	nm	IF= 20 mA
Forward Voltage	VF	/	3.50	4.00	V	IF= 20 mA
Reverse Current	IR	/	/	10	μ A	VR= 5 V