

STANDARD EXECUTIONS

Base with a slotted pass-through hole and AISI 304 stainless steel threaded blind joint or AISI 303 stainless steel threaded stem with AISI 304 stainless steel nut:

- **LMD.F-SL-SST (d2)**: threaded blind ball joint, without no-slip disk.
- **LMD.F-SL-SST-TV (d2)**: threaded blind ball joint, with vulcanised rubber (NBR) with no-slip coating hardness 70 Shore A tolerance +/-5.
- **LMD.F-SL-SST (d2 - I)**: threaded stem, without no-slip disk.
- **LMD.F-SL-SST-TV (d2 - I)**: threaded stem, with vulcanised rubber (NBR) with no-slip coating hardness 70 Shore A tolerance +/-5.

Base with two slotted pass-through holes and AISI 304 stainless steel threaded blind joint or AISI 303 stainless steel threaded stem with AISI 304 stainless steel nut:

- **LMD.F-2SL-SST (d2)**: threaded blind ball joint, without no-slip disk.
- **LMD.F-2SL-SST-TV (d2)**: threaded blind ball joint, with vulcanised rubber (NBR) with no-slip coating hardness 70 Shore A tolerance +/-5.
- **LMD.F-2SL-SST (d2 - I)**: threaded stem, without no-slip disk.
- **LMD.F-2SL-SST-TV (d2 - I)**: threaded stem, with vulcanised rubber (NBR) with no-slip coating hardness 70 Shore A tolerance +/-5.

SET SCREW

Stainless steel.

FEATURES

The bases of the LMD.F-SST levelling feet are provided with one or two slotted pass-through holes to allow fixing to the mounting surface and correct adjustment, preventing lateral movement.

The versions with non-slip coating are particularly suitable for use on sensitive surfaces.

The levelling feet are supplied fully assembled, not removable.



LMD.F-SL-SST

LMD.F-SL-SST-TV

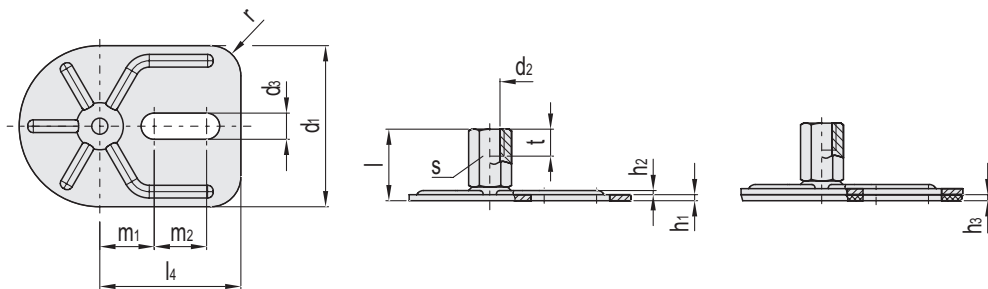

LMD.F-SL-SST (d2)

LMD.F-SL-SST-TV (d2)



Code	Description	Code	Description	d1	l	l4	d2	d3	h1	h2	h3#	m1	m2	s	r	t	Δ
409171	LMD.F-SL-80-SST-M8	409172	LMD.F-SL-80-SST-M8-TV	80	26	70	M8	13	3	1.3	3	27	26	14	15	8	221
409181	LMD.F-SL-80-SST-M10	409182	LMD.F-SL-80-SST-M10-TV	80	29	70	M10	13	3	1.3	3	27	26	14	15	10	221
409193	LMD.F-SL-80-SST-M12	409194	LMD.F-SL-80-SST-M12-TV	80	32	70	M12	13	3	1.3	3	27	26	17	15	12	232
409205	LMD.F-SL-80-SST-M16	409206	LMD.F-SL-80-SST-M16-TV	80	38	70	M16	13	3	1.3	3	27	26	22	15	16	248
409219	LMD.F-SL-80-SST-M20	409220	LMD.F-SL-80-SST-M20-TV	80	45	70	M20	13	3	1.3	3	27	26	27	15	20	314

Levelling feet and supports

2 # only for TV executions

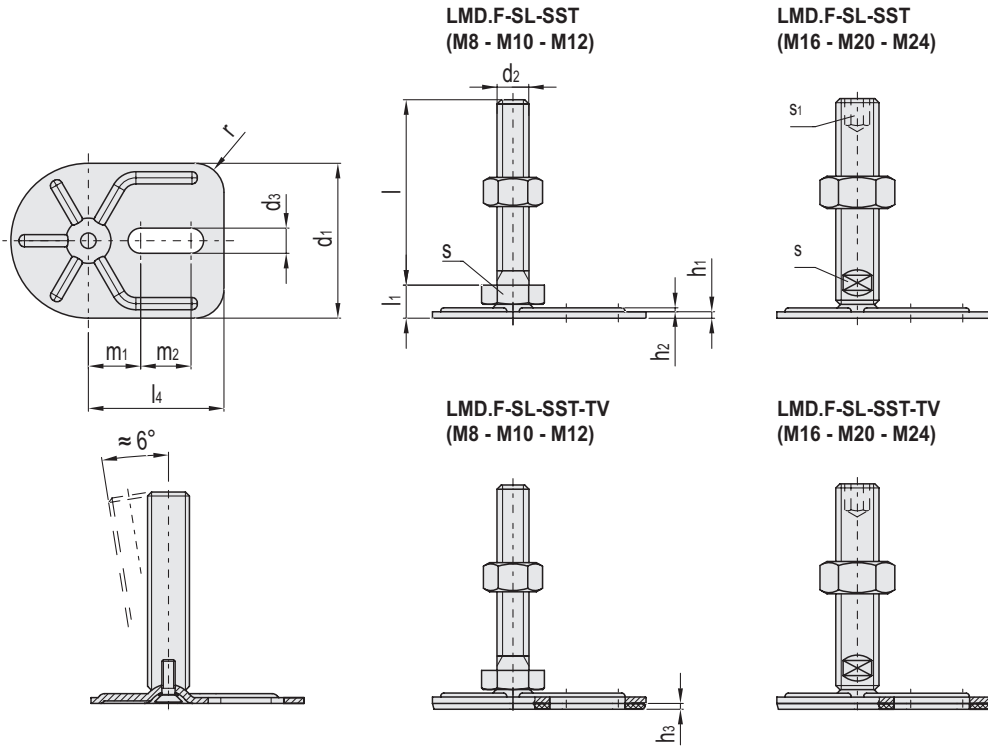

LMD.F-SL-SST (d2 - l)

LMD.F-SL-SST-TV (d2 - l)



Code	Description	Code	Description	d1	l	l1	l4	d2	d3	h1	h2	h3#	m1	m2	s	s1	r	Δ
409173	LMD.F-SL-80-SST-M8x40	409174	LMD.F-SL-80-SST-M8x40-TV	80	40	12	70	M8	13	3	1.3	3	27	26	17	-	15	203
409175	LMD.F-SL-80-SST-M8x50	409176	LMD.F-SL-80-SST-M8x50-TV	80	50	12	70	M8	13	3	1.3	3	27	26	17	-	15	206
409177	LMD.F-SL-80-SST-M8x63	409178	LMD.F-SL-80-SST-M8x63-TV	80	63	12	70	M8	13	3	1.3	3	27	26	17	-	15	210
409183	LMD.F-SL-80-SST-M10x50	409184	LMD.F-SL-80-SST-M10x50-TV	80	50	12	70	M10	13	3	1.3	3	27	26	17	-	15	241
409185	LMD.F-SL-80-SST-M10x60	409186	LMD.F-SL-80-SST-M10x60-TV	80	60	12	70	M10	13	3	1.3	3	27	26	17	-	15	245
409187	LMD.F-SL-80-SST-M10x80	409188	LMD.F-SL-80-SST-M10x80-TV	80	80	12	70	M10	13	3	1.3	3	27	26	17	-	15	255
409189	LMD.F-SL-80-SST-M10x100	409190	LMD.F-SL-80-SST-M10x100-TV	80	100	12	70	M10	13	3	1.3	3	27	26	17	-	15	266
409195	LMD.F-SL-80-SST-M12x60	409196	LMD.F-SL-80-SST-M12x60-TV	80	60	12	70	M12	13	3	1.3	3	27	26	17	-	15	258
409197	LMD.F-SL-80-SST-M12x80	409198	LMD.F-SL-80-SST-M12x80-TV	80	80	12	70	M12	13	3	1.3	3	27	26	17	-	15	272
409199	LMD.F-SL-80-SST-M12x100	409200	LMD.F-SL-80-SST-M12x100-TV	80	100	12	70	M12	13	3	1.3	3	27	26	17	-	15	287
409201	LMD.F-SL-80-SST-M12x125	409202	LMD.F-SL-80-SST-M12x125-TV	80	125	12	70	M12	13	3	1.3	3	27	26	17	-	15	304
409207	LMD.F-SL-80-SST-M16x75	409208	LMD.F-SL-80-SST-M16x75-TV	80	75	18	70	M16	13	3	1.3	3	27	26	12	8	15	313
409209	LMD.F-SL-80-SST-M16x100	409210	LMD.F-SL-80-SST-M16x100-TV	80	100	18	70	M16	13	3	1.3	3	27	26	12	8	15	345
409211	LMD.F-SL-80-SST-M16x125	409212	LMD.F-SL-80-SST-M16x125-TV	80	125	18	70	M16	13	3	1.3	3	27	26	12	8	15	378
409213	LMD.F-SL-80-SST-M16x150	409214	LMD.F-SL-80-SST-M16x150-TV	80	150	18	70	M16	13	3	1.3	3	27	26	12	8	15	410
409215	LMD.F-SL-80-SST-M16x200	409216	LMD.F-SL-80-SST-M16x200-TV	80	200	18	70	M16	13	3	1.3	3	27	26	12	8	15	476
409221	LMD.F-SL-80-SST-M20x75	409222	LMD.F-SL-80-SST-M20x75-TV	80	75	19	70	M20	13	3	1.3	3	27	26	15	10	15	395
409223	LMD.F-SL-80-SST-M20x100	409224	LMD.F-SL-80-SST-M20x100-TV	80	100	19	70	M20	13	3	1.3	3	27	26	15	10	15	633
409225	LMD.F-SL-80-SST-M20x125	409226	LMD.F-SL-80-SST-M20x125-TV	80	125	19	70	M20	13	3	1.3	3	27	26	15	10	15	496
409227	LMD.F-SL-80-SST-M20x150	409228	LMD.F-SL-80-SST-M20x150-TV	80	150	19	70	M20	13	3	1.3	3	27	26	15	10	15	554
409229	LMD.F-SL-80-SST-M20x200	409230	LMD.F-SL-80-SST-M20x200-TV	80	200	19	70	M20	13	3	1.3	3	27	26	15	10	15	649
409233	LMD.F-SL-80-SST-M24x100	409234	LMD.F-SL-80-SST-M24x100-TV	80	100	22	70	M24	13	3	1.3	3	27	26	19	12	15	672
409235	LMD.F-SL-80-SST-M24x125	409236	LMD.F-SL-80-SST-M24x125-TV	80	125	22	70	M24	13	3	1.3	3	27	26	19	12	15	664
409237	LMD.F-SL-80-SST-M24x150	409238	LMD.F-SL-80-SST-M24x150-TV	80	150	22	70	M24	13	3	1.3	3	27	26	19	12	15	745
409239	LMD.F-SL-80-SST-M24x200	409240	LMD.F-SL-80-SST-M24x200-TV	80	200	22	70	M24	13	3	1.3	3	27	26	19	12	15	881

only for TV executions

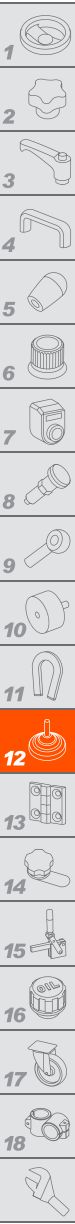

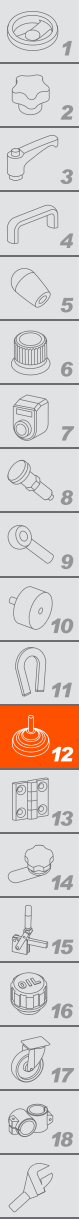

LMD.F-2SL-SST

LMD.F-2SL-SST-TV

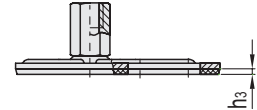
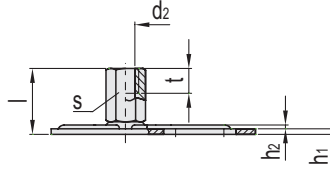
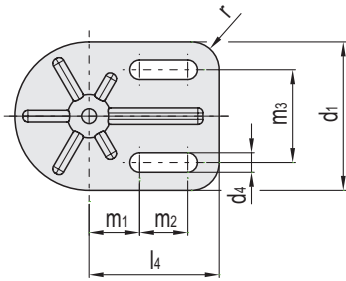

LMD.F-2SL-SST (d2)

LMD.F-2SL-SST-TV (d2)

Code	Description	Code	Description	d1	l	l4	d2	d4	h1	h2	h3#	m1	m2	m3	s	r	t	△
409315	LMD.F-2SL-80-SST-M8	409316	LMD.F-2SL-80-SST-M8-TV	80	26	70	M8	10.5	3	1.3	3	27	26	50	14	15	8	214
409325	LMD.F-2SL-80-SST-M10	409326	LMD.F-2SL-80-SST-M10-TV	80	29	70	M10	10.5	3	1.3	3	27	26	50	14	15	10	214
409337	LMD.F-2SL-80-SST-M12	409338	LMD.F-2SL-80-SST-M12-TV	80	32	70	M12	10.5	3	1.3	3	27	26	50	17	15	12	227
409349	LMD.F-2SL-80-SST-M16	409350	LMD.F-2SL-80-SST-M16-TV	80	38	70	M16	10.5	3	1.3	3	27	26	50	22	15	16	243
409363	LMD.F-2SL-80-SST-M20	409364	LMD.F-2SL-80-SST-M20-TV	80	45	70	M20	10.5	3	1.3	3	27	26	50	27	15	20	308

LMD.F-2SL-SST (M8 - M10 - M12)

LMD.F-2SL-SST (M16 - M20 - M24)

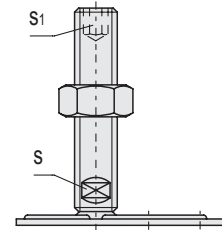
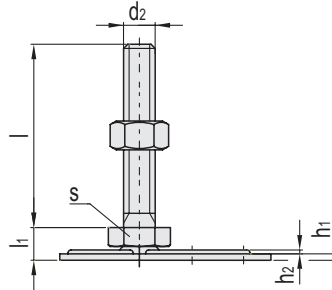
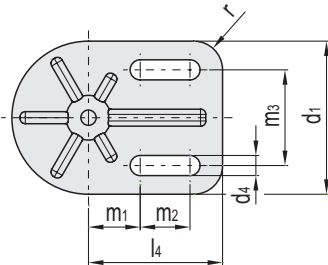

LMD.F-2SL-SST-TV (M8 - M10 - M12)

LMD.F-2SL-SST-TV (M16 - M20 - M24)

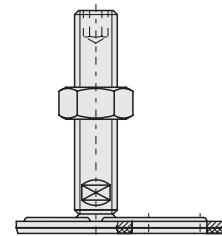
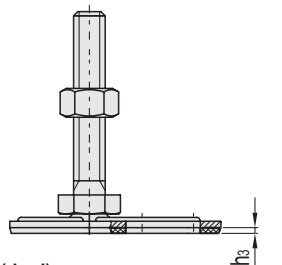
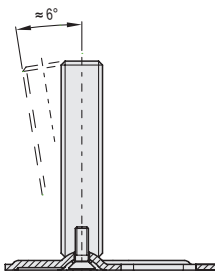

LMD.F-2SL-SST (d2 - l)

LMD.F-2SL-SST-TV (d2 - l)

Code	Description	Code	Description	d1	l	l1	l4	d2	d4	h1	h2	h3#	m1	m2	m3	s	s1	r	△
409317	LMD.F-2SL-80-SST-M8x40	409318	LMD.F-2SL-80-SST-M8x40-TV	80	40	12	70	M8	10.5	3	1.3	3	27	26	50	17	-	15	193
409319	LMD.F-2SL-80-SST-M8x50	409320	LMD.F-2SL-80-SST-M8x50-TV	80	50	12	70	M8	10.5	3	1.3	3	27	26	50	17	-	15	196
409321	LMD.F-2SL-80-SST-M8x63	409322	LMD.F-2SL-80-SST-M8x63-TV	80	63	12	70	M8	10.5	3	1.3	3	27	26	50	17	-	15	200
409327	LMD.F-2SL-80-SST-M10x50	409328	LMD.F-2SL-80-SST-M10x50-TV	80	50	12	70	M10	10.5	3	1.3	3	27	26	50	17	-	15	234
409329	LMD.F-2SL-80-SST-M10x60	409330	LMD.F-2SL-80-SST-M10x60-TV	80	60	12	70	M10	10.5	3	1.3	3	27	26	50	17	-	15	238
409331	LMD.F-2SL-80-SST-M10x80	409332	LMD.F-2SL-80-SST-M10x80-TV	80	80	12	70	M10	10.5	3	1.3	3	27	26	50	17	-	15	248
409333	LMD.F-2SL-80-SST-M10x100	409334	LMD.F-2SL-80-SST-M10x100-TV	80	100	12	70	M10	10.5	3	1.3	3	27	26	50	17	-	15	259
409339	LMD.F-2SL-80-SST-M12x60	409340	LMD.F-2SL-80-SST-M12x60-TV	80	60	12	70	M12	10.5	3	1.3	3	27	26	50	17	-	15	253
409341	LMD.F-2SL-80-SST-M12x80	409342	LMD.F-2SL-80-SST-M12x80-TV	80	80	12	70	M12	10.5	3	1.3	3	27	26	50	17	-	15	267
409343	LMD.F-2SL-80-SST-M12x100	409344	LMD.F-2SL-80-SST-M12x100-TV	80	100	12	70	M12	10.5	3	1.3	3	27	26	50	17	-	15	282
409345	LMD.F-2SL-80-SST-M12x125	409346	LMD.F-2SL-80-SST-M12x125-TV	80	125	12	70	M12	10.5	3	1.3	3	27	26	50	17	-	15	299

Levelling feet and supports

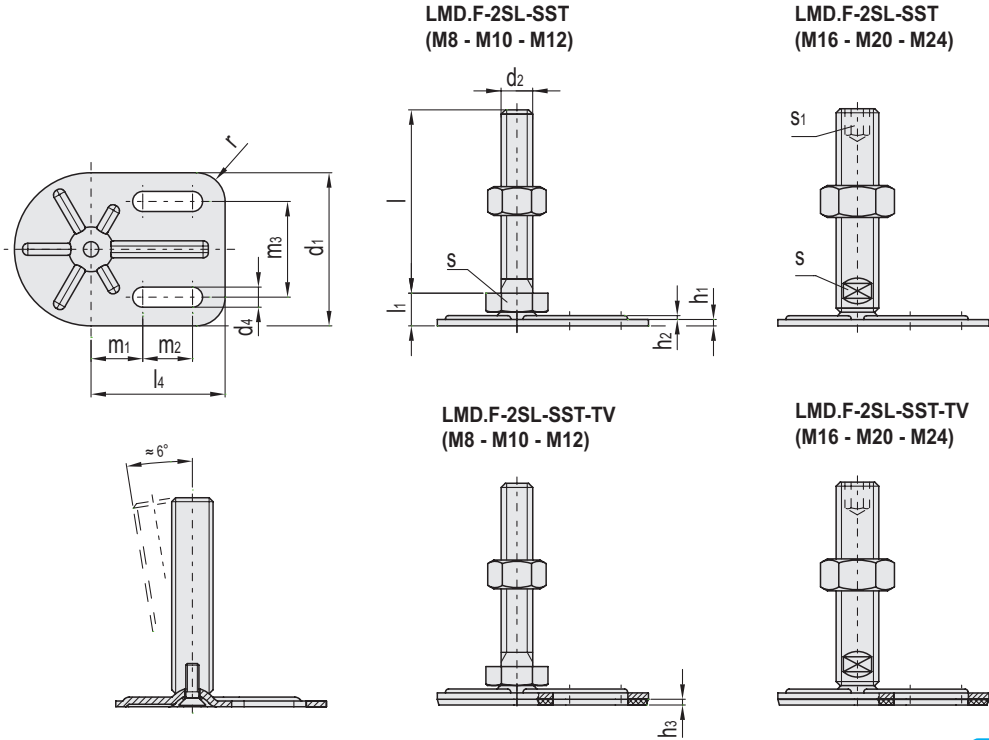

LMD.F-2SL-SST (d2 - l)

LMD.F-2SL-SST-TV (d2 - l)



Code	Description	Code	Description	d1	l	l1	l4	d2	d4	h1	h2	h3#	m1	m2	m3	s	s1	r	⚖
409351	LMD.F-2SL-80-SST-M16x75	409352	LMD.F-2SL-80-SST-M16x75-TV	80	75	18	70	M16	10.5	3	1.3	3	27	26	50	12	8	15	308
409353	LMD.F-2SL-80-SST-M16x100	409354	LMD.F-2SL-80-SST-M16x100-TV	80	100	18	70	M16	10.5	3	1.3	3	27	26	50	12	8	15	340
409355	LMD.F-2SL-80-SST-M16x125	409356	LMD.F-2SL-80-SST-M16x125-TV	80	125	18	70	M16	10.5	3	1.3	3	27	26	50	12	8	15	373
409357	LMD.F-2SL-80-SST-M16x150	409358	LMD.F-2SL-80-SST-M16x150-TV	80	150	18	70	M16	10.5	3	1.3	3	27	26	50	12	8	15	405
409359	LMD.F-2SL-80-SST-M16x200	409360	LMD.F-2SL-80-SST-M16x200-TV	80	200	18	70	M16	10.5	3	1.3	3	27	26	50	12	8	15	471
409365	LMD.F-2SL-80-SST-M20x75	409366	LMD.F-2SL-80-SST-M20x75-TV	80	75	19	70	M20	10.5	3	1.3	3	27	26	50	15	10	15	389
409367	LMD.F-2SL-80-SST-M20x100	409368	LMD.F-2SL-80-SST-M20x100-TV	80	100	19	70	M20	10.5	3	1.3	3	27	26	50	15	10	15	627
409369	LMD.F-2SL-80-SST-M20x125	409370	LMD.F-2SL-80-SST-M20x125-TV	80	125	19	70	M20	10.5	3	1.3	3	27	26	50	15	10	15	490
409371	LMD.F-2SL-80-SST-M20x150	409372	LMD.F-2SL-80-SST-M20x150-TV	80	150	19	70	M20	10.5	3	1.3	3	27	26	50	15	10	15	548
409373	LMD.F-2SL-80-SST-M20x200	409374	LMD.F-2SL-80-SST-M20x200-TV	80	200	19	70	M20	10.5	3	1.3	3	27	26	50	15	10	15	643
409377	LMD.F-2SL-80-SST-M24x100	409378	LMD.F-2SL-80-SST-M24x100-TV	80	100	22	70	M24	10.5	3	1.3	3	27	26	50	19	12	15	666
409379	LMD.F-2SL-80-SST-M24x125	409380	LMD.F-2SL-80-SST-M24x125-TV	80	125	22	70	M24	10.5	3	1.3	3	27	26	50	19	12	15	658
409381	LMD.F-2SL-80-SST-M24x150	409382	LMD.F-2SL-80-SST-M24x150-TV	80	150	22	70	M24	10.5	3	1.3	3	27	26	50	19	12	15	739
409383	LMD.F-2SL-80-SST-M24x200	409384	LMD.F-2SL-80-SST-M24x200-TV	80	200	22	70	M24	10.5	3	1.3	3	27	26	50	19	12	15	875

only for TV executions