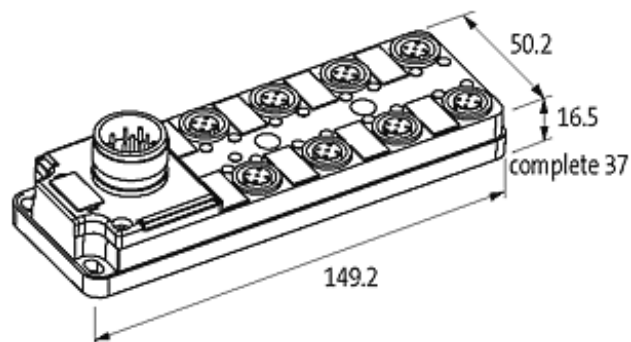

MVP12, 8XM12, 5POLE, M23 19POL. CON.

Connector exit frontside

8-way, 5-pole
M23 plug connection
19-pole used
with LED for digital PNP-signals 24 V DC

Plastic housings with good resistance against chemicals and oils. The resistance to aggressive media should be individually tested for your application. Further details on request.

[Link to Product](#)**Illustration**

stay connected

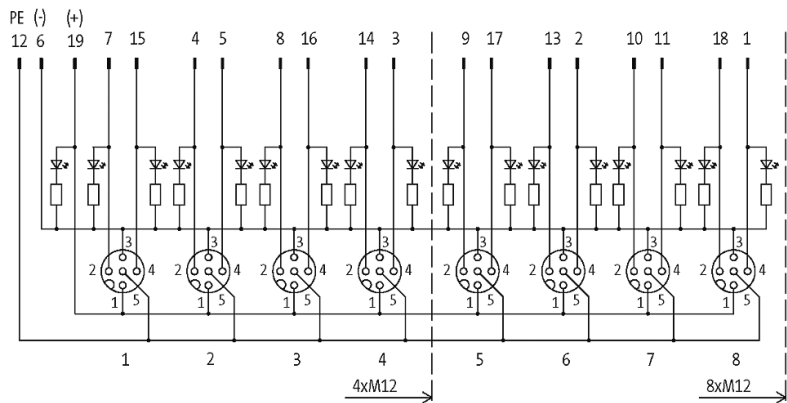
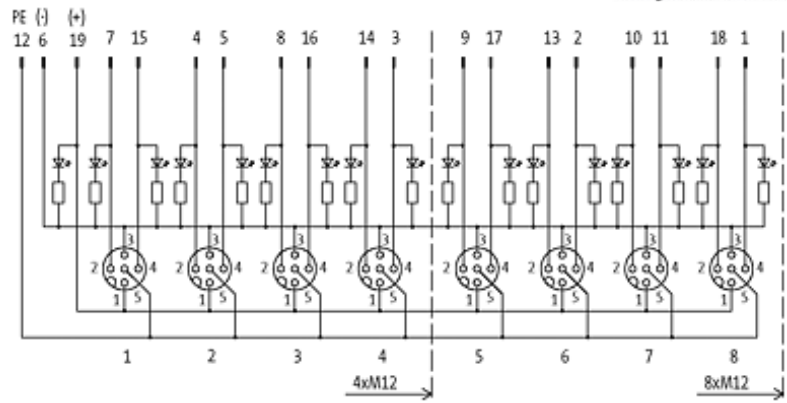

M12-Females 5-pole

M23-Plug 19-pole

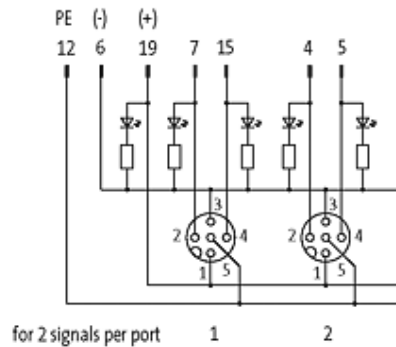
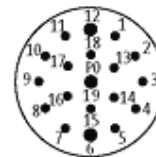
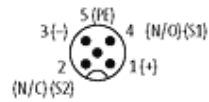

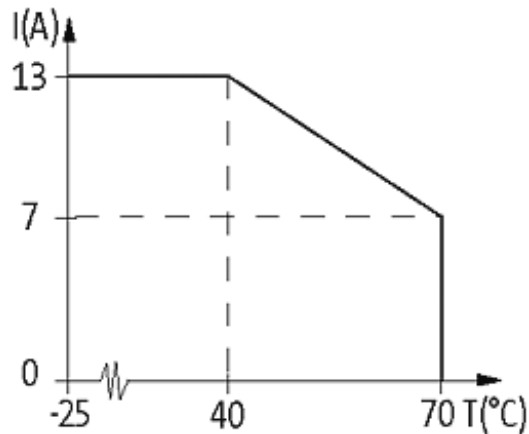

Product may differ from Image

Approvals



Technical Data

Operating voltage	24 V DC
Signal per port	2
Operating current per contact	max. 4 A
Total current	max. 10 A
Housing	Plastic, flame retardant
Protection	IP67 inserted and tightened (EN 60529)
Locking of ports	Screw thread M12 × 1 mm

General data

Temperature range	-20...+80 °C
Dimensions H × W × D	149.2×50.2×16.5 mm

Contact layout

Contact 1	(+)
Contact 2	(NC)/(S2)
Contact 3	(-)
Contact 4	(NO)/(S1)
Contact 5	(Earth)
LED display	LED (green): Power / LED (yellow): (S1/S2)

Commercial data

country of origin	DE
customs tariff number	85369010
minimum order quantity	1