

Actuator/sensor cable, PVC
Connection cable
PKW4Z-2/TEL

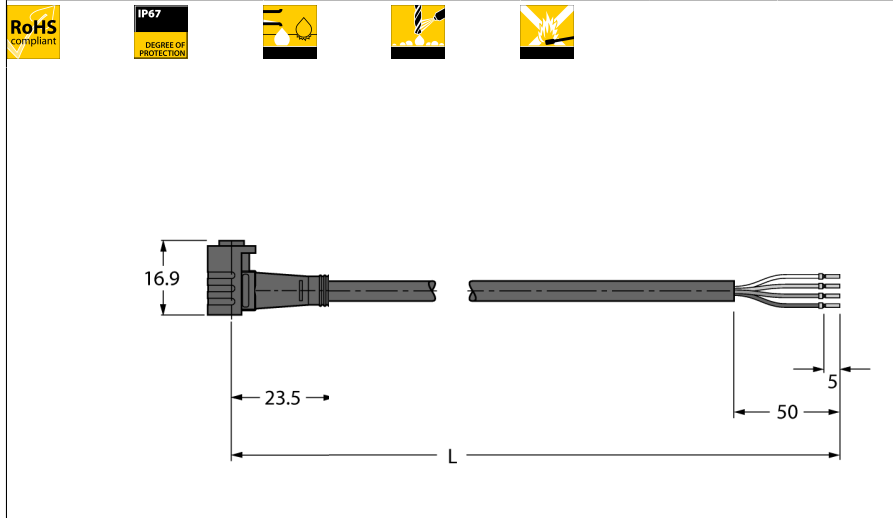

- Female Ø 8 mm, angled, 4-pin, snap-on, with pull-off protection
- Sheath material: PVC
- Sheath color: black
- Resistant to chemicals and oils
- Flame retardant
- Resistant to acids and alkaline solutions
- Resistant to microbes and hydrolysis
- LABS free
- RoHS conform
- Protection class IP67
- Cable length: 2.0 m

Cable Cross-section

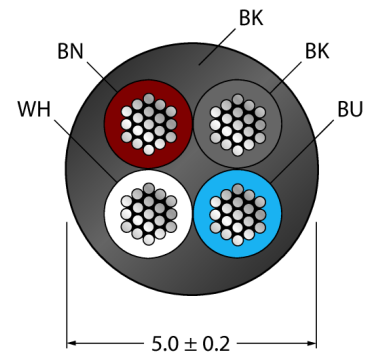

Type designation	PKW4Z-2/TEL
Ident no.	6627510
Connector A side	Female connector, Ø 8 mm, Angled
Number of pins	4
Contacts	Brass, CuZn, Gold-plated
Contact carriers	Plastic, TPU, Black
Grip	Plastic, TPU, Black
Seal	Plastic, FPM/FKM
Protection class	IP67, (plugged)
Mechanical lifespan	> 100 Mating cycles
Pollution degree	3
Tightening torque	0.5 ... 0.6 Nm (observe max. torque of counter piece!)
General data	
Cable diameter	5 ± 0.20mm
Cable length	2 m
Cable quality	PVC
Cable color	Black
Core insulation	PVC
Core colors	BN, WH, BU, BK
Core cross-section	4x0.34mm ²
Arrangement of strands	42x0.1 mm
Electrical features at +20 °C	
Current	4 A
Rated voltage	30 V
Insulation resistance	> 30.5 MΩ/km
Test voltage	2000 V
Forward resistance	max. 57 Ω/km
Mechanical and chemical properties	
Bending radius (stationary laying)	> 5 x Ø
Bending radius (flexible use)	> 10 x Ø
Ambient temperature	
Stationary	-40...+105°C
In motion	0...+80°C

Circuit Diagram

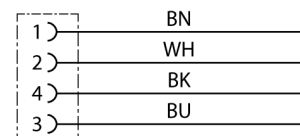

Actuator/sensor cable, PVC
Connection cable
PKW4Z-2/TEL

Accessories

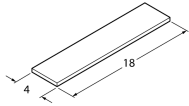
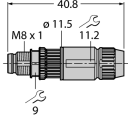
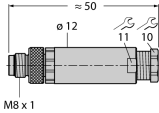
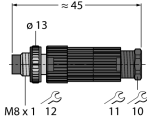
Type code	Ident no.	Description	
Torque-Wrench-Set-AS	6936170	Torque wrench set; handles with adjustable torque 0.4-1.0 Nm, torque wrench for M8 (SW9), fork wrench for M12 (SW 14)	
BLANK-LABEL-FOR-CORDSETS-TEL-TXL	6936206	Label for TEL and TXL cables, length: 18 mm, height: 4 mm, material: polycarbonate (PC), color: white, halogen-free and flame-retardant	
HAS5141-0	6905403	Field-wireable male connector, M8 (M8 x 1), straight, 4-pin, insulation piercing connection, cable feedthrough 2.5 to 5.1 mm, core cross-section/terminal capacity 0.14 to 0.34 mm ² , plastic housing, metal nut	
BS5143-0	6901013	Field-wireable male connector, M8 (M8 x 1), straight, 4-pin, screw terminal connection, cable feedthrough 3.5 to 5.0 mm, core cross-section/terminal capacity 0.14 to 0.50 mm ² , plastic housing, metal nut	
HS5141-0	6902730	Field-wireable male connector, M8 (M8 x 1), straight, 4-pin, pressfit technology, cable feedthrough 4.0 to 5.0 mm, core cross-section/terminal capacity 0.14 to 0.34 mm ² , plastic housing, metal nut	

Actuator/sensor cable, PVC
 Connection cable
 PKW4Z-2/TEL

Accessories

Type code	Ident no.	Description	
HS5241-0	6902830	Field-wireable male connector, M8 (↙) 1, angled, 4-pin, pressfit technology, cable feedthrough 4.0 to 5.0 mm, core cross-section/terminal capacity 0.14 to 0.34 mm ² , plastic housing, metal nut	