

Feet · DIN 6320 with threaded shank
22640.0062



Product Description

Feet can be used both as a foot and as a seating element and stop.
Bearing surface without distortion.

Material

- Heat-treated steel, unhardened, blackened

Drawing

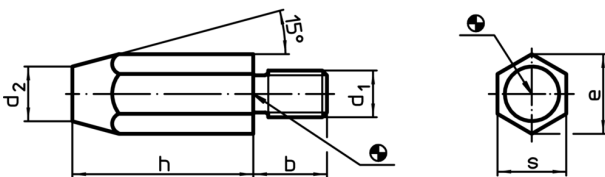

Order information

h	d ₁	Dimensions		e	s	Tightening torque max. [Nm]	[g]	Art. No.
		b	d ₂ [mm]					
20	M6	11	6	11.5	10	7	13	22640.0062

Application example

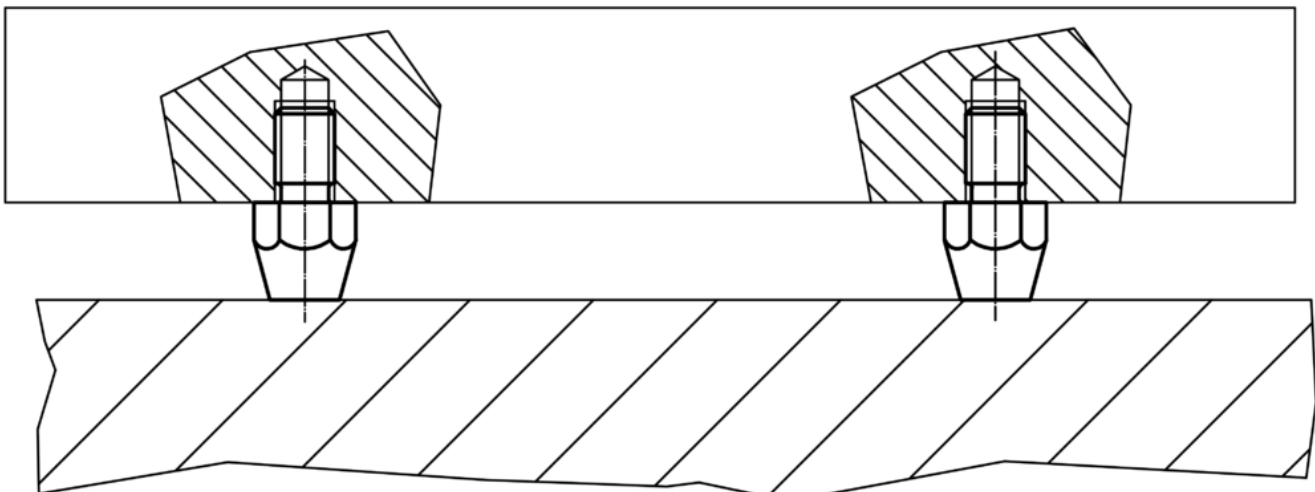

Compliance

RoHS compliant

Contains lead - compliant according to exceptions 6a / 6b / 6c

Contains SVHC substances >0,1% w/w

Contains lead - SVHC list [REACH] as of 10.06.2022

Contains Proposition 65 substances



Lead can cause cancer and reproductive harm from exposure
<https://www.P65Warnings.ca.gov/>

Free from Conflict Minerals

This product does not contain any substances designated as "conflict minerals" such as tantalum, tin, gold or tungsten from the Democratic Republic of Congo or adjacent countries.