

## LM4140 High Precision Low Noise Low Dropout Voltage Reference

Check for Samples: [LM4140](#)

### FEATURES

- **High Initial Accuracy: 0.1%**
- **Ultra Low Noise**
- **Low Temperature Coefficient: 3 ppm/°C (A grade)**
- **Low Voltage Operation: 1.8V**
- **Low Dropout Voltage: 20 mV (typ) @ 1mA**
- **Supply Current: 230  $\mu$ A (typ),  $\leq$  1  $\mu$ A Disable Mode**
- **Enable Pin**
- **Output Voltage Options: 1.024V, 1.250V, 2.048V, 2.500V, and 4.096V**
- **Custom Voltages from 0.5V to 4.5V**
- **Temperature Range (0°C to 70°C)**

### APPLICATIONS SUMMARY

- **Portable, Battery Powered Equipment**
- **Instrumentation and Test Equipment**
- **Automotive**
- **Industrial Process Control**
- **Data Acquisition Systems**
- **Medical Equipment**
- **Precision Scales**
- **Servo Systems**
- **Battery Charging**

### DESCRIPTION

The LM4140 series of precision references are designed to combine high accuracy, low drift and noise with low power dissipation in a small package.

The LM4140 is the industry's first reference with output voltage options lower than the bandgap voltage.

The key to the advance performance of the LM4140 is the use of EEPROM registers and CMOS DACs for temperature coefficient curvature correction and trimming of the output voltage accuracy of the device during the final production testing.

The major advantage of this method is the much higher resolution available with DACs than is available economically with most methods utilized by other bandgap references.

The low input and dropout voltage, low supply current and output drive capability of the LM4140 makes this product an ideal choice for battery powered and portable applications.

The LM4140 is available in three grades (A, B, C) with 0.1% initial accuracy and 3, 6 and 10 ppm/°C temperature coefficients. For even lower Tempco, contact Texas Instruments.

The device performance is specified over the temperature range (0°C to +70°C) and is available in compact 8-pin package.

**For other output voltage options from 0.5V to 4.5V, contact Texas Instruments.**



Please be aware that an important notice concerning availability, standard warranty, and use in critical applications of Texas Instruments semiconductor products and disclaimers thereto appears at the end of this data sheet.

All trademarks are the property of their respective owners.

**Typical Application**

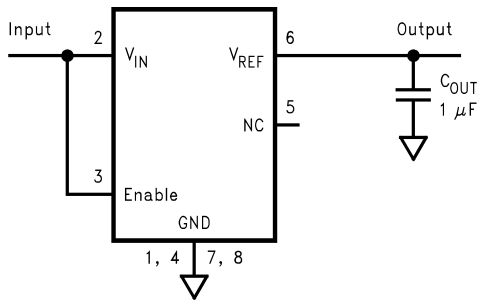

C<sub>OUT</sub>, Output bypass capacitor. See text for selection detail.

**Figure 1.**

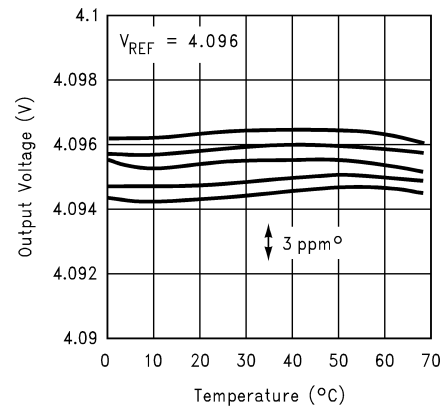

**Figure 2. Typical Temperature Coefficient (Sample of 5 Parts)**

**Connection Diagram**

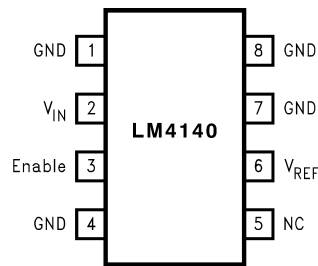

**Figure 3. 8-Lead Surface Mount Package Number D0008A Top View**

**PIN DESCRIPTIONS**

<b>V<sub>ref</sub> (Pin 6):</b>	Reference Output. Capable of sourcing up to 8mA.
<b>Input (Pin 2):</b>	Positive Supply.
<b>Ground (Pins 1, 4, 7, 8):</b>	Negative Supply or Ground Connection. These pins must be connected to ground.
<b>Enable (Pin 3):</b>	Pulled to input for normal operation. Forcing this pin to ground will turn-off the output.
<b>NC (Pin 5):</b>	This pin must be left open.



These devices have limited built-in ESD protection. The leads should be shorted together or the device placed in conductive foam during storage or handling to prevent electrostatic damage to the MOS gates.

### Absolute Maximum Ratings <sup>(1)(2)</sup>

Maximum Voltage on any Input pin	-0.3V to 5.6V
Output Short-Circuit Duration	Indefinite
Power Dissipation ( $T_A = 25^\circ\text{C}$ ) <sup>(3)</sup>	345mW
ESD Susceptibility <sup>(4)</sup>	
Human Body Model	2 kV
Machine Model	200V
Lead Temperature: Soldering, (10 sec.)	+260°C

- (1) Absolute Maximum Ratings indicate limits beyond which damage to the device may occur. Operating Ratings indicate conditions for which the device is intended to be functional, but do not ensure specific performance limits. For ensured specifications and test conditions, see Electrical Characteristics. The ensured specifications apply only for the test conditions listed. Some performance characteristics may degrade when the device is not operated under the listed test conditions.
- (2) If Military/Aerospace specified devices are required, please contact the Texas Instruments Sales Office/ Distributors for availability and specifications.
- (3) Without PCB copper enhancements. The maximum power dissipation must be de-rated at elevated temperatures and is limited by  $T_{JMAX}$  (maximum junction temperature),  $\theta_{J-A}$  (junction to ambient thermal resistance) and  $T_A$  (ambient temperature). The maximum power dissipation at any temperature is:  $P_{DISSMAX} = (T_{JMAX} - T_A)/\theta_{J-A}$  up to the value listed in the Absolute Maximum Ratings. The  $\theta_{J-A}$  for the SO-8 package is  $160^\circ\text{C/W}$ .
- (4) The human body model is a 100 pF capacitor discharged through a 1.5 k $\Omega$  resistor into each pin. The machine model is a 200 pF capacitor discharged directly into each pin.

### Operating Range <sup>(1)</sup>

Storage Temperature Range	-65°C to +150°C
Ambient Temperature Range	0°C to 70°C
Junction Temperature Range	0°C to 80°C

- (1) Absolute Maximum Ratings indicate limits beyond which damage to the device may occur. Operating Ratings indicate conditions for which the device is intended to be functional, but do not ensure specific performance limits. For ensured specifications and test conditions, see Electrical Characteristics. The ensured specifications apply only for the test conditions listed. Some performance characteristics may degrade when the device is not operated under the listed test conditions.

## LM4140 Electrical Characteristics

Unless otherwise specified,  $V_{IN} = 3.0\text{V}$  for the LM4140-1.024 and LM4140-1.250,  $V_{IN} = 5.0\text{V}$  for all other voltage options,  $V_{EN} = V_{IN}$ ,  $C_{OUT} = 1\mu\text{F}$  <sup>(1)</sup>,  $I_{LOAD} = 1\text{mA}$ ,  $T_A = T_J = 25^\circ\text{C}$ . Limits with standard typeface are for  $T_A = 25^\circ\text{C}$ , and limits in **boldface type** apply over  $0^\circ\text{C}$  to  $70^\circ\text{C}$  temperature range.

Symbol	Parameter	Conditions	Min <sup>(2)</sup>	Typ <sup>(3)</sup>	Max <sup>(2)</sup>	Units
$V_{REF}$	Output Voltage Initial Accuracy <sup>(4)</sup>					%
	LM4140B-1.024 LM4140B-1.250 LM4140B-2.048 LM4140B-2.500 LM4140B-4.096				$\pm 0.1$	
	LM4140C-1.024 LM4140C-1.250 LM4140C-2.048 LM4140C-2.500 LM4140C-4.096				$\pm 0.1$	

- (1) For proper operation, a 1 $\mu\text{F}$  capacitor is required between the output pin and the GND pin of the device. (See [Application Hints](#) for details)
- (2) Limits are 100% production tested at 25°C. Limits over the operating temperature range are ensured through correlation using Statistical Quality Control (SQC) methods. The limits are used to calculate TI's Average Outgoing Quality Level (AOQL).
- (3) Typical numbers are at 25°C and represent the most likely parametric norm.
- (4) High temperature and mechanical stress associated with PCB assembly can have significant impact on the initial accuracy of the LM4140 and may create significant shifts in  $V_{REF}$ . See [Application Hints](#) section regarding accuracy and PCB layout consideration.

## LM4140 Electrical Characteristics (continued)

Unless otherwise specified,  $V_{IN} = 3.0V$  for the LM4140-1.024 and LM4140-1.250,  $V_{IN} = 5.0V$  for all other voltage options,  $V_{EN} = V_{IN}$ ,  $C_{OUT} = 1\mu F$ <sup>(1)</sup>,  $I_{LOAD} = 1mA$ ,  $T_A = T_J = 25^\circ C$ . Limits with standard typeface are for  $T_A = 25^\circ C$ , and limits in **boldface type** apply over  $0^\circ C$  to  $70^\circ C$  temperature range.

Symbol	Parameter	Conditions	Min (2)	Typ (3)	Max (2)	Units
$TCV_{REF}/^\circ C$	Temperature Coefficient: A Grade B Grade C Grade	$0^\circ C \leq T_A \leq +70^\circ C$			<b>3</b> <b>6</b> <b>10</b>	ppm/ $^\circ C$
$\Delta V_{REF}/\Delta V_{IN}$	Line Regulation					ppm/V
	1.024V and 1.250V options	$1.8V \leq V_{IN} \leq 5.5V$		50	300	
	All other voltage options	$V_{ref} + 200mV \leq V_{IN} \leq 5.5V$		20	<b>200</b> <b>250</b>	
$\Delta V_{REF}/\Delta I_{LOAD}$	Load Regulation	$1mA \leq I_{LOAD} \leq 8mA$				ppm/mA
	All other voltage options			1	20	
					<b>150</b>	
	4.096V Option			5	35	
					<b>150</b>	
$\Delta V_{REF}$	Long-Term Stability	1000 Hrs		60		ppm
$\Delta V_{REF}$	Thermal Hysteresis <sup>(5)</sup>	$0^\circ C \leq T_A \leq +70^\circ C$		20		ppm
Operating Voltage	LM4140-1.024, LM4140-1.250	$I_L = 1mA$ to $8mA$	<b>1.8</b>		<b>5.5</b>	V
$V_{IN}-V_{REF}$	Dropout Voltage <sup>(6)</sup> LM4140-2.048, LM4140-2.500	$I_L = 1mA$		20	40 <b>45</b>	mV
		$I_L = 8mA$		160	235 <b>400</b>	
	LM4140-4.096	$I_L = 1mA$		20	40 <b>45</b>	
		$I_L = 8mA$		195	270 <b>490</b>	
$V_N$	Output Noise Voltage <sup>(7)</sup>	0.1 Hz to 10 Hz		2.2		$\mu V_{PP}$
$I_{S(ON)}$	Supply Current	$I_{LOAD} = 0mA$				$\mu A$
	All other voltage options			230	320	
					<b>375</b>	
	4.096V Option			265	350	
					<b>400</b>	
$I_{S(OFF)}$	Supply Current	$V_{Enable} < 0.4V$		.01	<b>1</b>	$\mu A$
$V_H$	Logic High Input Voltage		<b><math>0.8V_{IN}</math></b>			V
$I_H$	Logic High Input Current			2		nA
$V_L$	Logic Low Input Voltage				<b>0.4</b>	V
$I_L$	Logic Low Input Current			1		nA
$I_{SC}$	Short Circuit Current		<b>8.5</b>	20	35	mA
					<b>40</b>	

(5) Thermal hysteresis is defined as the changes in  $+25^\circ C$  output voltage before and after the cycling of the device from  $0^\circ C$  to  $70^\circ C$ .

(6) Dropout voltage is defined as the minimum input to output differential voltage at which the output voltage drops by 0.5% below the value measured with  $V_{IN} = 3.0V$  for the LM4140-1.024 and LM4140-1.250,  $V_{IN} = 5.0V$  for all other voltage options.

(7) The output noise is based on 1.024V option. Output noise is linearly proportional to  $V_{REF}$ .

### LM4140 Typical Performance Characteristics

Unless otherwise specified,  $T_A = 25^\circ\text{C}$ , No Load,  $C_{OUT} = 1\mu\text{F}$ ,  $V_{IN} = 3.0\text{V}$  for LM4140-1.024 and LM4140-1.250, and 5V for all other voltage options.  $V_{IN} = V_{EN}$ .

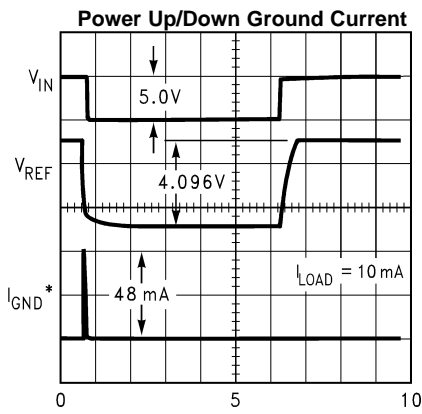

Figure 4.

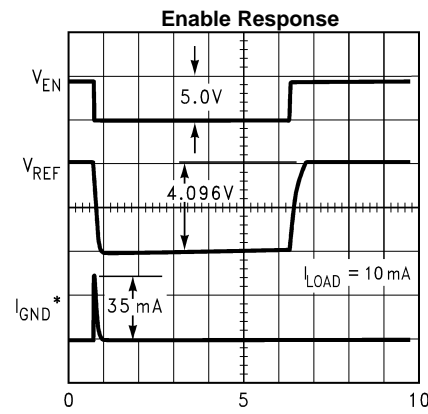

Figure 5.

\* The 1μF output capacitor is actively discharged to ground. See [ON/OFF OPERATION](#) section for more details.

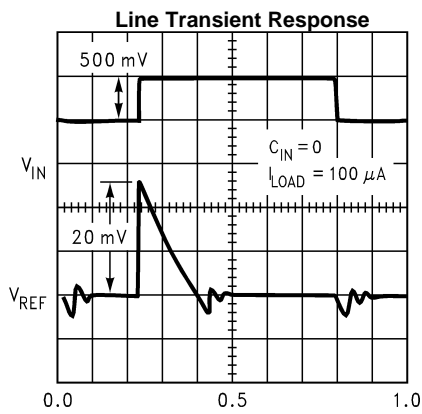

Figure 6.

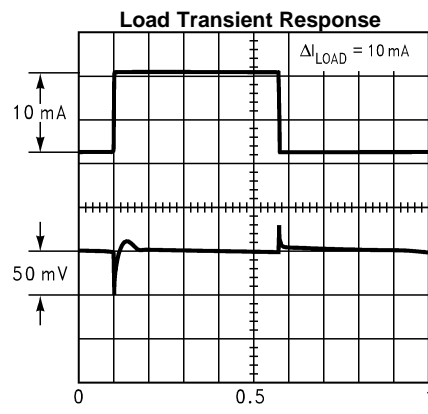

Figure 7.

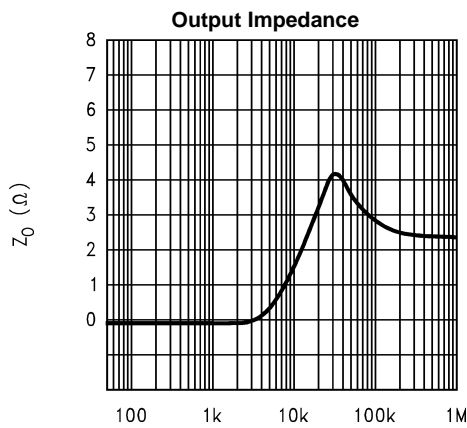

Figure 8.

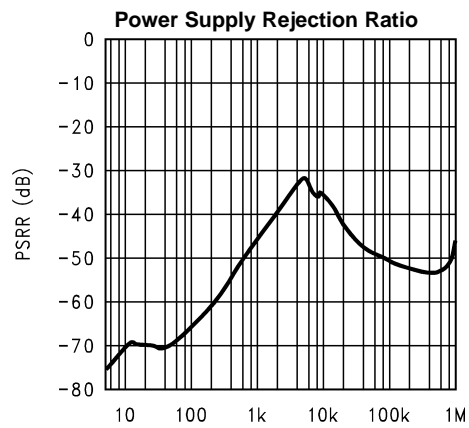
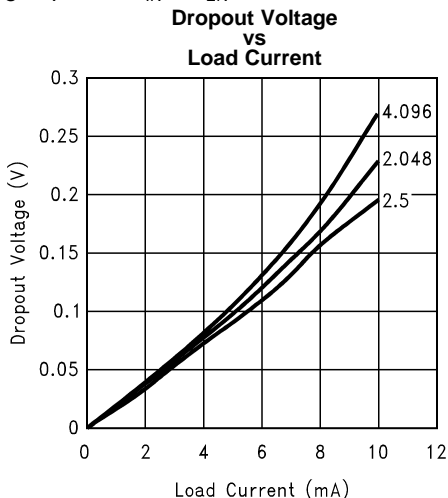

Figure 9.

**LM4140 Typical Performance Characteristics (continued)**

Unless otherwise specified,  $T_A = 25^\circ\text{C}$ , No Load,  $C_{OUT} = 1\mu\text{F}$ ,  $V_{IN} = 3.0\text{V}$  for LM4140-1.024 and LM4140-1.250, and 5V for all other voltage options.  $V_{IN} = V_{EN}$ .



Note: 1.024V and 1.250V options require 1.8V supply.  
**Figure 10.**

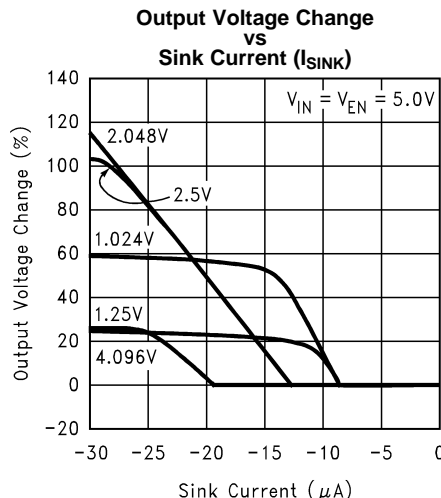

**Figure 11.**

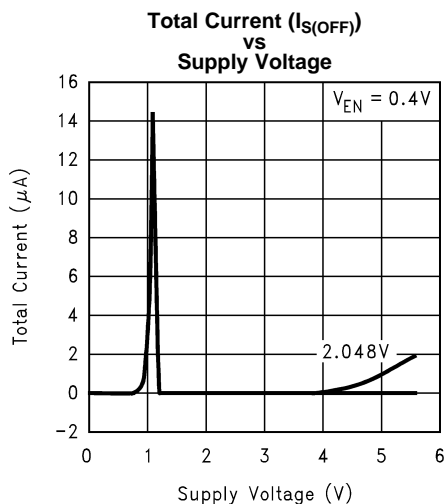

**Figure 12.**

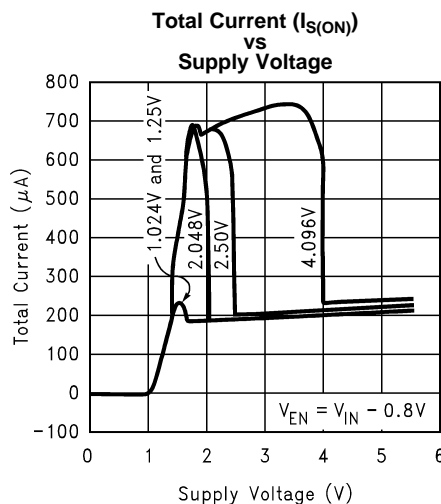

**Figure 13.**

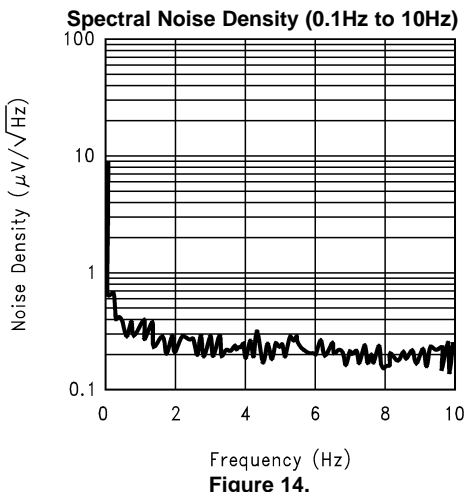

**Figure 14.**

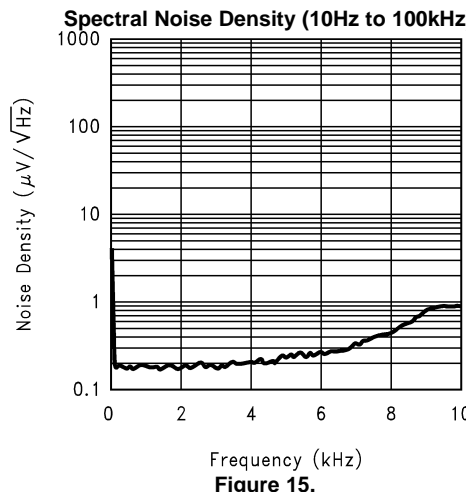

**Figure 15.**

**LM4140 Typical Performance Characteristics (continued)**

Unless otherwise specified,  $T_A = 25^\circ\text{C}$ , No Load,  $C_{OUT} = 1\mu\text{F}$ ,  $V_{IN} = 3.0\text{V}$  for LM4140-1.024 and LM4140-1.250, and 5V for all other voltage options.  $V_{IN} = V_{EN}$ .

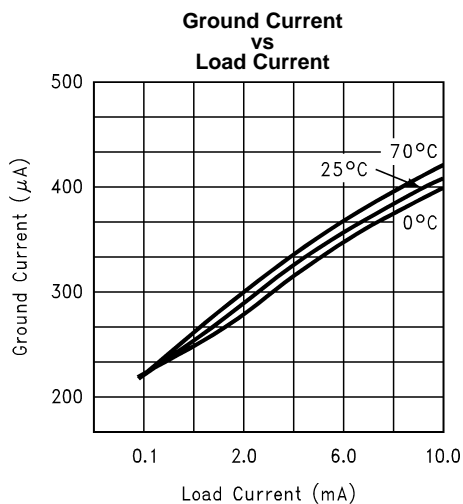

Figure 16.

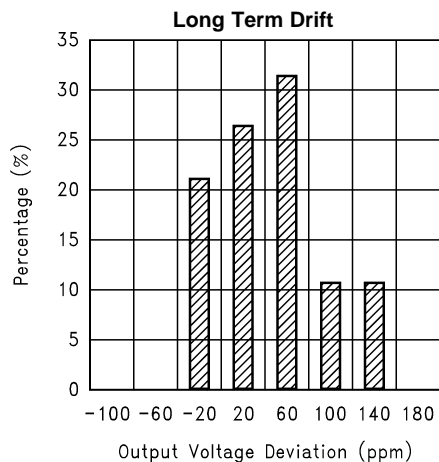

Figure 17.

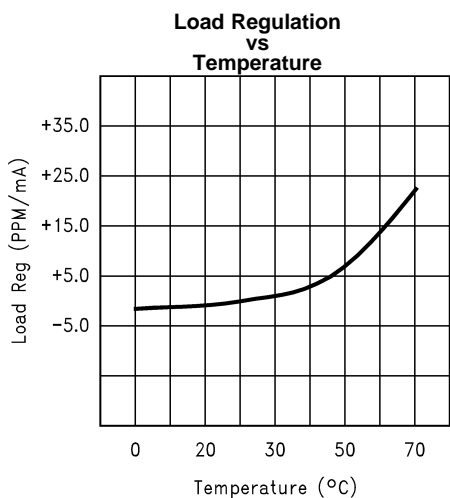

Figure 18.

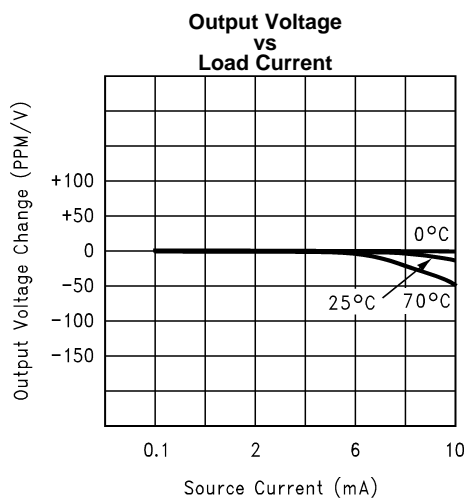

Figure 19.

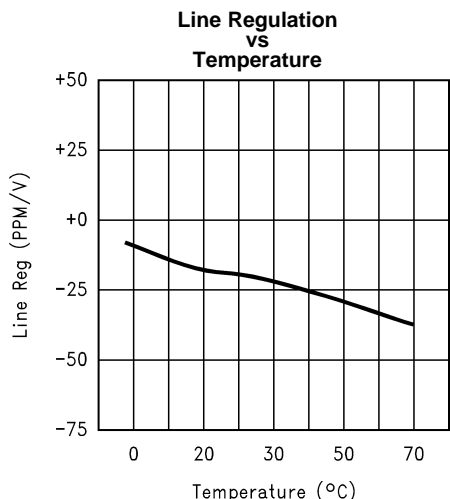

Figure 20.

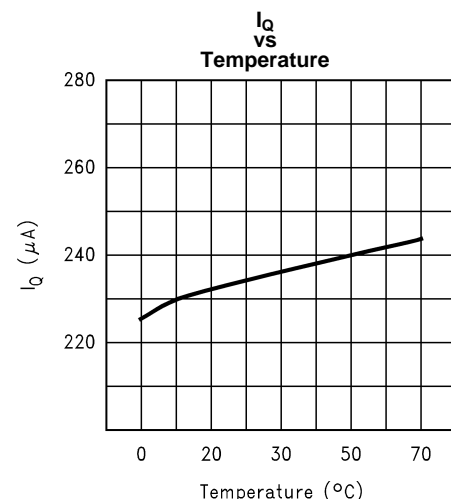

Figure 21.

**LM4140 Typical Performance Characteristics (continued)**

Unless otherwise specified,  $T_A = 25^\circ\text{C}$ , No Load,  $C_{OUT} = 1\mu\text{F}$ ,  $V_{IN} = 3.0\text{V}$  for LM4140-1.024 and LM4140-1.250, and 5V for all other voltage options.  $V_{IN} = V_{EN}$ .

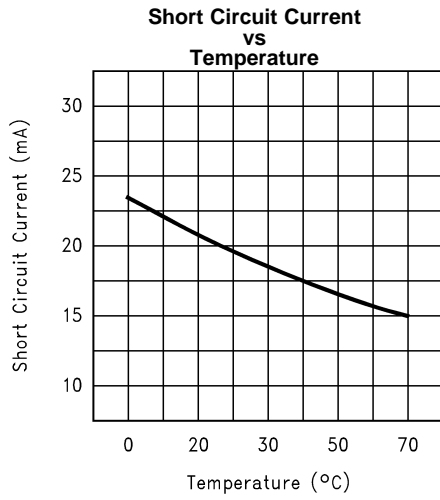

Figure 22.

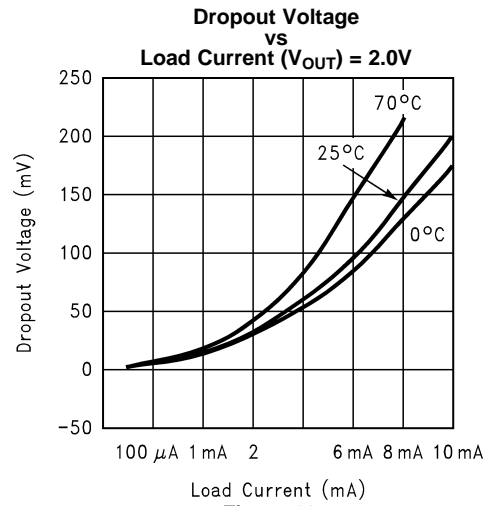

Figure 23.



## APPLICATION HINTS

### INPUT CAPACITORS

Although not always required, an input capacitor is recommended. A supply bypass capacitor on the input assures that the reference is working from a source with low impedance, which improves stability. A bypass capacitor can also improve transient response by providing a reservoir of stored energy that the reference can utilize in case where the load current demand suddenly increases. The value used for  $C_{IN}$  may be used without limit. Refer to the [Typical Application](#) section for examples of input capacitors.

### OUTPUT CAPACITORS

The LM4140 requires a  $1\mu\text{F}$  (nominally) output capacitor for loop stability (compensation) as well as transient response. During the sudden changes in load current demand, the output capacitor must source or sink current during the time it takes the control loop of the LM4140 to respond.

This capacitor must be selected to meet the requirements of minimum capacitance and equivalent series resistance (ESR) range.

In general, the capacitor value must be at least  $0.2\mu\text{F}$  (over the actual ambient operating temperature), and the ESR must be within the range indicated in [Figure 24](#), [Figure 25](#) and [Figure 26](#).

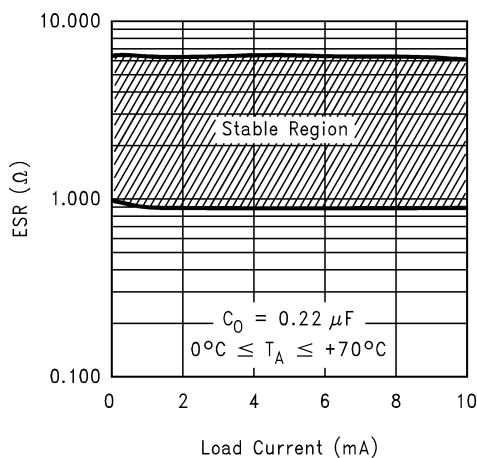

Figure 24.  $0.22\ \mu\text{F}$  ESR Range

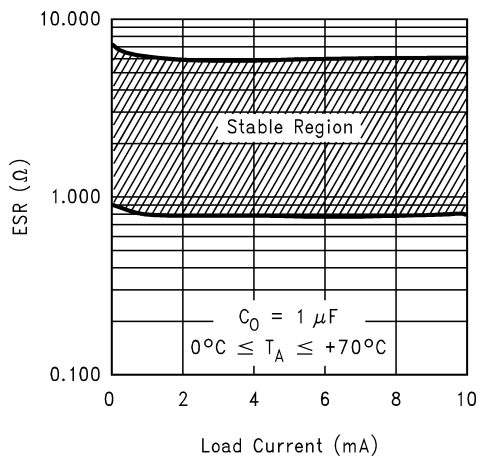
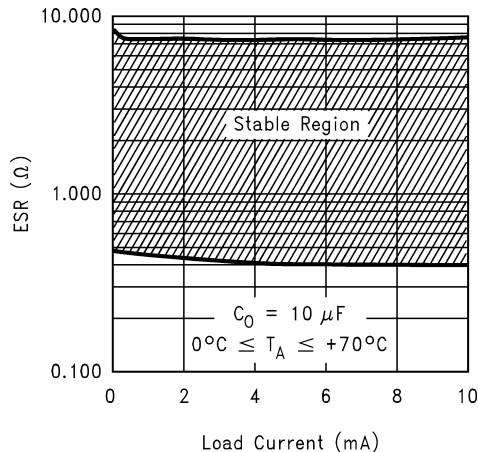

Figure 25.  $1\ \mu\text{F}$  ESR Range



**Figure 26. 10  $\mu\text{F}$  ESR Range**

## TANTALUM CAPACITORS

Surface-mountable solid tantalum capacitors offer a good combination of small physical size for the capacitance value, and ESR in the range needed for by the LM4140. The results of testing the LM4140 stability with surface mount solid tantalum capacitors show good stability with values in the range of 0.1  $\mu\text{F}$ . However, optimum performance is achieved with a 1  $\mu\text{F}$  capacitor.

Tantalum capacitors that have been verified as suitable for use with the LM4140 are shown in [Table 1](#).

**Table 1. Surface-Mount Tantalum Capacitor Selection Guide**

1 $\mu\text{F}$ Surface-Mount Tantalums	
Manufacturer	Part Number
Kemet	T491A105M010AS
NEC	NRU105N10
Siemens	B45196-E3105-K
Nichicon	F931C105MA
Sprague	293D105X0016A2T
2.2 $\mu\text{F}$ Surface-Mount Tantalums	
Kemet	T491A225M010AS
NEC	NRU225M06
Siemens	B45196/2.2/10/10
Nichicon	F930J225MA
Sprague	293D225X0010A2T

## ALUMINIUM ELECTROLYTIC CAPACITORS

Although probably not a good choice for a production design, because of relatively large physical size, an aluminium electrolytic capacitor can be used in the design prototype for an LM4140 reference. A 1  $\mu\text{F}$  capacitor meeting the ESR conditions can be used. If the operating temperature drops below 0°C, the reference may not remain stable, as the ESR of the aluminium electrolytic capacitor will increase, and may exceed the limits indicated in the figures.

## MULTILAYER CERAMIC CAPACITORS

Surface-mountable multilayer ceramic capacitors may be an attractive choice because of their relatively small physical size and excellent RF characteristics.

However, they sometimes have an ESR values lower than the minimum required by the LM4140, and relatively large capacitance change with temperature. The manufacturer's datasheet for the capacitor should be consulted before selecting a value. Test results of LM4140 stability using multilayer ceramic capacitors show that a minimum of 0.2 $\mu$ F is usually needed.

Multilayer ceramic capacitors that have been verified as suitable for use with the LM4140 are shown in [Table 2](#).

**Table 2. Surface-Mount Ceramic Capacitors Selection Guide**

2.2 $\mu$ F Surface-Mount Ceramic	
Manufacturer	Part Number
Token	1E225ZY5U-C203
Murata	GRM42-6Y5V225Z16
4.7 $\mu$ F Surface-Mount Ceramic	
Token	1E475ZY5U-C304

## REVERSE CURRENT PATH

The P-channel Pass transistor used in the LM4140 has an inherent diode connected between the  $V_{IN}$  and  $V_{REF}$  pins (see diagram below).

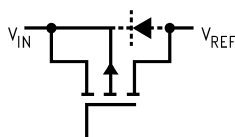

Forcing the output to voltages higher than the input, or pulling  $V_{IN}$  below voltage stored on the output capacitor by more than a  $V_{be}$ , will forward bias this diode and current will flow from the  $V_{REF}$  terminal to  $V_{IN}$ . No damage to the LM4140 will occur under these conditions as long as the current flowing into the output pin does not exceed 50mA.

## ON/OFF OPERATION

The LM4140 is designed to quickly reduce both  $V_{REF}$  and  $I_Q$  to zero when turned-off.  $V_{REF}$  is restored in less than 200 $\mu$ s when turned-on. During the turn-off, the charge across the output capacitor is discharged to ground through internal circuitry.

The LM4140 is turned-off by pulling the enable input low, and turned-on by driving the input high. If this feature is not to be used, the enable pin should be tied to the  $V_{IN}$  to keep the reference on at all times (the enable pin must not be left floating).

To ensure proper operation, the signal source used to drive the enable pin must be able to swing above and below the specified high and low voltage thresholds which ensure an ON or OFF state (see [LM4140 Electrical Characteristics](#)).

The ON/OFF signal may come from either a totem-pole output, or an open-collector output with pull-up resistor to the LM4140 input voltage. This high-level voltage may exceed the LM4140 input voltage, but must remain within the Absolute Maximum Rating for the enable pin.

## OUTPUT ACCURACY

Like all references, either series or shunt, the after assembly accuracy is made up of primarily three components: initial accuracy itself, thermal hysteresis and effects of the PCB assembly stress.

LM4140 provides an excellent output initial accuracy of 0.1% and temperature coefficient of 6ppm/ $^{\circ}$ C (B Grade).

For best accuracy and precision, the LM4140 junction temperature should not exceed 70 $^{\circ}$ C.

The thermal hysteresis curve on this datasheet are performance characteristics of three typical parts selected at random from a sample of 40 parts.

Parts are mounted in a socket to minimize the effect of PCB's mechanical expansion and contraction. Readings are taken at 25 $^{\circ}$ C following multiple temperature cycles to 0 $^{\circ}$ C and 70 $^{\circ}$ C. The labels on the X axis of the graph indicates the device temperature cycle prior to measurement at 25 $^{\circ}$ C.

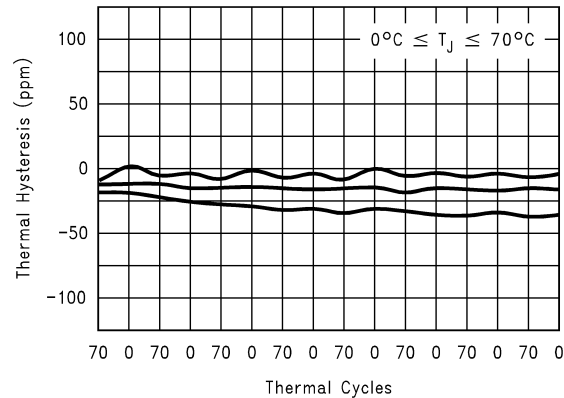

**Figure 27. Typical Thermal Hysteresis**

The mechanical stress due to the PCB's mechanical and thermal stress can cause an output voltage shift more than the true thermal coefficient of the device. References in surface mount packages are more susceptible to these stresses because of the small amount of plastic molding which support the leads.

Following the recommendations on [PCB LAYOUT CONSIDERATION](#) section can minimize the mechanical stress on the device.

### PCB LAYOUT CONSIDERATION

The simplest ways to reduce the stress related shifts are:

1. Mounting the device near the edges or the corners of the board where mechanical stress is at its minimum. The center of the board generally has the highest mechanical and thermal expansion stress.
2. Mechanical isolation of the device by creating an island by cutting a U shape slot on the PCB for mounting the device. This approach would also provide some thermal isolation from the rest of the circuit.

[Figure 28](#) is a recommended printed board layout with a slot cut on three sides of the circuit layout to serve as a strain relief.

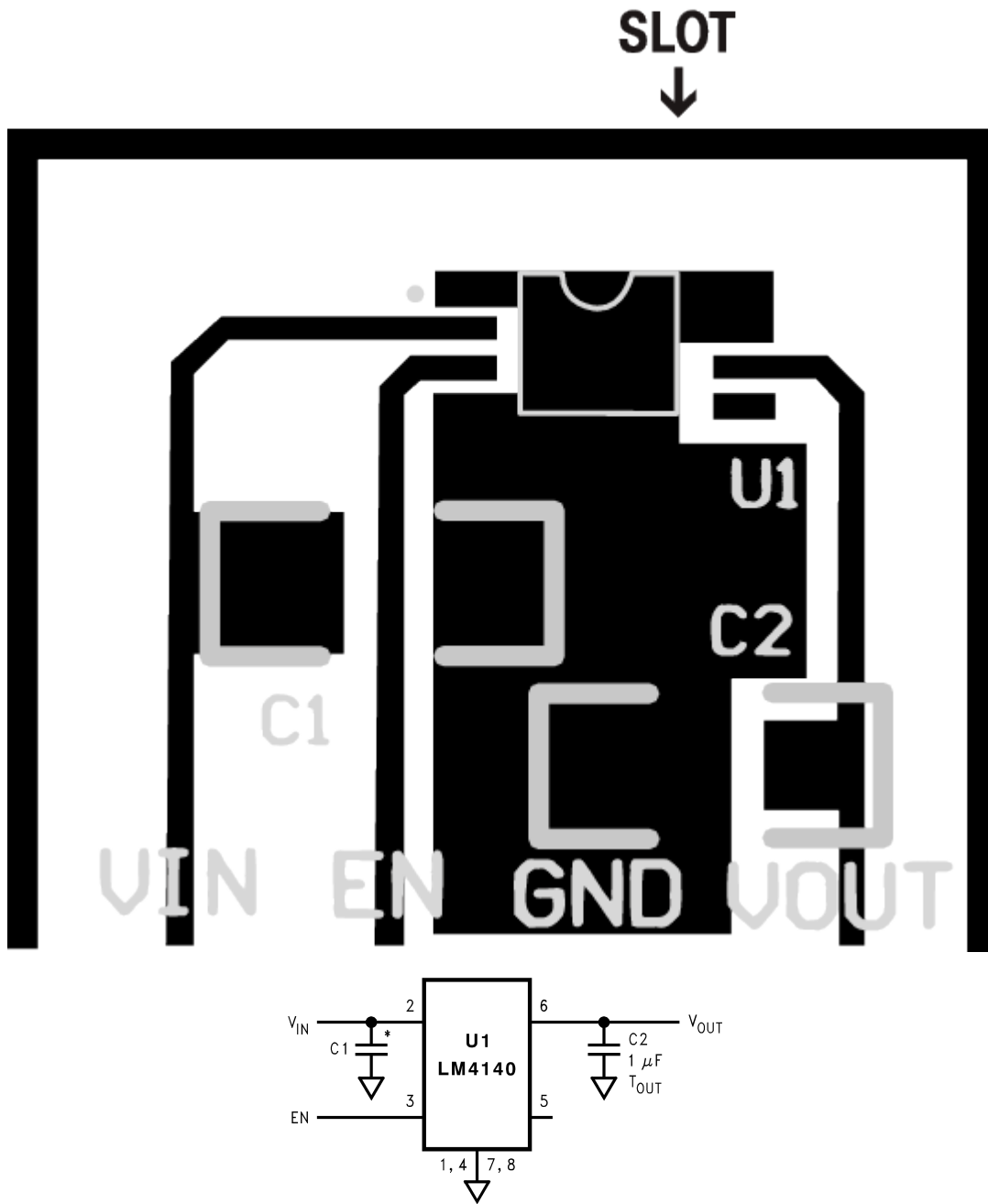

**Figure 28. Suggested PCB Layout with Slot**

Typical Application Circuits

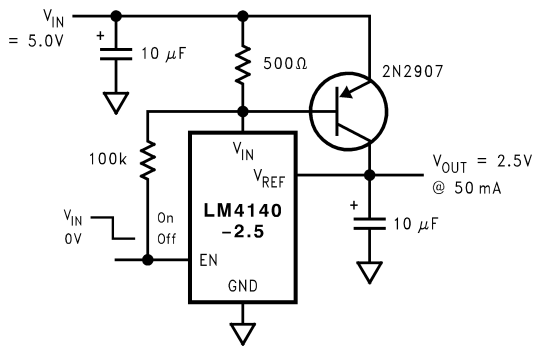

Figure 29. Boosted Output Current

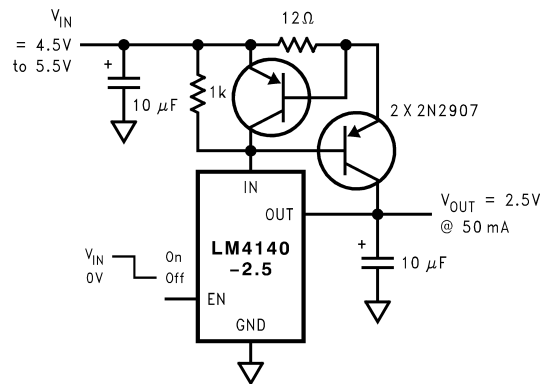

Figure 30. Boosted Output Current with Current Limiter

\* Low Noise Op Amp such as OP-27

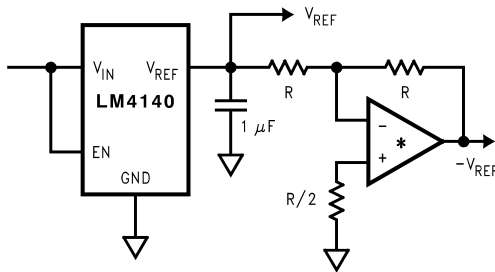

Figure 31. Complimentary Outputs

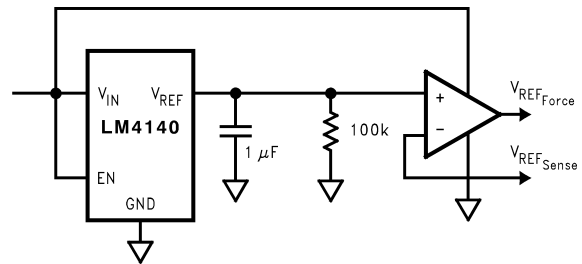
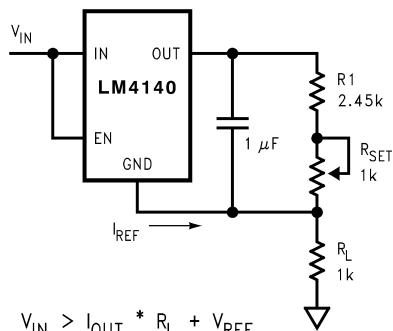

Figure 32. Voltage Reference with Force and Sense Output



$$V_{IN} > I_{OUT} * R_L + V_{REF}$$

$$I_{OUT} = (V_{REF} / (R_1 + R_{SET})) + I_{REF}$$

R1 = 2.45k for  
I<sub>L</sub> = 1 mA using LM4120-2.5

Figure 33. Precision Programmable Current Source

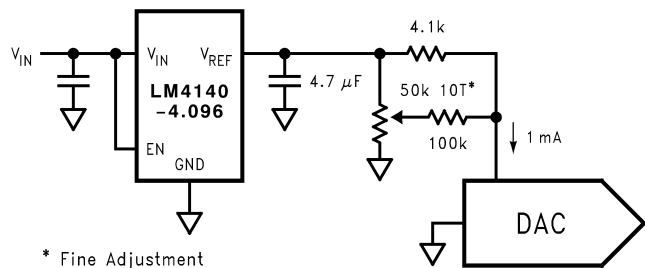

\* Fine Adjustment

Figure 34. Precision DAC Reference



## REVISION HISTORY

Changes from Revision D (April 2013) to Revision E	Page
• Changed layout of National Data Sheet to TI format .....	<a href="#">15</a>



**PACKAGING INFORMATION**

Orderable Device	Status (1)	Package Type	Package Drawing	Pins	Package Qty	Eco Plan (2)	Lead/Ball Finish (6)	MSL Peak Temp (3)	Op Temp (°C)	Device Marking (4/5)	Samples
LM4140ACM-1.0/NOPB	ACTIVE	SOIC	D	8	95	Green (RoHS & no Sb/Br)	CU SN	Level-1-260C-UNLIM	0 to 70	4140A CM1.0	<a href="#">Samples</a>
LM4140ACM-1.2	NRND	SOIC	D	8	95	TBD	Call TI	Call TI	0 to 70	4140A CM1.2	
LM4140ACM-1.2/NOPB	ACTIVE	SOIC	D	8	95	Green (RoHS & no Sb/Br)	CU SN	Level-1-260C-UNLIM	0 to 70	4140A CM1.2	<a href="#">Samples</a>
LM4140ACM-2.0	NRND	SOIC	D	8	95	TBD	Call TI	Call TI	0 to 70	4140A CM2.0	
LM4140ACM-2.0/NOPB	ACTIVE	SOIC	D	8	95	Green (RoHS & no Sb/Br)	CU SN	Level-1-260C-UNLIM	0 to 70	4140A CM2.0	<a href="#">Samples</a>
LM4140ACM-2.5	NRND	SOIC	D	8	95	TBD	Call TI	Call TI	0 to 70	4140A CM2.5	
LM4140ACM-2.5/NOPB	ACTIVE	SOIC	D	8	95	Green (RoHS & no Sb/Br)	CU SN	Level-1-260C-UNLIM	0 to 70	4140A CM2.5	<a href="#">Samples</a>
LM4140ACM-4.1	NRND	SOIC	D	8	95	TBD	Call TI	Call TI	0 to 70	4140A CM4.1	
LM4140ACM-4.1/NOPB	ACTIVE	SOIC	D	8	95	Green (RoHS & no Sb/Br)	CU SN	Level-1-260C-UNLIM	0 to 70	4140A CM4.1	<a href="#">Samples</a>
LM4140ACMX-2.5/NOPB	ACTIVE	SOIC	D	8	2500	Green (RoHS & no Sb/Br)	CU SN	Level-1-260C-UNLIM	0 to 70	4140A CM2.5	<a href="#">Samples</a>
LM4140ACMX-4.1/NOPB	ACTIVE	SOIC	D	8	2500	Green (RoHS & no Sb/Br)	CU SN	Level-1-260C-UNLIM	0 to 70	4140A CM4.1	<a href="#">Samples</a>
LM4140BCM-1.0/NOPB	ACTIVE	SOIC	D	8	95	Green (RoHS & no Sb/Br)	CU SN	Level-1-260C-UNLIM	0 to 70	4140B CM1.0	<a href="#">Samples</a>
LM4140BCM-1.2/NOPB	ACTIVE	SOIC	D	8	95	Green (RoHS & no Sb/Br)	CU SN	Level-1-260C-UNLIM	0 to 70	4140B CM1.2	<a href="#">Samples</a>
LM4140BCM-2.0/NOPB	ACTIVE	SOIC	D	8	95	Green (RoHS & no Sb/Br)	CU SN	Level-1-260C-UNLIM	0 to 70	4140B CM2.0	<a href="#">Samples</a>
LM4140BCM-2.5/NOPB	ACTIVE	SOIC	D	8	95	Green (RoHS & no Sb/Br)	CU SN	Level-1-260C-UNLIM	0 to 70	4140B CM2.5	<a href="#">Samples</a>
LM4140BCM-4.1/NOPB	ACTIVE	SOIC	D	8	95	Green (RoHS & no Sb/Br)	CU SN	Level-1-260C-UNLIM	0 to 70	4140B CM4.1	<a href="#">Samples</a>
LM4140BCMX-1.0/NOPB	ACTIVE	SOIC	D	8	2500	Green (RoHS & no Sb/Br)	CU SN	Level-1-260C-UNLIM	0 to 70	4140B CM1.0	<a href="#">Samples</a>

Orderable Device	Status (1)	Package Type	Package Drawing	Pins	Package Qty	Eco Plan (2)	Lead/Ball Finish (6)	MSL Peak Temp (3)	Op Temp (°C)	Device Marking (4/5)	Samples
LM4140BCMX-2.5/NOPB	ACTIVE	SOIC	D	8	2500	Green (RoHS & no Sb/Br)	CU SN	Level-1-260C-UNLIM	0 to 70	4140B CM2.5	<a href="#">Samples</a>
LM4140BCMX-4.1/NOPB	ACTIVE	SOIC	D	8	2500	Green (RoHS & no Sb/Br)	CU SN	Level-1-260C-UNLIM	0 to 70	4140B CM4.1	<a href="#">Samples</a>
LM4140CCM-1.0/NOPB	ACTIVE	SOIC	D	8	95	Green (RoHS & no Sb/Br)	CU SN	Level-1-260C-UNLIM	0 to 70	4140C CM1.0	<a href="#">Samples</a>
LM4140CCM-1.2/NOPB	ACTIVE	SOIC	D	8	95	Green (RoHS & no Sb/Br)	CU SN	Level-1-260C-UNLIM	0 to 70	4140C CM1.2	<a href="#">Samples</a>
LM4140CCM-2.0/NOPB	ACTIVE	SOIC	D	8	95	Green (RoHS & no Sb/Br)	CU SN	Level-1-260C-UNLIM	0 to 70	4140C CM2.0	<a href="#">Samples</a>
LM4140CCM-2.5	NRND	SOIC	D	8	95	TBD	Call TI	Call TI	0 to 70	4140C CM2.5	
LM4140CCM-2.5/NOPB	ACTIVE	SOIC	D	8	95	Green (RoHS & no Sb/Br)	CU SN	Level-1-260C-UNLIM	0 to 70	4140C CM2.5	<a href="#">Samples</a>
LM4140CCM-4.1/NOPB	ACTIVE	SOIC	D	8	95	Green (RoHS & no Sb/Br)	CU SN	Level-1-260C-UNLIM	0 to 70	4140C CM4.1	<a href="#">Samples</a>
LM4140CCMX-1.0/NOPB	ACTIVE	SOIC	D	8	2500	Green (RoHS & no Sb/Br)	CU SN	Level-1-260C-UNLIM	0 to 70	4140C CM1.0	<a href="#">Samples</a>
LM4140CCMX-1.2/NOPB	ACTIVE	SOIC	D	8	2500	Green (RoHS & no Sb/Br)	CU SN	Level-1-260C-UNLIM	0 to 70	4140C CM1.2	<a href="#">Samples</a>
LM4140CCMX-2.5/NOPB	ACTIVE	SOIC	D	8	2500	Green (RoHS & no Sb/Br)	CU SN	Level-1-260C-UNLIM	0 to 70	4140C CM2.5	<a href="#">Samples</a>
LM4140CCMX-4.1/NOPB	ACTIVE	SOIC	D	8	2500	Green (RoHS & no Sb/Br)	CU SN	Level-1-260C-UNLIM	0 to 70	4140C CM4.1	<a href="#">Samples</a>

(1) The marketing status values are defined as follows:

**ACTIVE:** Product device recommended for new designs.

**LIFEBUY:** TI has announced that the device will be discontinued, and a lifetime-buy period is in effect.

**NRND:** Not recommended for new designs. Device is in production to support existing customers, but TI does not recommend using this part in a new design.

**PREVIEW:** Device has been announced but is not in production. Samples may or may not be available.

**OBSELETE:** TI has discontinued the production of the device.

(2) Eco Plan - The planned eco-friendly classification: Pb-Free (RoHS), Pb-Free (RoHS Exempt), or Green (RoHS & no Sb/Br) - please check <http://www.ti.com/productcontent> for the latest availability information and additional product content details.

**TBD:** The Pb-Free/Green conversion plan has not been defined.

**Pb-Free (RoHS):** TI's terms "Lead-Free" or "Pb-Free" mean semiconductor products that are compatible with the current RoHS requirements for all 6 substances, including the requirement that lead not exceed 0.1% by weight in homogeneous materials. Where designed to be soldered at high temperatures, TI Pb-Free products are suitable for use in specified lead-free processes.

---

**Pb-Free (RoHS Exempt):** This component has a RoHS exemption for either 1) lead-based flip-chip solder bumps used between the die and package, or 2) lead-based die adhesive used between the die and leadframe. The component is otherwise considered Pb-Free (RoHS compatible) as defined above.

**Green (RoHS & no Sb/Br):** TI defines "Green" to mean Pb-Free (RoHS compatible), and free of Bromine (Br) and Antimony (Sb) based flame retardants (Br or Sb do not exceed 0.1% by weight in homogeneous material)

<sup>(3)</sup> MSL, Peak Temp. - The Moisture Sensitivity Level rating according to the JEDEC industry standard classifications, and peak solder temperature.

<sup>(4)</sup> There may be additional marking, which relates to the logo, the lot trace code information, or the environmental category on the device.

<sup>(5)</sup> Multiple Device Markings will be inside parentheses. Only one Device Marking contained in parentheses and separated by a "~" will appear on a device. If a line is indented then it is a continuation of the previous line and the two combined represent the entire Device Marking for that device.

<sup>(6)</sup> Lead/Ball Finish - Orderable Devices may have multiple material finish options. Finish options are separated by a vertical ruled line. Lead/Ball Finish values may wrap to two lines if the finish value exceeds the maximum column width.

**Important Information and Disclaimer:** The information provided on this page represents TI's knowledge and belief as of the date that it is provided. TI bases its knowledge and belief on information provided by third parties, and makes no representation or warranty as to the accuracy of such information. Efforts are underway to better integrate information from third parties. TI has taken and continues to take reasonable steps to provide representative and accurate information but may not have conducted destructive testing or chemical analysis on incoming materials and chemicals. TI and TI suppliers consider certain information to be proprietary, and thus CAS numbers and other limited information may not be available for release.

In no event shall TI's liability arising out of such information exceed the total purchase price of the TI part(s) at issue in this document sold by TI to Customer on an annual basis.

**TAPE AND REEL INFORMATION**

**QUADRANT ASSIGNMENTS FOR PIN 1 ORIENTATION IN TAPE**

\*All dimensions are nominal

Device	Package Type	Package Drawing	Pins	SPQ	Reel Diameter (mm)	Reel Width W1 (mm)	A0 (mm)	B0 (mm)	K0 (mm)	P1 (mm)	W (mm)	Pin1 Quadrant
LM4140ACMX-2.5/NOPB	SOIC	D	8	2500	330.0	12.4	6.5	5.4	2.0	8.0	12.0	Q1
LM4140ACMX-4.1/NOPB	SOIC	D	8	2500	330.0	12.4	6.5	5.4	2.0	8.0	12.0	Q1
LM4140BCMX-1.0/NOPB	SOIC	D	8	2500	330.0	12.4	6.5	5.4	2.0	8.0	12.0	Q1
LM4140BCMX-2.5/NOPB	SOIC	D	8	2500	330.0	12.4	6.5	5.4	2.0	8.0	12.0	Q1
LM4140BCMX-4.1/NOPB	SOIC	D	8	2500	330.0	12.4	6.5	5.4	2.0	8.0	12.0	Q1
LM4140CCMX-1.0/NOPB	SOIC	D	8	2500	330.0	12.4	6.5	5.4	2.0	8.0	12.0	Q1
LM4140CCMX-1.2/NOPB	SOIC	D	8	2500	330.0	12.4	6.5	5.4	2.0	8.0	12.0	Q1
LM4140CCMX-2.5/NOPB	SOIC	D	8	2500	330.0	12.4	6.5	5.4	2.0	8.0	12.0	Q1
LM4140CCMX-4.1/NOPB	SOIC	D	8	2500	330.0	12.4	6.5	5.4	2.0	8.0	12.0	Q1

**TAPE AND REEL BOX DIMENSIONS**

\*All dimensions are nominal

Device	Package Type	Package Drawing	Pins	SPQ	Length (mm)	Width (mm)	Height (mm)
LM4140ACMX-2.5/NOPB	SOIC	D	8	2500	367.0	367.0	35.0
LM4140ACMX-4.1/NOPB	SOIC	D	8	2500	367.0	367.0	35.0
LM4140BCMX-1.0/NOPB	SOIC	D	8	2500	367.0	367.0	35.0
LM4140BCMX-2.5/NOPB	SOIC	D	8	2500	367.0	367.0	35.0
LM4140BCMX-4.1/NOPB	SOIC	D	8	2500	367.0	367.0	35.0
LM4140CCMX-1.0/NOPB	SOIC	D	8	2500	367.0	367.0	35.0
LM4140CCMX-1.2/NOPB	SOIC	D	8	2500	367.0	367.0	35.0
LM4140CCMX-2.5/NOPB	SOIC	D	8	2500	367.0	367.0	35.0
LM4140CCMX-4.1/NOPB	SOIC	D	8	2500	367.0	367.0	35.0



## IMPORTANT NOTICE

Texas Instruments Incorporated and its subsidiaries (TI) reserve the right to make corrections, enhancements, improvements and other changes to its semiconductor products and services per JESD46, latest issue, and to discontinue any product or service per JESD48, latest issue. Buyers should obtain the latest relevant information before placing orders and should verify that such information is current and complete. All semiconductor products (also referred to herein as "components") are sold subject to TI's terms and conditions of sale supplied at the time of order acknowledgment.

TI warrants performance of its components to the specifications applicable at the time of sale, in accordance with the warranty in TI's terms and conditions of sale of semiconductor products. Testing and other quality control techniques are used to the extent TI deems necessary to support this warranty. Except where mandated by applicable law, testing of all parameters of each component is not necessarily performed.

TI assumes no liability for applications assistance or the design of Buyers' products. Buyers are responsible for their products and applications using TI components. To minimize the risks associated with Buyers' products and applications, Buyers should provide adequate design and operating safeguards.

TI does not warrant or represent that any license, either express or implied, is granted under any patent right, copyright, mask work right, or other intellectual property right relating to any combination, machine, or process in which TI components or services are used. Information published by TI regarding third-party products or services does not constitute a license to use such products or services or a warranty or endorsement thereof. Use of such information may require a license from a third party under the patents or other intellectual property of the third party, or a license from TI under the patents or other intellectual property of TI.

Reproduction of significant portions of TI information in TI data books or data sheets is permissible only if reproduction is without alteration and is accompanied by all associated warranties, conditions, limitations, and notices. TI is not responsible or liable for such altered documentation. Information of third parties may be subject to additional restrictions.

Resale of TI components or services with statements different from or beyond the parameters stated by TI for that component or service voids all express and any implied warranties for the associated TI component or service and is an unfair and deceptive business practice. TI is not responsible or liable for any such statements.

Buyer acknowledges and agrees that it is solely responsible for compliance with all legal, regulatory and safety-related requirements concerning its products, and any use of TI components in its applications, notwithstanding any applications-related information or support that may be provided by TI. Buyer represents and agrees that it has all the necessary expertise to create and implement safeguards which anticipate dangerous consequences of failures, monitor failures and their consequences, lessen the likelihood of failures that might cause harm and take appropriate remedial actions. Buyer will fully indemnify TI and its representatives against any damages arising out of the use of any TI components in safety-critical applications.

In some cases, TI components may be promoted specifically to facilitate safety-related applications. With such components, TI's goal is to help enable customers to design and create their own end-product solutions that meet applicable functional safety standards and requirements. Nonetheless, such components are subject to these terms.

No TI components are authorized for use in FDA Class III (or similar life-critical medical equipment) unless authorized officers of the parties have executed a special agreement specifically governing such use.

Only those TI components which TI has specifically designated as military grade or "enhanced plastic" are designed and intended for use in military/aerospace applications or environments. Buyer acknowledges and agrees that any military or aerospace use of TI components which have **not** been so designated is solely at the Buyer's risk, and that Buyer is solely responsible for compliance with all legal and regulatory requirements in connection with such use.

TI has specifically designated certain components as meeting ISO/TS16949 requirements, mainly for automotive use. In any case of use of non-designated products, TI will not be responsible for any failure to meet ISO/TS16949.

### Products

Audio	<a href="http://www.ti.com/audio">www.ti.com/audio</a>
Amplifiers	<a href="http://amplifier.ti.com">amplifier.ti.com</a>
Data Converters	<a href="http://dataconverter.ti.com">dataconverter.ti.com</a>
DLP® Products	<a href="http://www.dlp.com">www.dlp.com</a>
DSP	<a href="http://dsp.ti.com">dsp.ti.com</a>
Clocks and Timers	<a href="http://www.ti.com/clocks">www.ti.com/clocks</a>
Interface	<a href="http://interface.ti.com">interface.ti.com</a>
Logic	<a href="http://logic.ti.com">logic.ti.com</a>
Power Mgmt	<a href="http://power.ti.com">power.ti.com</a>
Microcontrollers	<a href="http://microcontroller.ti.com">microcontroller.ti.com</a>
RFID	<a href="http://www.ti-rfid.com">www.ti-rfid.com</a>
OMAP Applications Processors	<a href="http://www.ti.com/omap">www.ti.com/omap</a>
Wireless Connectivity	<a href="http://www.ti.com/wirelessconnectivity">www.ti.com/wirelessconnectivity</a>

### Applications

Automotive and Transportation	<a href="http://www.ti.com/automotive">www.ti.com/automotive</a>
Communications and Telecom	<a href="http://www.ti.com/communications">www.ti.com/communications</a>
Computers and Peripherals	<a href="http://www.ti.com/computers">www.ti.com/computers</a>
Consumer Electronics	<a href="http://www.ti.com/consumer-apps">www.ti.com/consumer-apps</a>
Energy and Lighting	<a href="http://www.ti.com/energy">www.ti.com/energy</a>
Industrial	<a href="http://www.ti.com/industrial">www.ti.com/industrial</a>
Medical	<a href="http://www.ti.com/medical">www.ti.com/medical</a>
Security	<a href="http://www.ti.com/security">www.ti.com/security</a>
Space, Avionics and Defense	<a href="http://www.ti.com/space-avionics-defense">www.ti.com/space-avionics-defense</a>
Video and Imaging	<a href="http://www.ti.com/video">www.ti.com/video</a>

### TI E2E Community

[e2e.ti.com](http://e2e.ti.com)