

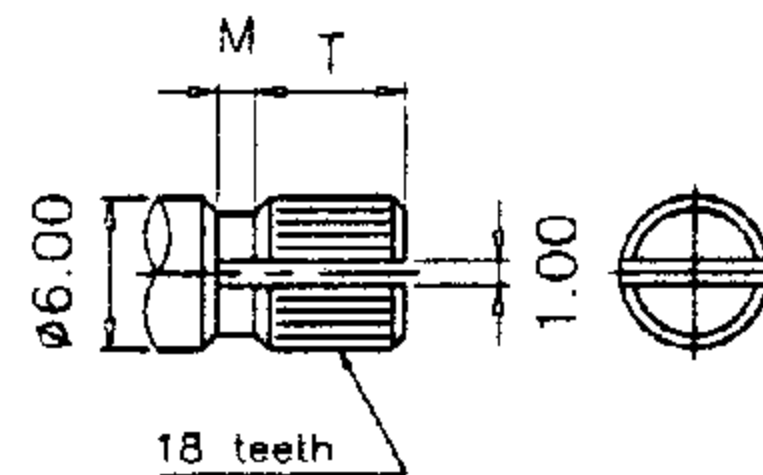

shaft shown in full
c.c.w. position

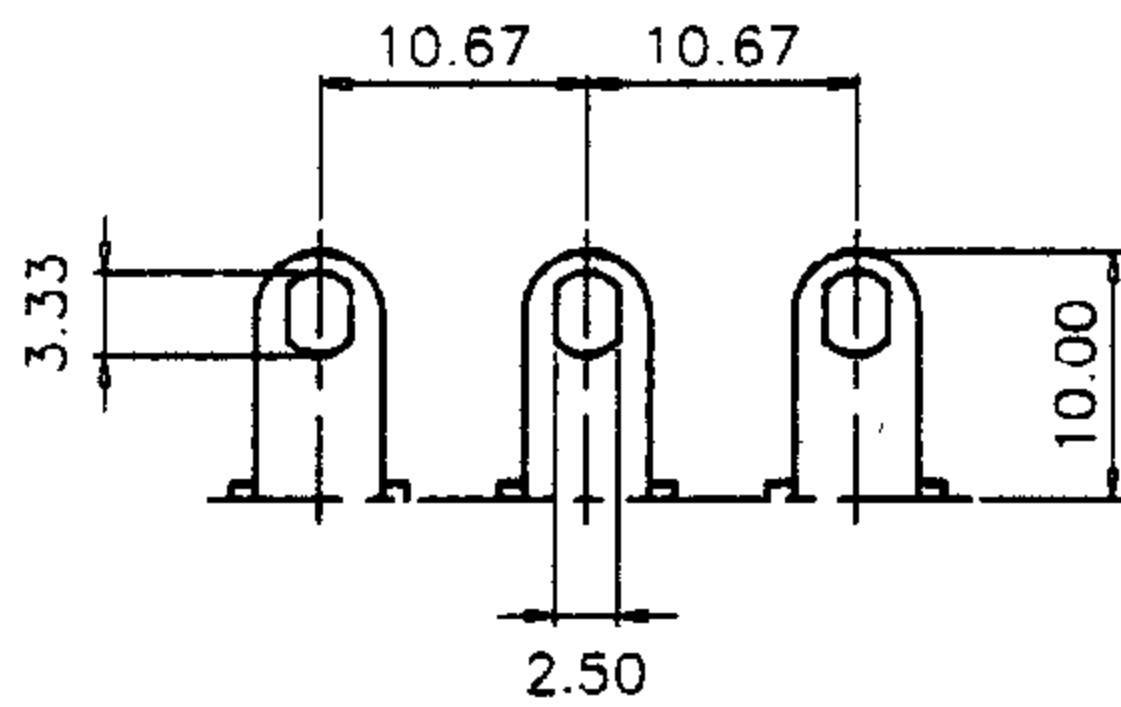

KQ TYPE:

X	4
L	25
T	12.1
M	2

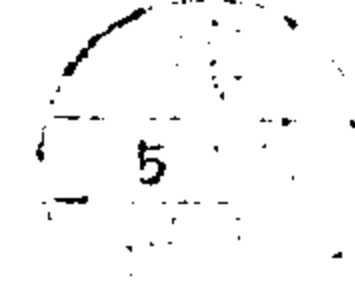
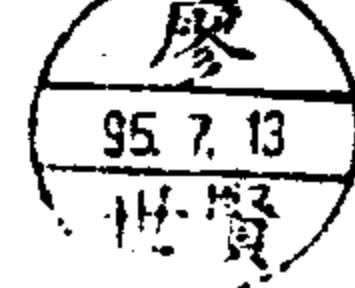
3			NAME	28-0678 5K	
2				DRAWING NO	
1			DRAWN BY		CHECK BY
NO	DATE	DESCRIPTION			
TOLERANCE		SCALE			
less than 10±0.3		2/1 6/5			
above 10-30±0.5		DIMENSION			
above 30-100±1.0		m/m			

(VRA4)

1.RESISTANCE TAPER -----	Linear Taper
2.TOTAL RESISTANCE -----	5KΩ
3.TOTAL RESISTANCE TOLERANCE-----	±20%
4.RATED POWER -----	curve B:0.5W
5.MAX. OPERATING VOLTAGE -----	curve B:500V
6.SLIDING/ROTATIONAL NOISE -----	less than 100mV
7.INSULATION RESISTANCE -----	more than 100MΩ at DC 500V
8.RESIDUAL RESISTANCE -----	10KΩ ≥R 10Ω MAX. 250KΩ >R>10KΩ 20Ω MAX. R≥250KΩ 0.1% MAX. of total resistance
9.WITHSTAND VOLTAGE -----	1 minute at AC 500V

MECHANICAL SPECIFICATION

1.TOTAL SLIDING/ROTATION ANGLE ---	300° ±5°
2.OPERATING TORQUE FORCE -----	20 ~ 200 gf.cm
3.SHAFT LEVER STRENGTH-----	PULL-PUSH 8 kgf MAX.
4.SHAFT LEVER WOBBLE -----	without bushing 0.7*L/20mm p-p MAX. with bushing 0.7*L/30mm p-p MAX.
5.SLIDE/ROTATION STOP STRENGTH ---	7 kgf.cm
6.CLICK POSITION -----	center/11/21/31/41 detent
7.CLICK TORQUE -----	rotation torque +30 ~ 300 gf.cm
8.NUT TIGHTENING STRENGTH -----	12 kgf.cm MAX.

DURABILITY

1.SLIDING/ROTATIONAL LIFE -----	10,000 cycles
2.SWITCH LIFE -----	

NOTE:

PREPARED BY REVIEWED BY APPROVED BY

