

KINGSTATE ELECTRONICS CORPORATION

Dear Sir / Madam

Date : 2021/7/30

PRODUCT CHANGE NOTICE: **KSSGJ4B20/ KSSJ4D20/KSSGI4B20-1**

The cost of the raw material and labor for above parts are continuously rising.

In order to decrease the cost and improve the quality of the parts, we would introduce a semi-automatic production line for the parts. Additionally, we have to change several materials to meet up the need of the semi-automatic production line.

We hereby announce that the part no.:

KSSGJ4B20/ KSSGJ4D20/KSSGI4B20-1







VERSION: **TKS-7066-1.4/ TKS-7082-1.5/TKS-7273-1.2**

have been changed to :

KSSGJ4B20/ KSSGJ4D20/KSSGI4B20-1

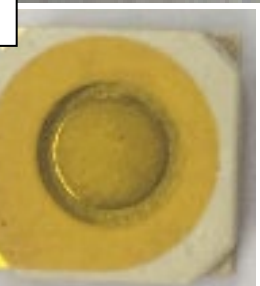
VERSION: **TKS-7066-1.5/ TKS-7082-1.6/TKS-7273-1.3**

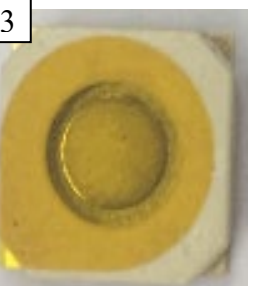
Change content	Before	After
----------------	--------	-------

<p>Top side:</p> <p><u>1.KSSGJ4B20</u></p> <p><u>□ □ □ □ □ □ □ □</u> The top appearance remains the same.</p> <p><u>2.KSSGJ4D20</u></p> <p><u>□ □ □ □ □ □ □ □</u> The top appearance remains the same.</p> <p><u>3. KSSGI4B20-1</u></p> <p><u>□ □ □ □ □ □ □ □</u> The top appearance remains the same.</p>	<p>1 </p> <p>2 </p> <p>3 </p>	<p>1 </p> <p>2 </p> <p>3 </p>
<p>Change content</p>	<p>Before</p>	<p>After</p>
<p>Bottom side:</p> <p>四个机种底部焊盘均由裸露点胶方式变更为埋设方式，贴合度更佳</p> <p>The bottom bonding pads of 4 P/N are all changed from the exposed gluing mode to the buried mode for better adhesion.</p>		
<p>Change content</p>	<p>Before</p>	<p>After</p>

外□□□□□：

1. KSSGJ4B20

□□□□□□□□□□

The size remains the same.

2. KSSGJ4D20

□□□□□□□□□□

The size remains the same.

3. KSSGI4B20-1

□□□□□□□□□□

The size remains the same.

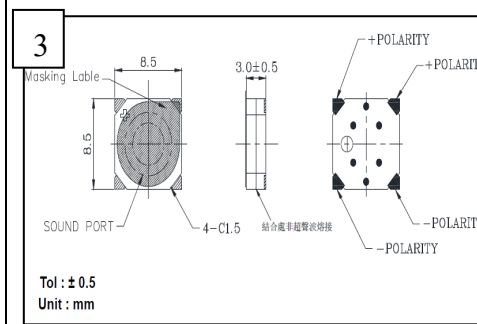
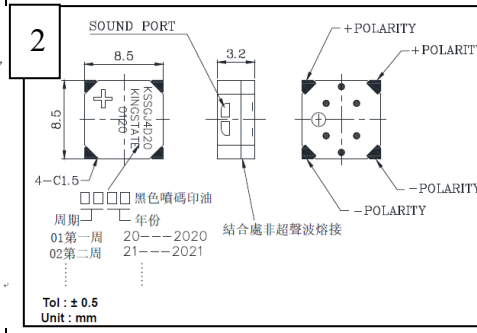
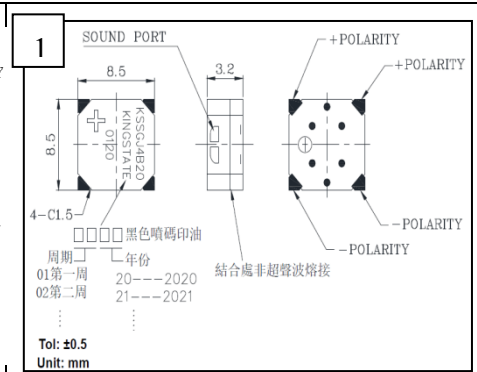
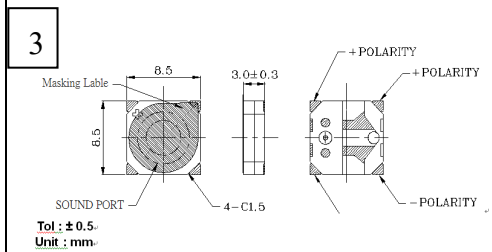
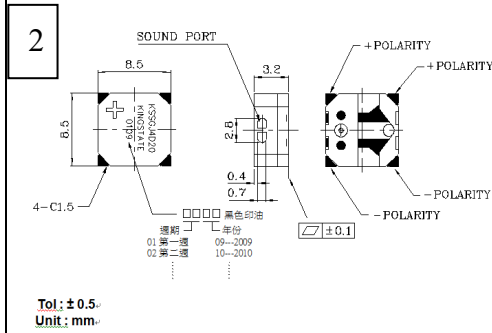
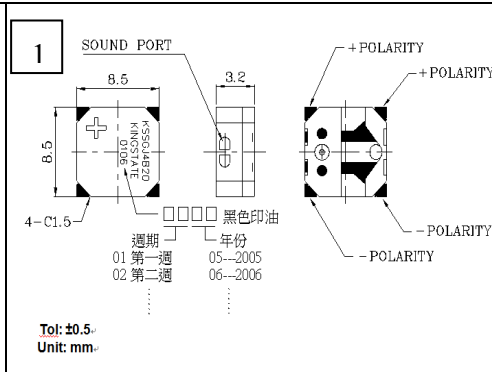

Change content

Character:

1. KSSGJ4B20

□□□□□□□□□□

The character remains the same.

2. KSSGJ4D20

□□□□□□□□□□

Before

1	Rated Voltage., 額定電壓.,	Vo-p.,	3.6.,
	Operating Volt., 操作電壓.,	Vo-p.,	3.0~5.0.,
	Mean Current., 平均耗電流.,	mA.,	Max. 80.,
	Coil Resistance., 直流阻抗.,	Ω.,	20 ± 3.,
	Sound Output., 輸出音壓.,	dBA.,	Min.90., (Typical 97).,
	Rated Frequency., 額定頻率.,	Hz.,	2730.,

2	Rated Voltage., 額定電壓.,	Vo-p.,	3.6.,
	Operating Volt., 操作電壓.,	Vo-p.,	3.0~5.0.,
	Mean Current., 平均耗電流.,	mA.,	Max. 80.,
	Coil Resistance., 直流阻抗.,	Ω.,	20 ± 3.,
	Sound Output., 輸出音壓.,	dBA.,	Min.90., (Typical 97).,
	Rated Frequency., 額定頻率.,	Hz.,	3100 .,

After

1	Rated Voltage., 額定電壓.,	Vo-p.,	3.6.,
	Operating Volt., 操作電壓.,	Vo-p.,	3.0~5.0.,
	Mean Current., 平均耗電流.,	mA.,	Max. 80.,
	Coil Resistance., 直流阻抗.,	Ω.,	20 ± 3.,
	Sound Output., 輸出音壓.,	dBA.,	Min.90., (Typical 97).,
	Rated Frequency., 額定頻率.,	Hz.,	2730.,

2	Rated Voltage., 額定電壓.,	Vo-p.,	3.6.,
	Operating Volt., 操作電壓.,	Vo-p.,	3.0~5.0.,
	Mean Current., 平均耗電流.,	mA.,	Max. 80.,
	Coil Resistance., 直流阻抗.,	Ω.,	20 ± 3.,
	Sound Output., 輸出音壓.,	dBA.,	Min.90., (Typical 97).,
	Rated Frequency., 額定頻率.,	Hz.,	3100 .,

<p>The character remains the same..</p> <p>3. KSSGI4B20-1</p> <p>□ □ □ □ □ □ □ 全 □ □</p> <p>The character remains the same..</p>	3	Rated Voltage., 額定電壓.,	Vo-p.,	3.6.,	3	Rated Voltage., 額定電壓.,	Vo-p.,	3.6.,
		Operating Volt., 操作電壓.,	Vo-p.,	3.0~5.0.,		Operating Volt., 操作電壓.,	Vo-p.,	3.0~5.0.,
		Mean Current., 平均耗電流.,	mA.,	Max 80.,		Mean Current., 平均耗電流.,	mA.,	Max 80.,
		Coil Resistance., 直流阻抗.,	Ω.,	20 ± 3.,		Coil Resistance., 直流阻抗.,	Ω.,	20 ± 3.,
		Sound Output., 輸出音壓.,	dBA.,	Min 85., (Typical 90).,		Sound Output., 輸出音壓.,	dBA.,	Min 85., (Typical 90).,
		Rated Frequency., 額定頻率.,	Hz.,	2730 .,		Rated Frequency., 額定頻率.,	Hz.,	2730 .,

Estimated Change date: It's expected to start in November, 2021

Previous spec shipment should not exceed 3 months from PCN notice.

More support and information will be provided upon your solicitation.

Sincerely yours

maxiangling

KINGSTATE ELECTRONICS CO

TEL: 86-769-83183457 FAX: 86-769-83183754

www.kingstate.com.tw
