

Sample image



Datasheet





Article number: 70005500

Designation: CA20.A251.FT2

Description: Switch

IEC 60947-3 EN 60947-3, VDE 0660 Teil 107						
Märkdriftspänning Ui						
<i>Spänning (V) AC / DC</i>						
690 AC / DC						
Märkdriftström vid konstant drift						
<i>Ström (A)</i>	<i>Omgivningstemperatur (°C)</i>	<i>Temperatur topp (°C)</i>	<i>ytterligare krav</i>			
25	55	60	Omgivningstemperatur +55°C under 24 timmar med toppar upp till +60°C			
Märkdriftström Ie						
<i>Urvals kriterie</i>						
<i>Spänning (V)</i>						<i>Ström (A)</i>
AC-15						220 - 240
AC-15						380 - 440
Märkdrifteffekt						
<i>Urvals kriterie</i>						
<i>Spänning (V)</i>		<i>No. of phases</i>		<i>No. of poles</i>		<i>Effekt (kW)</i>
AC-3		220 - 240		3		4
AC-3		380 - 440		3		7,50
AC-3		660 - 690		3		7,50
AC-3		220 - 240		1		3
AC-3		380 - 440		1		3,70
AC-23A		220 - 240		3		5,50
AC-23A		380 - 440		3		11
AC-23A		660 - 690		3		11
AC-23A		220 - 240		1		3
AC-23A		380 - 440		1		5,50
Max försäkring, IEC						
<i>Säkringskarakteristik</i>						<i>Ström (A)</i>
gG						35
<i>Antal säkringar</i>						
						1
UL60947-4-1 , UL508						
Nominal Voltage						
<i>Spänning (V) AC / DC</i>						
600 AC						
Märkdriftspänning Ui						
<i>Spänning (V) AC / DC</i>						
600 AC						
Rated thermal current						
<i>Ström (A)</i>						
30						
<i>Omgivningstemperatur (°C) Additional Text</i>						
0 - 40 --						
Horsepower rating						
<i>Across-the-Line Motor Starting</i>						
<i>Spänning (V)</i>		<i>No. of phases</i>		<i>No. of poles</i>		<i>Power (HP)</i>
Reversing		110 - 120		1 2		0,33
Reversing		220 - 240		1 2		0,75
Reversing		277 - 277		1 2		1
Reversing		415 - 415		1 2		1,50
Reversing		440 - 480		1 2		2
Reversing		550 - 600		1 2		2
Reversing		110 - 120		3 3		1
Reversing		220 - 240		3 3		2
Reversing		415 - 415		3 3		3
Reversing		440 - 480		3 3		5
Reversing		550 - 600		3 3		5
DOL		110 - 120		1 2		1,50
DOL		220 - 240		1 2		3
DOL		277 - 277		1 2		3
DOL		415 - 415		1 2		3
DOL		440 - 480		1 2		5
DOL		550 - 600		1 2		5
DOL		110 - 120		3 3		3
DOL		220 - 240		3 3		7,50
DOL		415 - 415		3 3		7,50
DOL		440 - 480		3 3		10
DOL		550 - 600		3 3		10
						40

Pilot duty rating code						
Duty Code						
A600						
SCCR / Max. fuse rating						
Conditions of acceptability						
These devices are suitable for use on circuits capable of delivering not more than 5000 rms symmetrical amperes, 600V ac max. when protected by Class RK1 fuses. Manual Motor Controllers when intended for use as a motor disconnect are suitable for use on a circuit capable of delivering not more than 5000 rms symmetrical amperes, 600V ac max. when protected by 30A Class J time delay fuses.						
Temp. rating of wire						
Temperature rating (°C)			Ström (A) Text			
75			– Use copper wire only			
Connecting instructions						
Markings						
När brytaren används som säkerhetsbrytare skall den vara utrustad med vred som är låsbart i läge "0".						
General Use						
AC / DC	Spänning (V)	Ström (A)	No. of phases	No. of poles	No. of contacts in series	
AC	600	30	1	2	1	
AC	600	30	3	3	1	
CSA						
Nominal Voltage						
			Spänning (V) AC / DC			
			600 AC			
Märkdriftspänning Ui						
			Spänning (V) AC / DC			
			600 AC			
Rated thermal current						
			Ström (A)		Omgivningstemperatur (°C) Additional Text	
			30		0 - 40 –	
Horsepower rating						
Across-the-Line Motor Starting						
	Spänning (V)	No. of phases	No. of poles	Power (HP)	Ambient temperature [°C]	
DOL	110 - 120	1	2	1,50	40	
DOL	220 - 240	1	2	3	40	
DOL	277 - 277	1	2	3	40	
DOL	415 - 415	1	2	5	40	
DOL	440 - 480	1	2	5	40	
DOL	550 - 600	1	2	5	40	
DOL	110 - 120	3	3	3	40	
DOL	220 - 240	3	3	7,50	40	
DOL	415 - 415	3	3	10	40	
DOL	440 - 480	3	3	10	40	
DOL	550 - 600	3	3	10	40	
Pilot duty rating code						
Duty Code						
A600						
Temp. rating of wire						
Temperature rating (°C)			Ström (A) Text			
75			– only			
General Use						
AC / DC	Spänning (V)	Ström (A)	No. of phases	No. of poles	No. of contacts in series	
AC	600	30	1	1	1	
GENERAL TECHNICAL INFORMATION						
Tightening torque of screws						
			tightening torque (Nm)		tightening torque (lb-in)	
			1		9	
Stripping length						
			Length (mm) –			
			9 STRIPPINGLENGTH			
Size of conductor						
composition of conductor	Min. / Max. value	No. of conductor per terminal		Cross section (mm ²) or (AWG/kcmil)	Material of the wire	
solid wire	Min.	1		0,75mm ²	Copper	
solid wire	Min.	2		0,75mm ²	Copper	
flexible wire	Min.	1		1,5mm ²	Copper	
flexible wire	Max.	2		AWG 12	Copper	
flexible wire	Max.	2		4mm ²	Copper	
flexible wire	Min.	2		1,5mm ²	Copper	
Single-core or stranded wire	Max.	2		AWG 10	Copper	
Single-core or stranded wire	Max.	2		4mm ²	Copper	
flexible wire with ferrule according to DIN 46228	Min.	1		1mm ²	Copper	
flexible wire with ferrule according to DIN 46228	Max.	2		2,5mm ²	Copper	
flexible wire with ferrule according to DIN 46228	Min.	2		1mm ²	Copper	
Approptions						
Specification						Marking
EAC						
CE marking						

Approbations		Marking
Specification		
UK Directives		
CSA C.22.2 No.14		
GB/T14048.3		
Rekomenderad skruvmejsel		
Typ av skruvmejsel	Value	
Stjärnskruvmejsel	PH1	
Slot screwdriver according to DIN 5264	0,8x5,5	
General Information		
Text		
<ul style="list-style-type: none"> - Smörjning och behandling av kontaktarna är förbjuden. - Inkoppling och service av strömställaren får endast utföras av behörig personal. Strömställaren är underhållsfri. - Använd endast kopparkabel. Kabeln får inte förtennas. - Alla anslutningsskruvar måste dras med rekommenderat moment, även de som inte används då det kan finnas interna överkopplingar. - Vid installation av strömställaren skall kontrolleras att kryp- och luftavstånd motsvarar gällande föreskrifter. 		
Waste Electrical & Electronic Equipment (WEEE)		
Picture name	Description	
	Do not throw in the trash as care must be taken to ensure environmentally sound disposal and recycling. Please either use an environmentally friendly waste disposal company; return to the supplier for disposal; or return direct to the manufacturer, Kraus & Naimer. You can find local Kraus & Naimer offices at www.krausnaimer.com	
Proposition 65		
Picture name	Description	
	WARNING: This product can expose you to chemicals including nickel and lead, which is known to the State of California to cause cancer. For more information go to www.P65Warnings.ca.gov .	

Classification Contact: Rigid contact bridge
Classification Contact Mat: Silver
Classification Terminal: Screw terminal

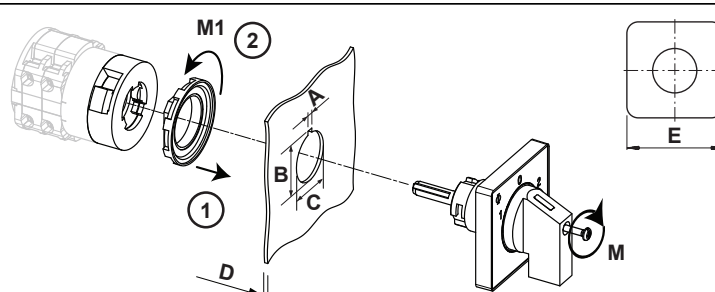
Mounting-FT2		
		
Skyddsklass frontpanel, IP		IP66, IP67, IP69k
Stages		1,00 - 12,00
A	H	3,20 mm
A+_tol.	H	0,20 mm
A-_tol.	H	0,00 mm
B	H	24,10 mm
B+_tol.	H	0,40 mm
B-_tol.	H	0,00 mm
C	Ø	22,30 mm
C+_tol.	Ø	0,40 mm
C-_tol.	Ø	0,00 mm
D	H	<= 6,00 mm
E	□	48,00 mm
M	↺	0,50 Nm
M1	↺	1,80 Nm

Wiring diagram

CA20.A251.FT2

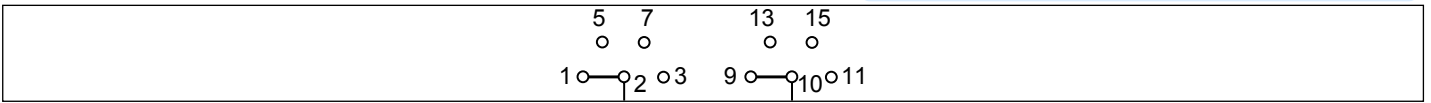

Switch program

CA20.A251.FT2

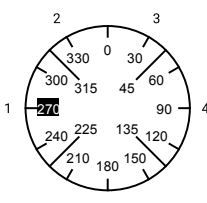
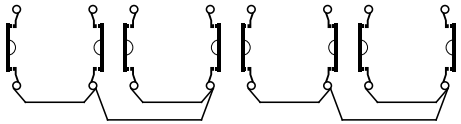
 Kraus & Naimer		CA20				A251				Page 1 of 1			
		1	3	5	7	9	11	13	15	17	19	21	23
Face Plate 													
Switching Angle <input type="text" value="60"/> Total switching Angle <input type="text" value="180"/>		2	4	6	8	10	12	14	16	18	20	22	24
1	270	■				■							
	285												
	300												
	315												
2	330			■						■			
	345												
	0												
	15												
3	30				■						■		
	45												
	60												
	75												
4	90	■											
	105												
	120												
	135												
	150												
	165												
	180												
	195												
	210												
	225												
	240												
	255												

Version: 74

Face plate

S0.F077/A10.E1L

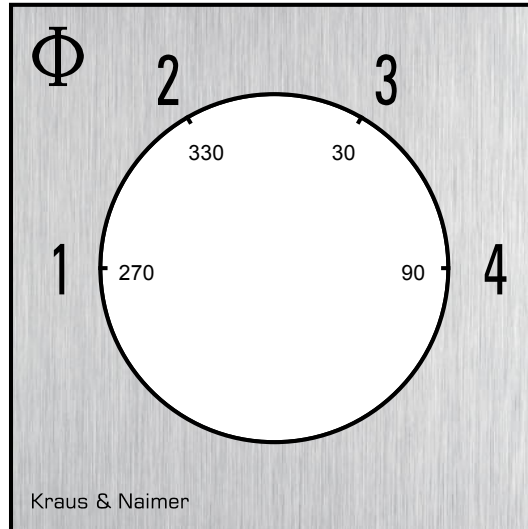

HANDLES

Designation: S0C.G251
Handle colour: "1" black

