

Lötfreie Stiftkabelschuhe ohne Isolation

DIN 46230, ausgenommen*

Embout de câble à sertir sans isolation

DIN 46230, excepté*

Uninsulated solderless pin terminals

DIN 46230, except*

Werkstoff:
E-CU sn = Elektrolytkupfer verzinkt

Matière:
E-CU sn = cuivre électrolytique étamé

Material:
E-CU sn = tin-plated electrolytic copper

Temperaturbeständigkeit:
bis +125°C

Résistant à une température:
jusqu'à +125°C

Temperature range:
up to +125°C

Bestellbeispiel:
Exemple de commande:
Example of order:
3739

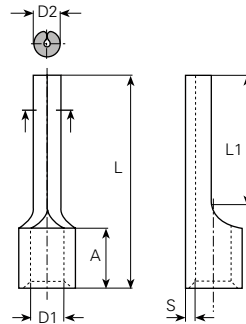

UL-No. E235797

mm ² (AWG)	Artikel-Nr. Numéro d'article Part-No.	DIN 46 230	øD1 mm	øD2 mm	L mm	L1 mm	A mm	S mm	Stand- Packg	Werkzeuge Outils Tools
0.14-0.5 (26-22)	3739	0.5	1	1.4	14	8	4	0.5	1000	3975D
0.5-1 (22-18)	3740	*	1.7	1.9	15	8	5	0.8	1000	3975D / 3980N 3984E
	3740K	*	1.6	1.9	12	5	5	0.8	1000	
	3740L	1	1.6	1.9	17	10	5	0.8	1000	
1.5-2.5 (16-14)	3741	2.5	2.3	1.9	17	10	5	0.8	1000	3980N / 3982E 3994F
	3741K	*	2.3	1.9	12	5	5	0.8	1000	
	3741L	*	2.3	1.9	22	15	5	0.8	1000	
4-6 (12-10)	3742	6	3.4	2.8	20	10	6	1	500	3980N / 3982E 3994F

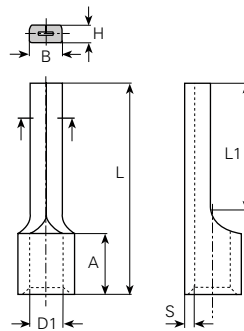

UL-No. E235797

mm ² (AWG)	Artikel-Nr. Numéro d'article Part-No.	DIN 46 230	øD1 mm	B mm	H mm	L mm	L1 mm	A mm	S mm	Stand- Packg	Werkzeuge Outils Tools
10 (8)	3743	10	4.5	4.3	2.4	22	12	8	1.1	500	3980N / 3981AN
16 (6)	3744	16	5.8	5.5	2.6	26	13	10	1.2	200	
25 (4)	37441	*	6.7	6.8	2.6	33.5	15	13.5	1.2	200	3981AN / 3982CN 3982E / 3982G
35 (2)	37442	*	8.9	8	3	39	20	14	1.4	100	
50 (1/0)	37443	*	9.8	9.5	3.6	45	20	19	1.8	100	
70 (2/0)	37444	*	11.2	11	4	55	23	24	2	50	3981AN / 3982CN 3982G

Lötfreie Stiftkabelschuhe mit Polyamid-Isolation

DIN 46231, ausgenommen*

Werkstoff:

E-CU sn = Elektrolytkupfer verzinkt

Temperaturbeständigkeit:

-55°C bis +105°C

Bestellbeispiel:

Exemple de commande:

Example of order:

3745B

Embouts de câble à sertir avec isolation en polyamide

DIN 46231, excepté*

Matière:

E-CU sn = cuivre électrolytique étamé

Résistant à une température de:

-55°C à +105°C

Solderless pin terminals with polyamid insulation

DIN 46231, except*

Material:



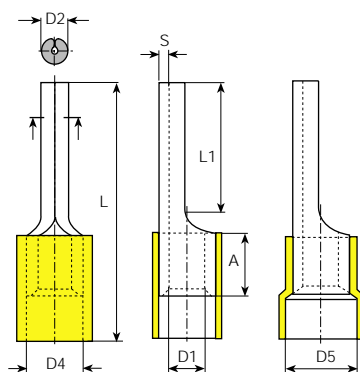

E-CU sn = tin-plated electrolytic copper

Temperature range:

-55°C up to +105°C



UL- No. E235797

mm ² (AWG)	Farben Couleurs Colours	Artikel-Nr. Numéro d'article Part-No.	DIN 46 231	øD1 mm	øD2 mm	øD4 mm	øD5 mm	L mm	L1 mm	A mm	S mm	Stand- Packg.	Werkzeuge Outils Tools
0.14-0.5 (26-22)		3745B	*	1	1.4	2	-	18	8	4	0.5	1000	3974N 3984L
0.5-1 (22-18)		3745	*	1.7	1.9	3.2	-	20	8	5	0.8	500	3974N 3984C 3984O 3986N 3986S
		3745W	*	1.6	1.9	-	4	20	8	5	0.8	500	
		3745K	*	1.6	1.9	3.2	-	17	5	5	0.8	500	
		3745L	*	1.7	1.9	-	4	23	10	5	0.8	500	
		3745LW	*	1.6	1.9	-	4	22	10	5	0.8	500	
1.5-2.5 (16-14)		3746	2.5	2.3	1.9	4.5	-	23	10	5	0.8	500	3974N 3984D 3986N 3986S
		3746W	*	2.3	1.9	-	5.1	23	10	5	0.8	500	
		3746K	*	2.3	1.9	4.5	-	18	5	5	0.8	500	
		3746L	*	2.3	1.9	4.5	-	27	15	5	0.8	500	
4-6 (12-10)		3747	6	3.4	2.8	6.4	-	27	14	6	1	500	3974N 3984D 3986N 3986S

Lötfreie Stiftkabelschuhe mit PVC-Isolation

DIN 46231, ausgenommen*

Werkstoff:

E-CU sn = Elektrolytkupfer verzinkt

Temperaturbeständigkeit:

-10°C bis +75°C

Bestellbeispiel:

Exemple de commande:

Example of order:

3747B

Embout de câble à sertir avec isolation en PVC

DIN 46231, excepté*

Matière:

E-CU sn = cuivre électrolytique étamé

Résistant à une température de:

-10°C à +75°C

Solderless pin terminals with PVC insulation

DIN 46231, except*

Material:



E-CU sn = tin-plated electrolytic copper

Temperature range:

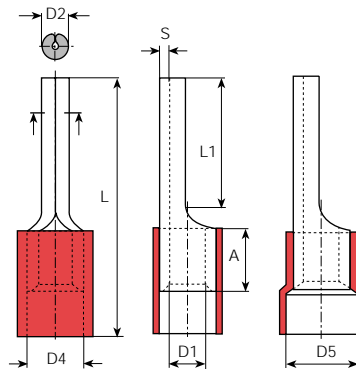
-10°C up to +75°C



UL- No. E235797

mm ² (AWG)	Farben Couleurs Colours	Artikel-Nr. Numéro d'article Part-No.	DIN 46 231	øD1 mm	øD2 mm	øD4 mm	øD5 mm	L mm	L1 mm	A mm	S mm	Stand- Packg	Werkzeuge Outils Tools
0.5-1 (22-18)		3747B	*	1.7	1.9	4	-	18.8	8	5	0.8	500	3974N 3984C 3984O 3986N 3986S
		3747K	*	1.6	1.9	3.2	-	17	5	5	0.8	500	
		3747L	1	1.7	1.9	4	-	22	10	5	0.8	500	
		3747LW	*	1.6	1.9	4	-	22	10	5	0.8	500	
1.5-2.5 (16-14)		3748	2.5	2.3	1.9	4.5	-	23	10	5	0.8	500	3986N 3986S
		3748W	*	2.3	1.9	-	5.1	23	10	5	0.8	500	
		3748K	*	2.3	1.9	4.3	-	18	5	5	0.8	500	
		3748L	*	2.3	1.9	4.3	-	28	15	5	0.8	500	
4-6 (12-10)		3749	6	3.4	2.7	6.3	-	27	10	6	1	500	3974N 3984D 3986N 3986S

Lötfreie Stiftkabelschuhe
mit PVC-Isolation
in Bandform

Embout de câble à sertir
avec isolation
en PVC, en bande

Solderless pin terminals
with PVC insulation
in chain form

Werkstoff:
E-CU sn = Elektrolytkupfer verzinkt

Temperaturbeständigkeit:
-10°C bis +75°C

Bestellbeispiel:
Exemple de commande:
Example of order:

37472

Matière:
E-CU sn = cuivre électrolytique étamé



Résistant à une température de:
-10°C à +75°C

Material:
E-CU sn = tin-plated electrolytic copper

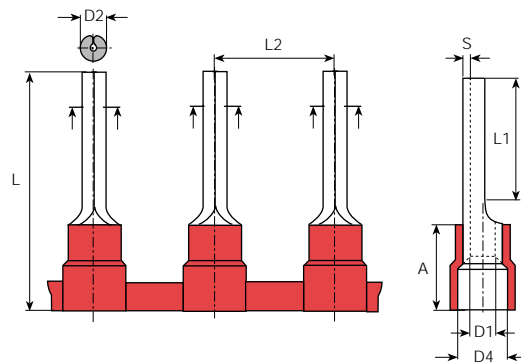
Temperature range:
-10°C up to +75°C



UL-No. E44245

mm ² (AWG)	Farben Couleurs Colours	Artikel-Nr. Numéro d'article Part-No.	øD1 mm	øD2 mm	øD4 mm	L mm	L1 mm	L2 mm	A mm	S mm	Rolle Bobine Reel	
0.5-1 (22-18)		37472	1.7	1.9	4.1	23	11	16	10	0.8	à 1'500	Crimp-Press und Applikator auf Anfrage
1.5-2.5 (16-14)		37482	2.3	1.9	4.5	23	11	16	10	0.8	à 1'500	Presse automatique et outils sur demande
4-6 (12-10)		37492	3.4	2.7	6.8	26.5	11	16	14	1	à 1'000	Automatic applicator and dies on request