

LM6152,LM6154

*LM6152/LM6154 Dual and Quad 75 MHz GBW Rail-to-Rail I/O Operational
Amplifiers*



Literature Number: SNOS752C

LM6152/LM6154

Dual and Quad 75 MHz GBW Rail-to-Rail I/O Operational Amplifiers

General Description

Using patented circuit topologies, the LM6152/LM6154 provides new levels of speed vs. power performance in applications where low voltage supplies or power limitations previously made compromise necessary. With only 1.4 mA/amplifier supply current, the 75 MHz gain bandwidth of this device supports new portable applications where higher power devices unacceptably drain battery life. The slew rate of the devices increases with increasing input differential voltage, thus allowing the device to handle capacitive loads while maintaining large signal amplitude.

The LM6152/LM6154 can be driven by voltages that exceed both power supply rails, thus eliminating concerns about exceeding the common-mode voltage range. The rail-to-rail output swing capability provides the maximum possible dynamic range at the output. This is particularly important when operating on low supply voltages.

Operating on supplies from 2.7V to over 24V, the LM6152/LM6154 is excellent for a very wide range of applications, from battery operated systems with large bandwidth requirements to high speed instrumentation.

Features

At $V_S = 5V$, typical unless noted.

- Greater than rail-to-rail input CMVR $-0.25V$ to $5.25V$
- Rail-to-rail output swing $0.01V$ to $4.99V$
- Wide gain-bandwidth $75\text{ MHz @ }100\text{ kHz}$
- Slew rate
 - Small signal $5\text{ V}/\mu\text{s}$
 - Large signal $45\text{ V}/\mu\text{s}$
- Low supply current 1.4 mA/amplifier
- Wide supply range $2.7V$ to $24V$
- Fast settling time of $1.1\ \mu\text{s}$ for $2V$ step (to 0.01%)
- PSRR 91 dB
- CMRR 84 dB

Applications

- Portable high speed instrumentation
- Signal conditioning amplifier/ADC buffers
- Barcode scanners

Connection Diagrams

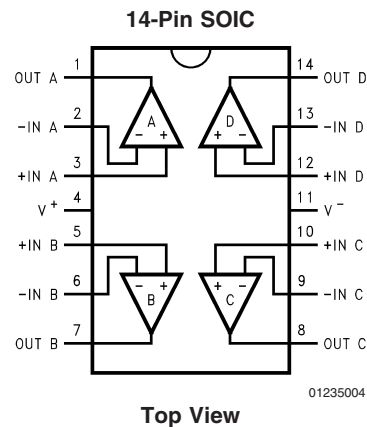
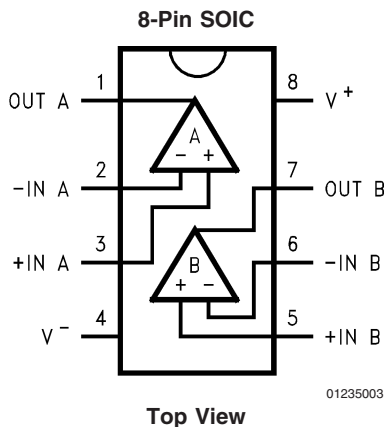

Ordering Information

Package	Part Number	Package Marking	Transport Media	NSC Drawing
8-Pin SOIC	LM6152ACM	LM6152ACM	95 Units/Rails	M08A
	LM6152ACMX		2.5k Units Tape and Reel	
	LM6152BCM	LM6152BCM	95 Units/Rails	
	LM6152BCMX		2.5k Units Tape and Reel	
14-Pin SOIC	LM6154BCM	LM6154BCM	55 Units/Rails	M14A
	LM6154BCMX		2.5k Units Tape and Reel	

Absolute Maximum Ratings (Note 1)

If Military/Aerospace specified devices are required, please contact the National Semiconductor Sales Office/Distributors for availability and specifications.

ESD Tolerance (Note 2)	2500V
Differential Input Voltage	15V
Voltage at Input/Output Pin	(V ⁺) + 0.3V, (V ⁻) -0.3V
Supply Voltage (V ⁺ - V ⁻)	35V
Current at Input Pin	±10 mA
Current at Output Pin (Note 3)	±25 mA
Current at Power Supply Pin	50 mA
Lead Temperature (soldering, 10 sec)	260°C

Storage Temperature Range -65°C to +150°C

Junction Temperature (Note 4) 150°C

Operating Ratings (Note 1)

Supply Voltage	2.7V ≤ V ⁺ ≤ 24V
Junction Temperature Range	0°C ≤ T _J ≤ +70°C
LM6152, LM6154	
Thermal Resistance (θ _{JA})	
8-pin SOIC	193°C/W
14-pin SOIC	126°C/W

5.0V DC Electrical Characteristics

Unless otherwise specified, all limits are guaranteed for T_J = 25°C, V⁺ = 5.0V, V⁻ = 0V, V_{CM} = V_O = V⁺/2 and R_L > 1 MΩ to V⁺/2. **Boldface** limits apply at the temperature extremes.

Symbol	Parameter	Conditions	Typ (Note 5)	LM6154AC	LM6154BC	Units
				LM6152AC Limit (Note 6)	LM6152BC Limit (Note 6)	
V _{OS}	Input Offset Voltage		0.54	2 4	5 7	mV max
TCV _{OS}	Input Offset Voltage Average Drift		10			μV/°C
I _B	Input Bias Current	0V ≤ V _{CM} ≤ 5V	500 750	980 1500	980 1500	nA max
I _{OS}	Input Offset Current		32 40	100 160	100 160	nA max
R _{IN}	Input Resistance, CM	0V ≤ V _{CM} ≤ 4V	30			MΩ
CMRR	Common Mode Rejection Ratio	0V ≤ V _{CM} ≤ 4V	94	70	70	dB
		0V ≤ V _{CM} ≤ 5V	84	60	60	min
PSRR	Power Supply Rejection Ratio	5V ≤ V ⁺ ≤ 24V	91	80	80	dB min
V _{CM}	Input Common-Mode Voltage Range	Low	-0.25	0	0	V
		High	5.25	5.0	5.0	V
A _V	Large Signal Voltage Gain	R _L = 10 kΩ	214	50	50	V/mV min
V _O	Output Swing	R _L = 100 kΩ	0.006	0.02 0.03	0.02 0.03	V max
			4.992	4.97 4.96	4.97 4.96	V min
		R _L = 2 kΩ	0.04	0.10 0.12	0.10 0.12	V max
			4.89	4.80 4.70	4.80 4.70	V min
I _{SC}	Output Short Circuit Current	Sourcing	6.2	3 2.5	3 2.5	mA min
				27 17	27 17	mA max
		Sinking	16.9	7 5	7 5	mA min
				40	40	mA max

5.0V DC Electrical Characteristics (Continued)

Unless otherwise specified, all limits are guaranteed for $T_J = 25^\circ\text{C}$, $V^+ = 5.0\text{V}$, $V^- = 0\text{V}$, $V_{\text{CM}} = V_O = V^+/2$ and $R_L > 1\text{ M}\Omega$ to $V^+/2$. **Boldface** limits apply at the temperature extremes.

Symbol	Parameter	Conditions	Typ (Note 5)	LM6154AC LM6152AC Limit (Note 6)	LM6154BC LM6152BC Limit (Note 6)	Units
I_S	Supply Current	Per Amplifier	1.4	2 2.25	2 2.25	mA max

5.0V AC Electrical Characteristics

Unless otherwise specified, all limits guaranteed for $T_J = 25^\circ\text{C}$, $V^+ = 5.0\text{V}$, $V^- = 0\text{V}$, $V_{\text{CM}} = V_O = V^+/2$ and $R_L > 1\text{ M}\Omega$ to $V^+/2$. **Boldface** limits apply at the temperature extremes.

Symbol	Parameter	Conditions	Typ (Note 5)	LM6154AC LM6152AC Limit (Note 6)	LM6154BC LM6152BC Limit (Note 6)	Units
SR	Slew Rate	$\pm 4\text{V Step @ } V_S = \pm 6\text{V}$, $R_S < 1\text{ k}\Omega$	30	24 15	24 15	V/ μs min
GBW	Gain-Bandwidth Product	$f = 100\text{ kHz}$	75			MHz
	Amp-to-Amp Isolation	$R_L = 10\text{ k}\Omega$	125			dB
e_n	Input-Referred Voltage Noise	$f = 1\text{ kHz}$	9			nV/ $\sqrt{\text{Hz}}$
i_n	Input-Referred Current Noise	$f = 1\text{ kHz}$	0.34			pA/ $\sqrt{\text{Hz}}$
T.H.D	Total Harmonic Distortion	$f = 100\text{ kHz}$, $R_L = 10\text{ k}\Omega$ $A_V = -1$, $V_O = 2.5\text{ V}_{\text{PP}}$	-65			dBc
t_s	Settling Time	2V Step to 0.01%	1.1			μs

2.7V DC Electrical Characteristics

Unless otherwise specified, all limits are guaranteed for $T_J = 25^\circ\text{C}$, $V^+ = 2.7\text{V}$, $V^- = 0\text{V}$, $V_{\text{CM}} = V_O = V^+/2$ and $R_L > 1\text{ M}\Omega$ to $V^+/2$. **Boldface** limits apply at the temperature extremes.

Symbol	Parameter	Conditions	Typ (Note 5)	LM6154AC LM6152AC Limit (Note 6)	LM6154BC LM6152BC Limit (Note 6)	Units
V_{OS}	Input Offset Voltage		0.8	2 5	5 8	mV max
TCV_{OS}	Input Offset Voltage Average Drift		10			$\mu\text{V}/^\circ\text{C}$
I_B	Input Bias Current		500			nA
I_{OS}	Input Offset Current		50			nA
R_{IN}	Input Resistance, CM	$0\text{V} \leq V_{\text{CM}} \leq 1.8\text{V}$	30			$\text{M}\Omega$
CMRR	Common Mode Rejection Ratio	$0\text{V} \leq V_{\text{CM}} \leq 1.8\text{V}$	88			dB
		$0\text{V} \leq V_{\text{CM}} \leq 2.7\text{V}$	78			
PSRR	Power Supply Rejection Ratio	$3\text{V} \leq V^+ \leq 5\text{V}$	69			dB
V_{CM}	Input Common-Mode Voltage Range	Low	-0.25	0	0	V
		High	2.95	2.7	2.7	V
A_V	Large Signal Voltage Gain	$R_L = 10\text{ k}\Omega$	5.5			V/mV
V_O	Output Swing	$R_L = 10\text{ k}\Omega$	0.032	0.07 0.11	0.07 0.11	V max
			2.68	2.64 2.62	2.64 2.62	V min
I_S	Supply Current	Per Amplifier	1.35			mA

2.7V AC Electrical Characteristics

Unless otherwise specified, all limits are guaranteed for $T_J = 25^\circ\text{C}$, $V^+ = 2.7\text{V}$, $V^- = 0\text{V}$, $V_{\text{CM}} = V_O = V^+/2$ and $R_L > 1\text{M}\Omega$ to $V^+/2$. **Boldface** limits apply at the temperature extremes.

Symbol	Parameter	Conditions	Typ (Note 5)	LM6154AC LM6152AC Limit (Note 6)	LM6154BC LM6152BC Limit (Note 6)	Units
GBW	Gain-Bandwidth Product	$f = 100\text{ kHz}$	80			MHz

24V DC Electrical Characteristics

Unless otherwise specified, all limits are guaranteed for $T_J = 25^\circ\text{C}$, $V^+ = 24\text{V}$, $V^- = 0\text{V}$, $V_{\text{CM}} = V_O = V^+/2$ and $R_L > 1\text{M}\Omega$ to $V^+/2$. **Boldface** limits apply at the temperature extremes.

Symbol	Parameter	Conditions	Typ (Note 5)	LM6154AC LM6152AC Limit (Note 6)	LM6154BC LM6152BC Limit (Note 6)	Units
V_{OS}	Input Offset Voltage		0.3	2 4	7 9	mV max
TCV_{OS}	Input Offset Voltage Average Drift		10			$\mu\text{V}/^\circ\text{C}$
I_{B}	Input Bias Current		500			nA
I_{OS}	Input Offset Current		32			nA
R_{IN}	Input Resistance, CM	$0\text{V} \leq V_{\text{CM}} \leq 23\text{V}$	60			Meg Ω
CMRR	Common Mode Rejection Ratio	$0\text{V} \leq V_{\text{CM}} \leq 23\text{V}$	94			dB
		$0\text{V} \leq V_{\text{CM}} \leq 24\text{V}$	84			
PSRR	Power Supply Rejection Ratio	$0\text{V} \leq V_{\text{CM}} \leq 24\text{V}$	95			dB
V_{CM}	Input Common-Mode Voltage Range	Low	-0.25	0	0	V
		High	24.25	24	24	V
A_V	Large Signal Voltage Gain	$R_L = 10\text{ k}\Omega$	55			V/mV
V_O	Output Swing	$R_L = 10\text{ k}\Omega$	0.044	0.075 0.090	0.075 0.090	V max
			23.91	23.8 23.7	23.8 23.7	V min
I_{S}	Supply Current	Per Amplifier	1.6	2.25 2.50	2.25 2.50	mA max

24V AC Electrical Characteristics

Unless otherwise specified, all limits are guaranteed for $T_J = 25^\circ\text{C}$, $V^+ = 24\text{V}$, $V^- = 0\text{V}$, $V_{\text{CM}} = V_O = V^+/2$ and $R_L > 1\text{M}\Omega$ to $V^+/2$. **Boldface** limits apply at the temperature extremes.

Symbol	Parameter	Conditions	Typ (Note 5)	LM6154AC LM6152AC Limit (Note 6)	LM6154BC LM6152BC Limit (Note 6)	Units
GBW	Gain-Bandwidth Product	$f = 100\text{ kHz}$	80			MHz

Note 1: Absolute Maximum Ratings indicate limits beyond which damage to the device may occur. Operating Ratings indicate conditions for which the device is intended to be functional, but specific performance is not guaranteed. For guaranteed specifications and the test conditions, see the Electrical Characteristics.

Note 2: Human body model is 1.5 k Ω in series with 100 pF.

Note 3: Applies to both single-supply and split-supply operation. Continuous short circuit operation at elevated ambient temperature can result in exceeding the maximum allowed junction temperature of 150°C.

Note 4: The maximum power dissipation is a function of $T_{\text{J(MAX)}}$, θ_{JA} , and T_{A} . The maximum allowable power dissipation at any ambient temperature is $P_{\text{D}} = (T_{\text{J(MAX)}} - T_{\text{A}}) / \theta_{\text{JA}}$. All numbers apply for packages soldered directly into a PC board.

Note 5: Typical Values represent the most likely parametric norm.

Note 6: All limits are guaranteed by testing or statistical analysis.

Typical Performance Characteristics

Supply Current vs. Supply Voltage

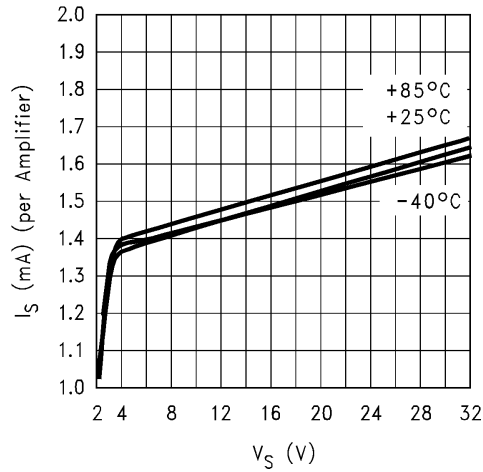

Offset Voltage vs. Supply voltage

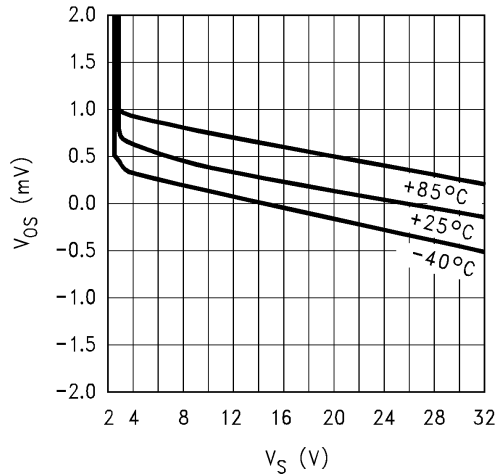

Bias Current vs. Supply voltage

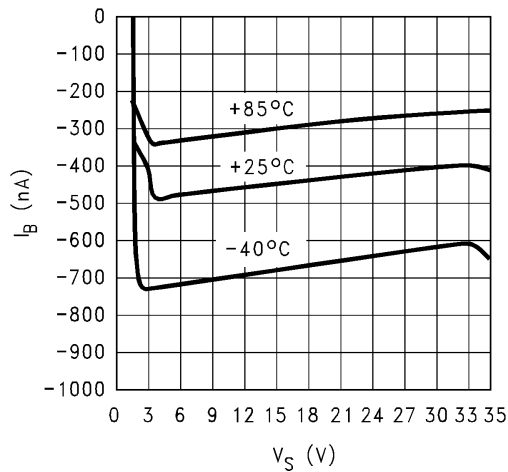

Bias Current vs. V_CM

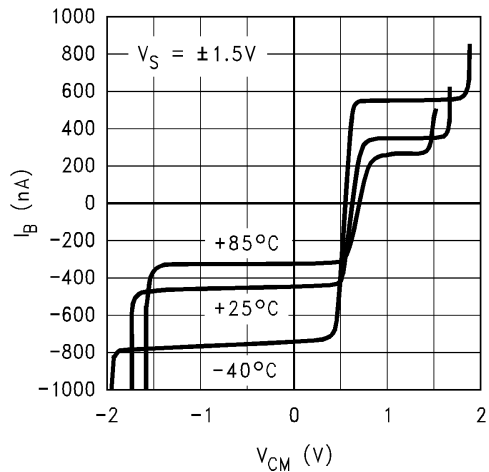

Bias Current vs. V_CM

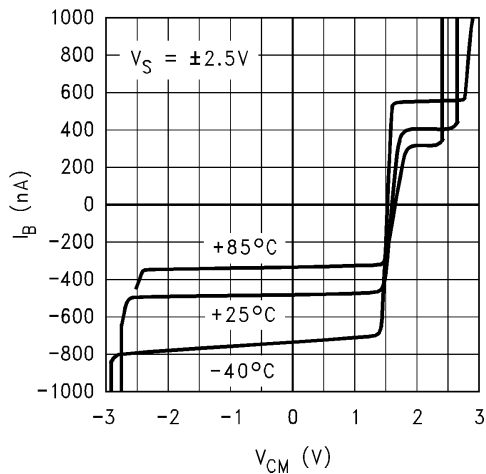

Bias Current vs. V_CM

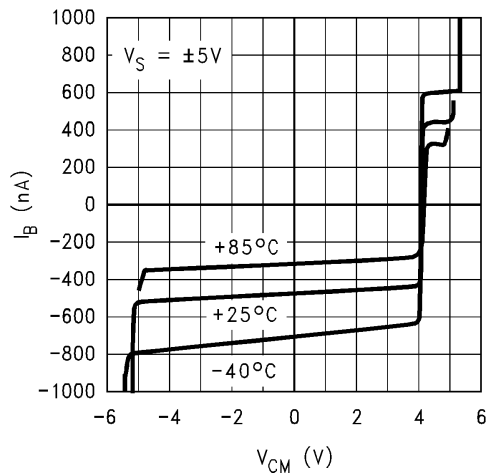

Typical Performance Characteristics (Continued)

Output Voltage vs. Source Current

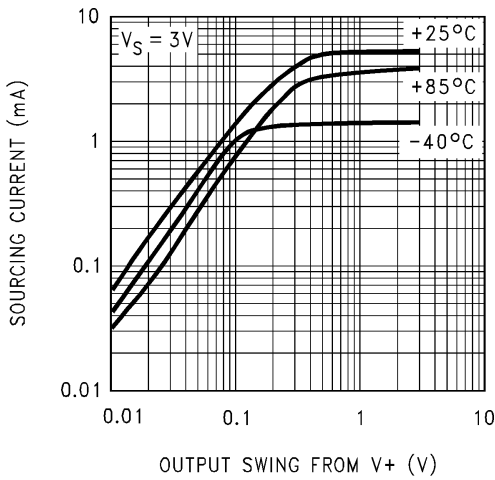

Output Voltage vs. Source Current

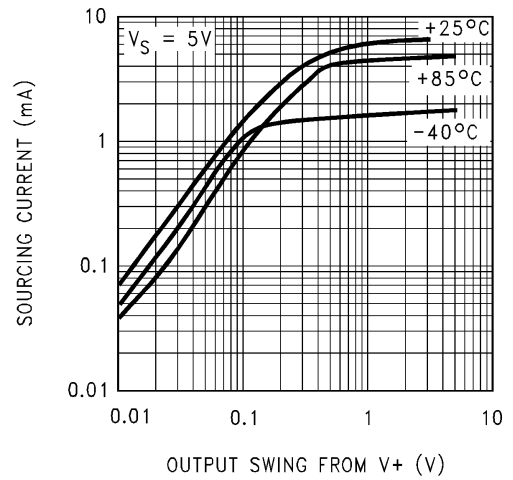

Output Voltage vs. Source Current

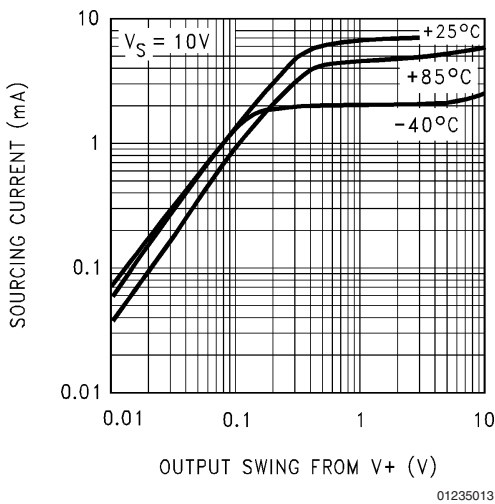

Output Voltage vs. Sink Current

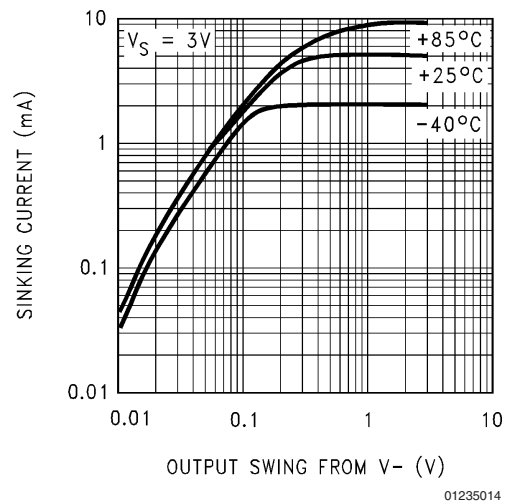

Output Voltage vs. Sink Current

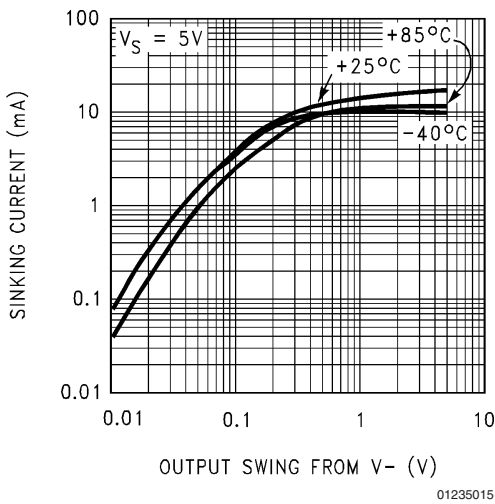

Output Voltage vs. Sink Current

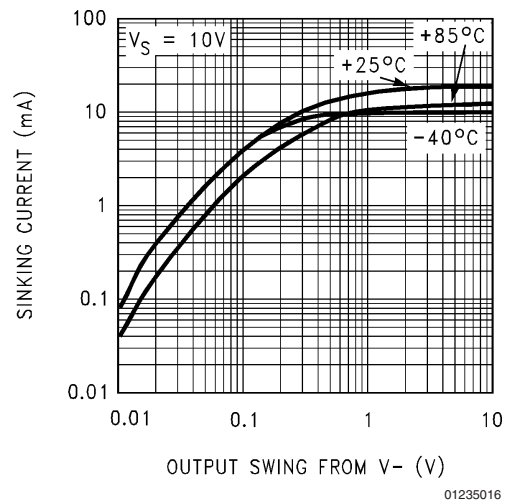

Typical Performance Characteristics (Continued)

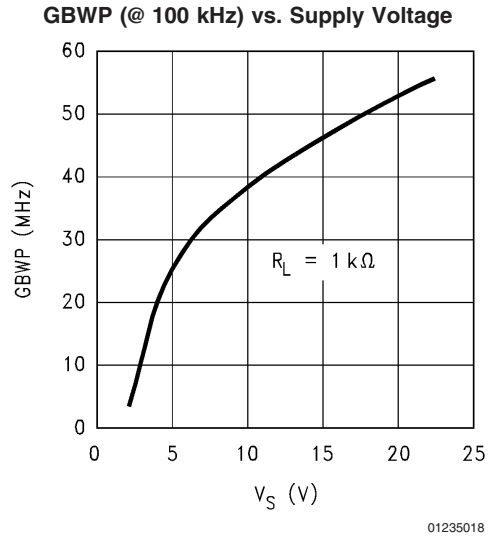
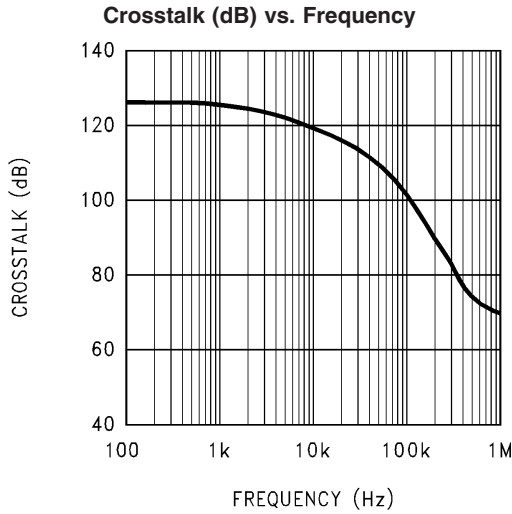

Unity Gain Frequency vs. Supply Voltage for Various Loads

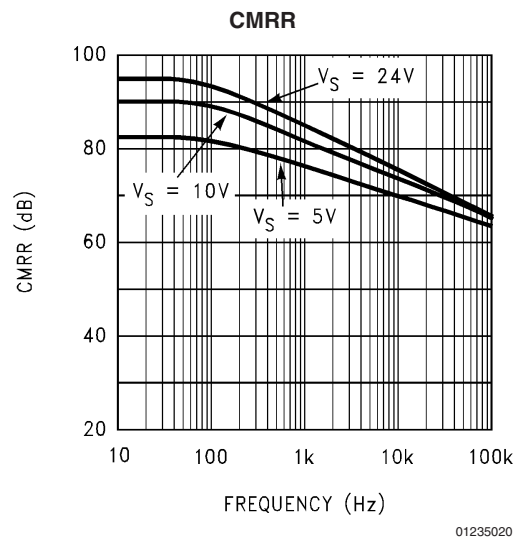
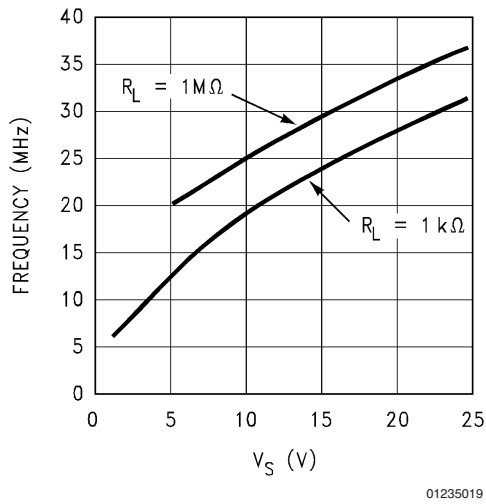

Voltage Swing vs. Frequency ($C_L = 100\text{ pF}$)

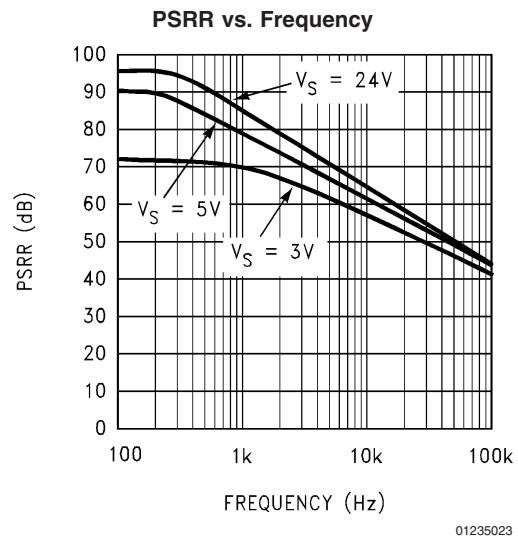
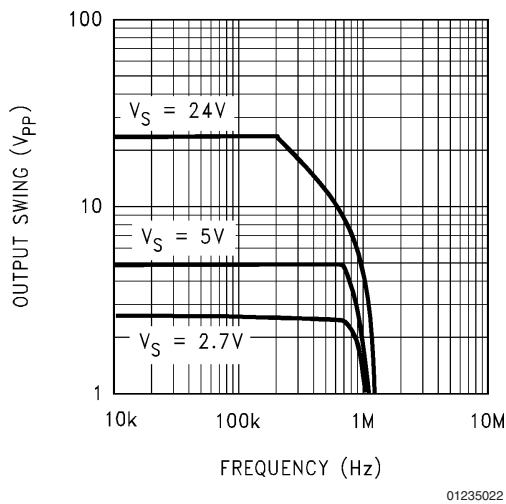

Typical Performance Characteristics (Continued)

Open Loop Gain/Phase
($V_S = 5V$)

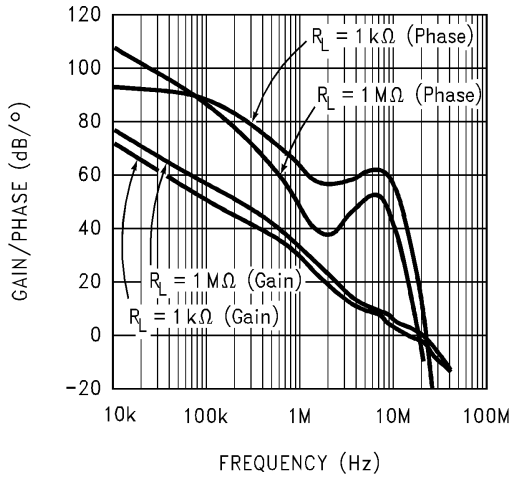

Open Loop Gain/Phase
($V_S = 10V$)

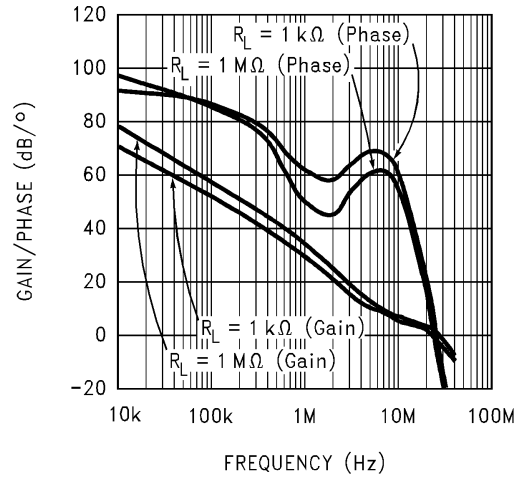

Open Loop Gain/Phase
($V_S = 24V$)

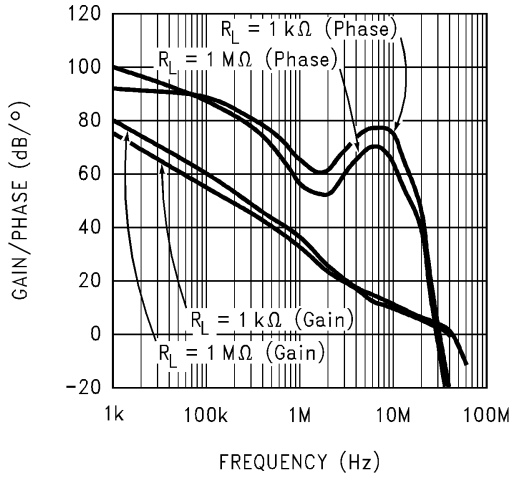

Noise Voltage vs. Frequency

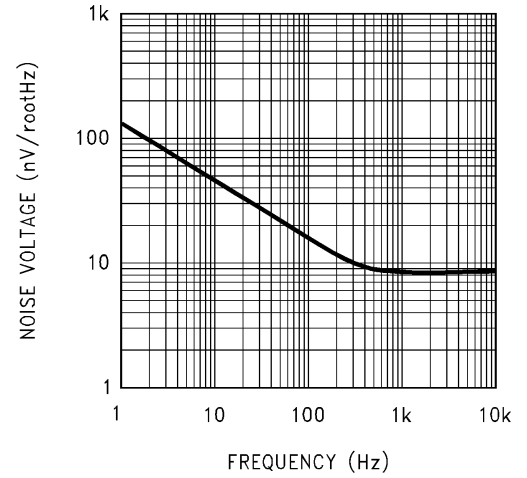

Noise Current vs. Frequency

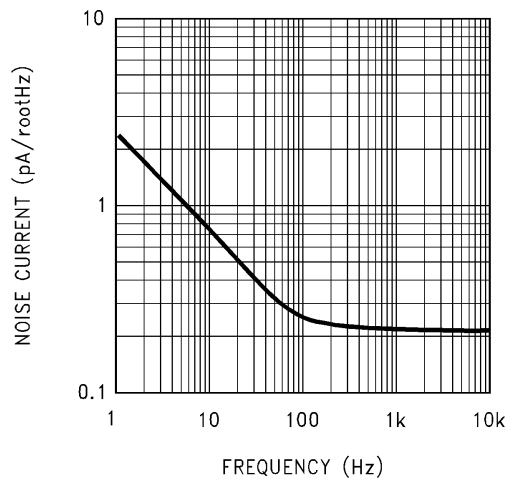

Voltage Error vs. Settle Time

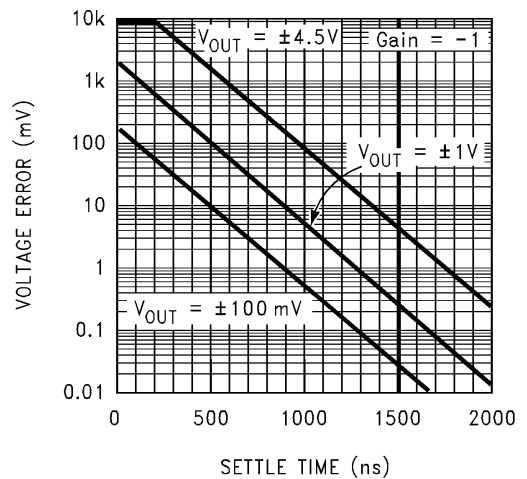

Typical Performance Characteristics (Continued)

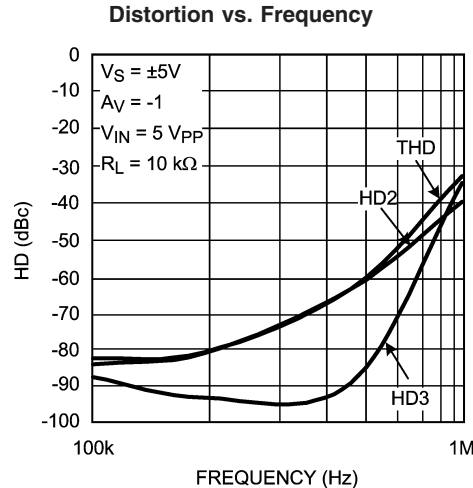

Application Information

The LM6152/LM6154 is ideally suited for operation with about 10 kΩ (Feedback Resistor, R_F) between the output and the negative input terminal.

With R_F set to this value, for most applications requiring a close loop gain of 10 or less, an additional small compensation capacitor (C_F) (see Figure 1) is recommended across R_F in order to achieve a reasonable overshoot (10%) at the output by compensating for stray capacitance across the inputs.

The optimum value for C_F can best be established experimentally with a trimmer cap in place since its value is dependant on the supply voltage, output driving load, and the operating gain. Below, some typical values used in an inverting configuration and driving a 10 kΩ load have been tabulated for reference:

TABLE 1. Typical BW (-3 dB) at Various Supply Voltage and Gains

V_S Volts	Gain	C_F pF	BW (-3 dB) MHz
3	-1	5.6	4
	-10	6.8	1.97
	-100	None	0.797
24	-1	2.2	6.6
	-10	4.7	2.2
	-100	None	0.962

In the non-inverting configuration, the LM6152/LM6154 can be used for closed loop gains of +2 and above. In this case, also, the compensation capacitor (C_F) is recommended across R_F (= 10 kΩ) for gains of 10 or less.

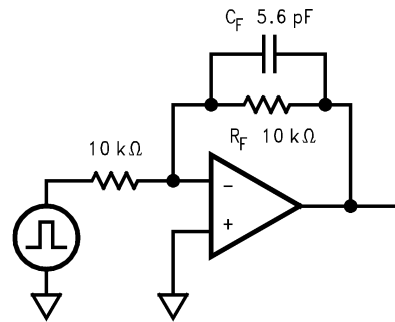

FIGURE 1. Typical Inverting Gain Circuit $A_V = -1$

Because of the unique structure of this amplifier, when used at low closed loop gains, the realizable BW will be much less than the GBW product would suggest.

The LM6152/LM6154 brings a new level of ease of use to op amp system design.

The greater than rail-to-rail input voltage range eliminates concern over exceeding the common-mode voltage range. The rail-to-rail output swing provides the maximum possible dynamic range at the output. This is particularly important when operating on low supply voltages.

The high gain-bandwidth with low supply current opens new battery powered applications where higher power consumption previously reduced battery life to unacceptable levels.

The ability to drive large capacitive loads without oscillating functional removes this common problem.

To take advantage of these features, some ideas should be kept in mind.

The LM6152/LM6154, capacitive loads do not lead to oscillations, in all but the most extreme conditions, but they will result in reduced bandwidth. They also cause increased settling time.

Application Information (Continued)

Unlike most bipolar op amps, the unique phase reversal prevention/speed-up circuit in the input stage, caused the slew rate to be very much a function of the input pulse amplitude. This results in a 10 to 1 increase in slew rate when the differential input signal increases. Large fast pulses will raise the slew-rate to more than 30 V/ μ s.

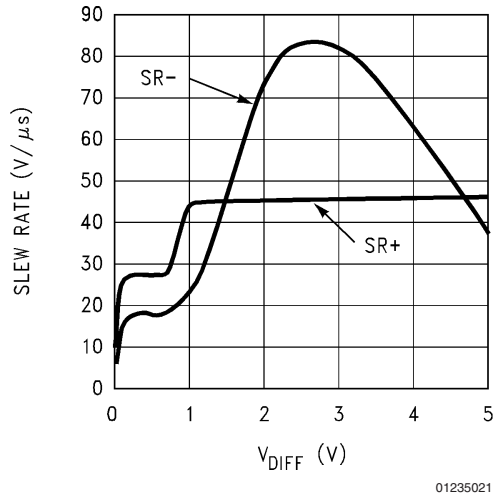

FIGURE 2. Slew Rate vs. V_{DIFF}

The speed-up action adds stability to the system when driving large capacitive loads.

A conventional op amp exhibits a fixed maximum slew-rate even though the differential input voltage rises due to the lagging output voltage. In the LM6152/LM6154, increasing lag causes the differential input voltage to increase but as it does, the increased slew-rate keeps the output following the input much better. This effectively reduces phase lag. As a result, the LM6152/LM6154 can drive capacitive loads as large as 470 pF at gain of 2 and above, and not oscillate.

Capacitive loads decrease the phase margin of all op amps. This can lead to overshoot, ringing and oscillation. This is caused by the output resistance of the amplifier and the load capacitance forming an R-C phase shift network. The LM6152/6154 senses this phase shift and partly compensates for this effect.

Physical Dimensions inches (millimeters) unless otherwise noted

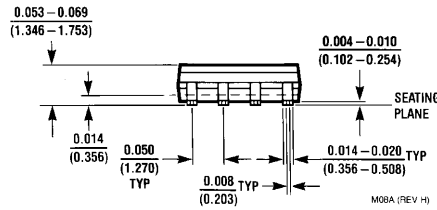
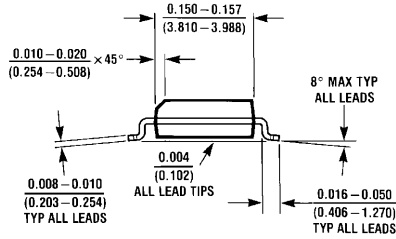
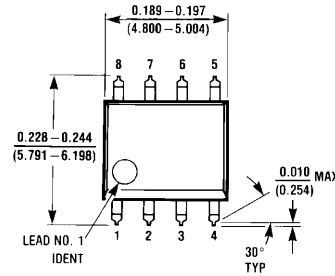

8-Pin SOIC
NSC Package Number M08A

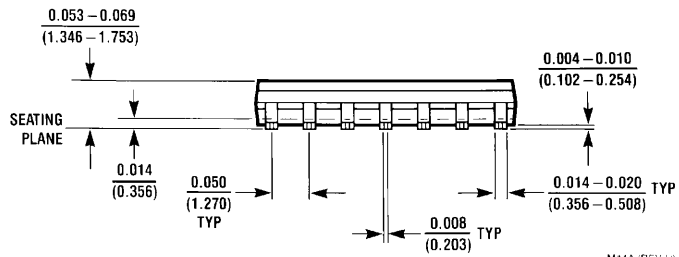
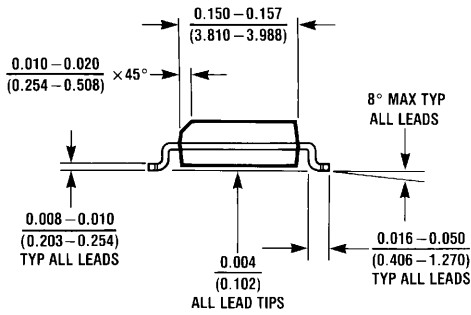
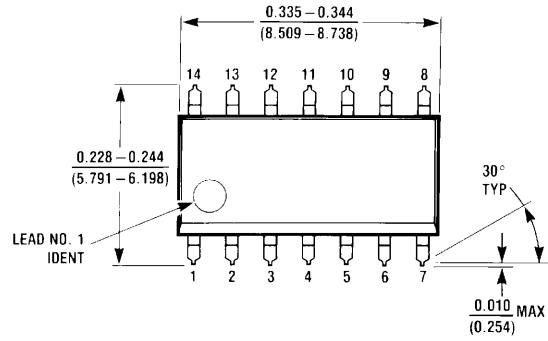

14-Pin SOIC
NSC Package Number M14A

Notes

National does not assume any responsibility for use of any circuitry described, no circuit patent licenses are implied and National reserves the right at any time without notice to change said circuitry and specifications.

For the most current product information visit us at www.national.com.

LIFE SUPPORT POLICY

NATIONAL'S PRODUCTS ARE NOT AUTHORIZED FOR USE AS CRITICAL COMPONENTS IN LIFE SUPPORT DEVICES OR SYSTEMS WITHOUT THE EXPRESS WRITTEN APPROVAL OF THE PRESIDENT AND GENERAL COUNSEL OF NATIONAL SEMICONDUCTOR CORPORATION. As used herein:

- | | |
|--|---|
| <p>1. Life support devices or systems are devices or systems which, (a) are intended for surgical implant into the body, or (b) support or sustain life, and whose failure to perform when properly used in accordance with instructions for use provided in the labeling, can be reasonably expected to result in a significant injury to the user.</p> | <p>2. A critical component is any component of a life support device or system whose failure to perform can be reasonably expected to cause the failure of the life support device or system, or to affect its safety or effectiveness.</p> |
|--|---|

BANNED SUBSTANCE COMPLIANCE

National Semiconductor manufactures products and uses packing materials that meet the provisions of the Customer Products Stewardship Specification (CSP-9-111C2) and the Banned Substances and Materials of Interest Specification (CSP-9-111S2) and contain no "Banned Substances" as defined in CSP-9-111S2.

Leadfree products are RoHS compliant.



National Semiconductor
Americas Customer
Support Center
Email: new.feedback@nsc.com
Tel: 1-800-272-9959

National Semiconductor
Europe Customer Support Center
Fax: +49 (0) 180-530 85 86
Email: europe.support@nsc.com
Deutsch Tel: +49 (0) 69 9508 6208
English Tel: +44 (0) 870 24 0 2171
Français Tel: +33 (0) 1 41 91 8790

National Semiconductor
Asia Pacific Customer
Support Center
Email: ap.support@nsc.com

National Semiconductor
Japan Customer Support Center
Fax: 81-3-5639-7507
Email: jpn.feedback@nsc.com
Tel: 81-3-5639-7560

IMPORTANT NOTICE

Texas Instruments Incorporated and its subsidiaries (TI) reserve the right to make corrections, modifications, enhancements, improvements, and other changes to its products and services at any time and to discontinue any product or service without notice. Customers should obtain the latest relevant information before placing orders and should verify that such information is current and complete. All products are sold subject to TI's terms and conditions of sale supplied at the time of order acknowledgment.

TI warrants performance of its hardware products to the specifications applicable at the time of sale in accordance with TI's standard warranty. Testing and other quality control techniques are used to the extent TI deems necessary to support this warranty. Except where mandated by government requirements, testing of all parameters of each product is not necessarily performed.

TI assumes no liability for applications assistance or customer product design. Customers are responsible for their products and applications using TI components. To minimize the risks associated with customer products and applications, customers should provide adequate design and operating safeguards.

TI does not warrant or represent that any license, either express or implied, is granted under any TI patent right, copyright, mask work right, or other TI intellectual property right relating to any combination, machine, or process in which TI products or services are used. Information published by TI regarding third-party products or services does not constitute a license from TI to use such products or services or a warranty or endorsement thereof. Use of such information may require a license from a third party under the patents or other intellectual property of the third party, or a license from TI under the patents or other intellectual property of TI.

Reproduction of TI information in TI data books or data sheets is permissible only if reproduction is without alteration and is accompanied by all associated warranties, conditions, limitations, and notices. Reproduction of this information with alteration is an unfair and deceptive business practice. TI is not responsible or liable for such altered documentation. Information of third parties may be subject to additional restrictions.

Resale of TI products or services with statements different from or beyond the parameters stated by TI for that product or service voids all express and any implied warranties for the associated TI product or service and is an unfair and deceptive business practice. TI is not responsible or liable for any such statements.

TI products are not authorized for use in safety-critical applications (such as life support) where a failure of the TI product would reasonably be expected to cause severe personal injury or death, unless officers of the parties have executed an agreement specifically governing such use. Buyers represent that they have all necessary expertise in the safety and regulatory ramifications of their applications, and acknowledge and agree that they are solely responsible for all legal, regulatory and safety-related requirements concerning their products and any use of TI products in such safety-critical applications, notwithstanding any applications-related information or support that may be provided by TI. Further, Buyers must fully indemnify TI and its representatives against any damages arising out of the use of TI products in such safety-critical applications.

TI products are neither designed nor intended for use in military/aerospace applications or environments unless the TI products are specifically designated by TI as military-grade or "enhanced plastic." Only products designated by TI as military-grade meet military specifications. Buyers acknowledge and agree that any such use of TI products which TI has not designated as military-grade is solely at the Buyer's risk, and that they are solely responsible for compliance with all legal and regulatory requirements in connection with such use.

TI products are neither designed nor intended for use in automotive applications or environments unless the specific TI products are designated by TI as compliant with ISO/TS 16949 requirements. Buyers acknowledge and agree that, if they use any non-designated products in automotive applications, TI will not be responsible for any failure to meet such requirements.

Following are URLs where you can obtain information on other Texas Instruments products and application solutions:

Products

Audio	www.ti.com/audio
Amplifiers	amplifier.ti.com
Data Converters	dataconverter.ti.com
DLP® Products	www.dlp.com
DSP	dsp.ti.com
Clocks and Timers	www.ti.com/clocks
Interface	interface.ti.com
Logic	logic.ti.com
Power Mgmt	power.ti.com
Microcontrollers	microcontroller.ti.com
RFID	www.ti-rfid.com
OMAP Mobile Processors	www.ti.com/omap
Wireless Connectivity	www.ti.com/wirelessconnectivity

Applications

Communications and Telecom	www.ti.com/communications
Computers and Peripherals	www.ti.com/computers
Consumer Electronics	www.ti.com/consumer-apps
Energy and Lighting	www.ti.com/energy
Industrial	www.ti.com/industrial
Medical	www.ti.com/medical
Security	www.ti.com/security
Space, Avionics and Defense	www.ti.com/space-avionics-defense
Transportation and Automotive	www.ti.com/automotive
Video and Imaging	www.ti.com/video

TI E2E Community Home Page

e2e.ti.com

Mailing Address: Texas Instruments, Post Office Box 655303, Dallas, Texas 75265
Copyright © 2011, Texas Instruments Incorporated