









## Ficha técnica

### Rueda ZV-UT 2-0244

Codigo				Tipo cojinete Eje					
2-0244	200	400	50	—	136x116	110x84/98x66	10	238	-



#### Características

Chapa de acero hasta 4mm de espesor.  
Acabado cincado brillante.  
Soporte embutido con doble hilera de bolas.  
Modelo de uso universal para cargas medias.  
Fabricadas según normas europeas EN 12530/12532.

#### Datos técnicos

**Diámetro:** 200 mm  
**Carga:** 400 kg  
**Tipo de cojinete:** Cojinete Liso  
**Ancho de Banda de rodadura:** 50 mm  
**Medidas de placa superior:** 136x116 mm  
**Distancia entre agujeros:** 110x84/98x66 mm  
**Diámetro agujero sujeción platina:** 10 mm  
**Altura total:** 238 mm

#### Archivos CAD

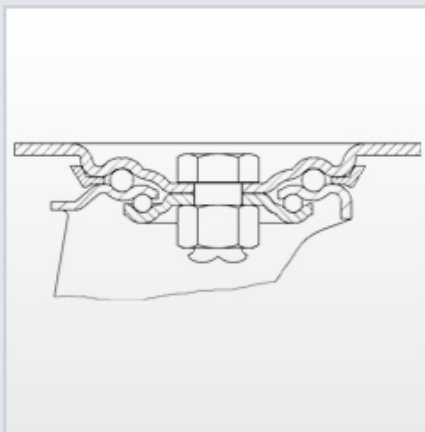

#### Rueda

UT (Poliamix)  
Rueda de poliamix blanco  
**Rango de temperatura:** -20° ÷ +60°

#### Productos relacionados

