

E11048

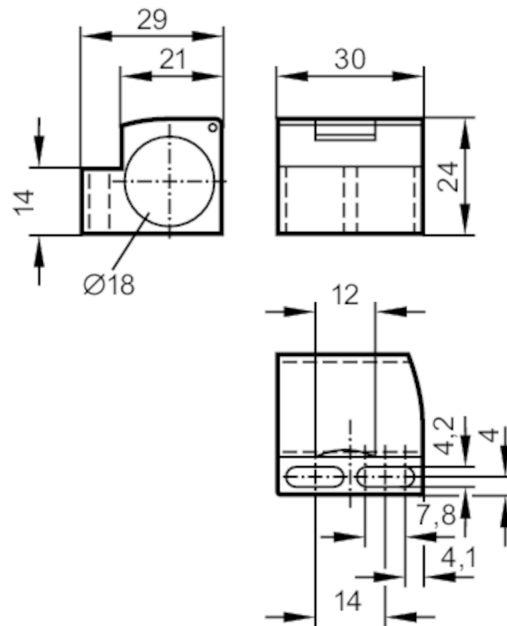

Mounting clamp for position sensors

MOUNTING CLAMP M18



Application

Design with end stop

Operating conditions

Ambient temperature [°C] -25...85

Mechanical data

Weight [g] 11.5
Dimensions [mm] 24 x 30 x 29
Inside diameter [mm] 18
Materials PC

Remarks

Pack quantity 1 pcs.