

M12 FEMALE 90°

PUR 12x0.25 GRAY, 5m

M12

Female 90°

12-pole

Art.-No. 7005 - M12 Lite - (plastic hexagonal screw) on request

Plastic housings with good resistance against chemicals and oils. The resistance to aggressive media should be individually tested for your application. Further details on request. Further cable lengths on request.

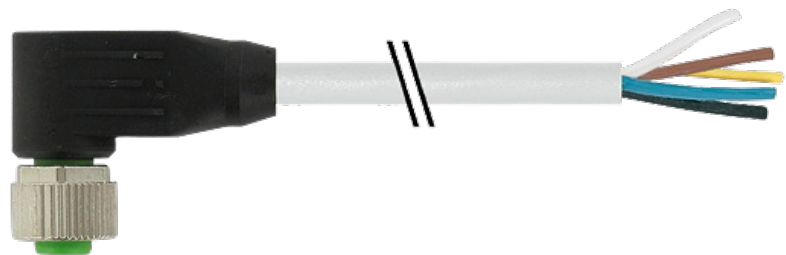
[Link to Product](#)**Illustration**

| | |
|----|-----------|
| 1 | brown |
| 2 | blue |
| 3 | white |
| 4 | green |
| 5 | pink |
| 6 | yellow |
| 7 | black |
| 8 | gray |
| 9 | red |
| 10 | violet |
| 11 | gray/pink |
| 12 | red/blue |

Female

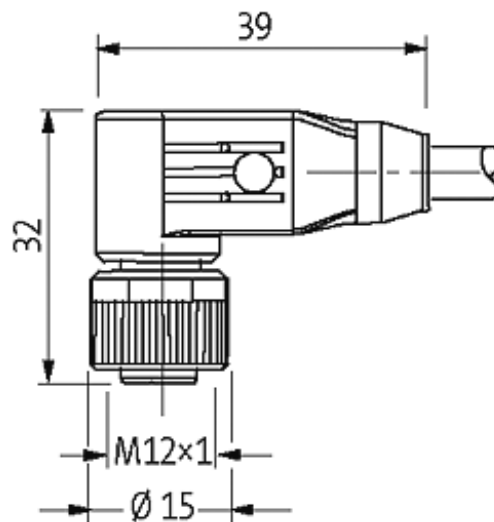
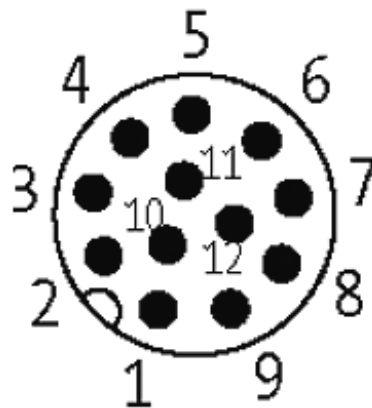

Product may differ from Image

Approvals



Form

19061

Technical Data

| | |
|-------------------------------|---|
| Operating voltage | max. 30 V AC/DC |
| Operating current per contact | max. 1.5 A |
| Locking of ports | Screw thread M12 × 1 mm (recommended torque 0.6 Nm) self-securing |
| Protection | IP67 inserted and tightened (EN 60529) |

Cables

| | |
|--------------|-----|
| Cable number | 301 |
|--------------|-----|

| | |
|-----------------------------|---|
| No./diameter of wires | 12 × 0.25 mm ² |
| Wire isolation | PP (br, bl, wh, gn, pk, ye, bk, gr, rd, vi, grpk, rdbl) |
| C-track properties | 3 Mio. |
| Jacket Color | gray |
| Shore hardness outer jacket | 85 ± 5A |
| Material (jacket) | PUR (UL/CSA) |
| Outer diameter | approx. 6.9 mm |
| Bend radius (fixed) | 10 × outer Ø |
| Bend radius (moving) | 15 × outer Ø |
| Temperature range (fixed) | -40...+80 °C |
| Temperature range (mobile) | -20...+80 °C |

General data

| | |
|-------------------|--|
| Temperature range | -25...+85 °C, depending on cable quality |
|-------------------|--|

Commercial data

| | |
|------------------------|----------|
| country of origin | DE |
| customs tariff number | 85444290 |
| minimum order quantity | 1 |