

M12 male 90°/M12 female 90° shielded B-cod.Profibus

PUR 1x2xAWG24 shielded vt UL/CSA+dragchain 15m

PROFIBUS, B-coded

Male 90° to female 90°

M12 - M12

2-pole, shielded

Plastic housings with good resistance against chemicals and oils. The resistance to aggressive media should be individually tested for your application. Further details on request. Further cable lengths on request.

[Link to Product](#)

Illustration

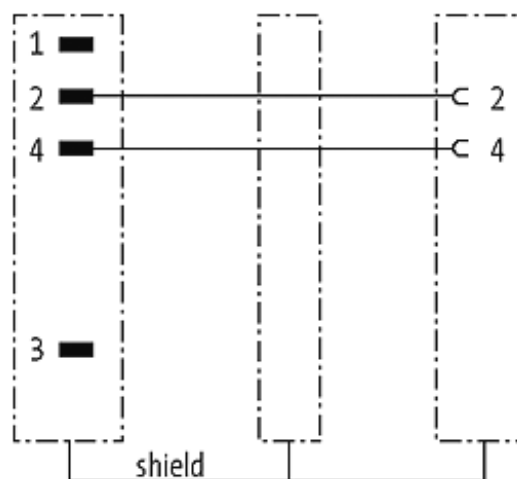

Male

Female



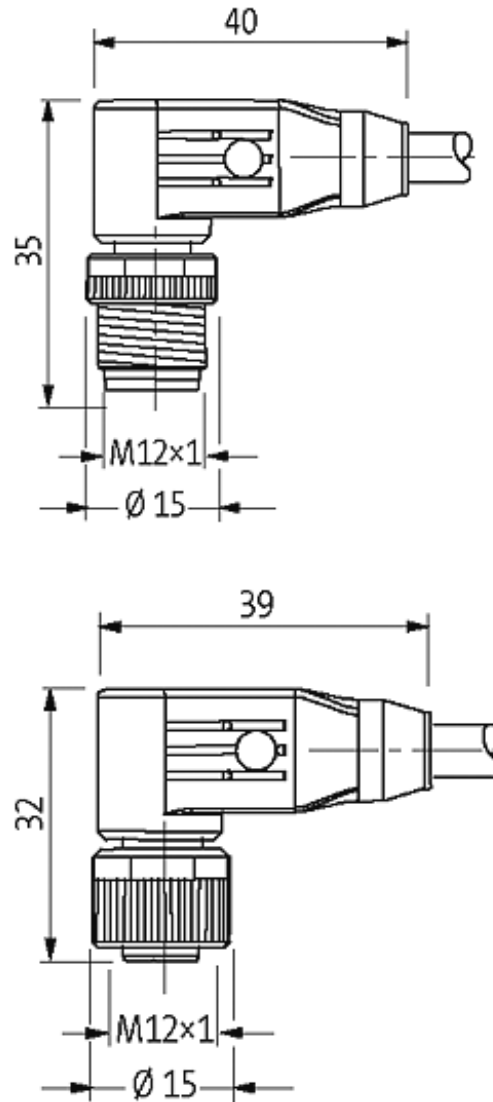

Product may differ from Image

Approvals



More Info



Form

44021

Technical Data

Operating voltage	max. 60 V AC/DC
-------------------	-----------------

Operating current per contact	max. 4 A
Locking of ports	Screw thread M12 × 1 mm (recommended torque 0.6 Nm) self-securing
Protection	IP67 inserted and tightened (EN 60529)

Cables

Cable number	841
No./diameter of wires	1 × 2 × Ø 0.64 mm, (violet)
Wire isolation	PE (rd, gn)
C-track properties	5 Mio.
Jacket Color	violet
Shore hardness outer jacket	87 ± 3A
Material (jacket)	PUR (UL/CSA)
Outer diameter	approx. 7.7 mm
Bend radius (fixed)	7.5 × outer Ø
Bend radius (moving)	12 × outer Ø
Temperature range (fixed)	-40...+80 °C
Temperature range (mobile)	-20...+60 °C
Shielded	yes

Commercial data

country of origin	DE
customs tariff number	85444290
minimum order quantity	1