

Actuator/Sensor cable, PUR
Connection cable
PKG3M-5/TXY

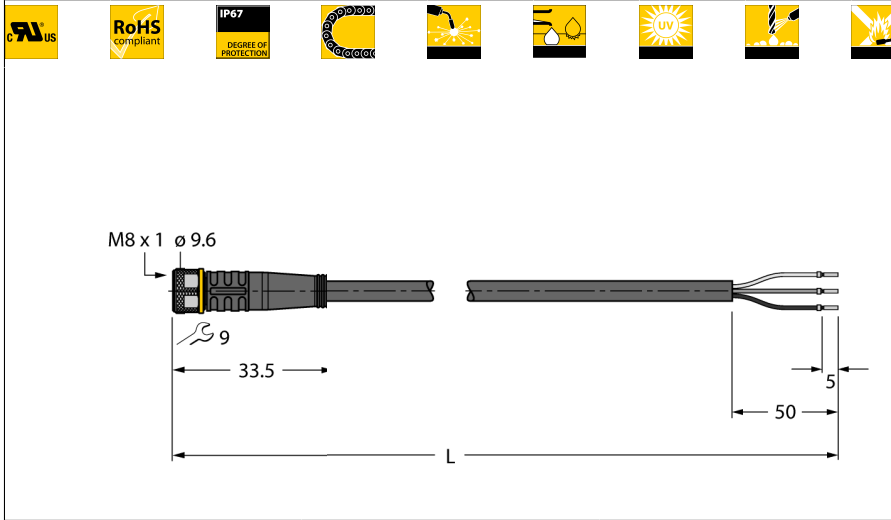

- Female M8, straight, 3-pin
- Sheath material: PUR
- Sheath color: yellow
- Qualified for drag chain use
- Resistant to weld splatter
- Resistant to chemicals, UV radiation and oils
- Flame retardant
- Free from halogen, silicone, PVC and LABS
- Particularly resistant to abrasion
- Approval: cULus
- RoHS conform
- Protection class IP67
- Cable length: 5.0 m

Type designation	PKG3M-5/TXY
Ident no.	6630062

Connector A side	Female connector, M8 (← 1, Straight
Number of pins	3
Contacts	Brass, CuZn, Gold-plated
Contact carriers	Plastic, TPU, Black
Grip	Plastic, TPU, Black
Coupling nut/screw	Brass, CuZn, Nickel-plated
Seal	Plastic, FPM/FKM
Protection class	IP67, A + B side screwed together
Mechanical lifespan	> 100 Mating cycles
Pollution degree	3
Tightening torque	0.5 ... 0.6 Nm (observe max. torque of counter piece!)

General data	
Cable diameter	4.3 ± 0.20mm
Cable length	5 m
Cable quality	PUR
Cable color	Yellow
Core insulation	PP
Core colors	BN, BU, BK
Core cross-section	3x0.34mm ²
Arrangement of strands	42x0.1 mm

Electrical features at +20 °C	
Current	4 A
Rated voltage	60 V
Insulation resistance	> 30.5 MΩ/km
Test voltage	2000 V
Forward resistance	max. 57 Ω/km

Cable Cross-section

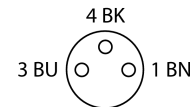
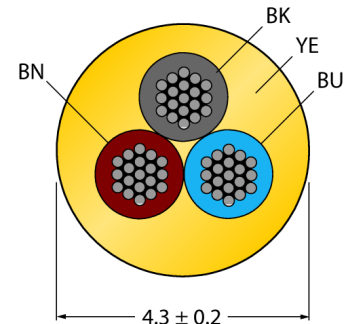

General information

Drawing shows design status including hexagon coupling nut (Start of production CW21/2016).

Circuit Diagram

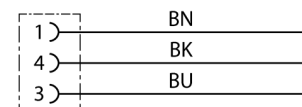

Actuator/Sensor cable, PUR
Connection cable
PKG3M-5/TXY

TURCK

Industrial
Automation

Mechanical and chemical properties

Max. tensile strength (static)	≤ 50 N/mm ²
Max. tensile strength (dynamic)	≤ 20 N/mm ²
Bending cycles	> 5 mil.
Bending radius (stationary laying)	> 5 x Ø
Bending radius (flexible use)	> 10 x Ø
Admissible acceleration	max. 5 m/s ²
Admissible travel path, horizontal	5 m (at 5 m/s ²)
Admissible travel path, vertical	2 m (at 5 m/s ²)
Admissible traversing speed	3.3 m/s
Torsional stress	± 180 °/m
Ambient temperature	
Stationary	-50...+80°C
In motion	-25...+80°C
Drag chain operation	-25...+60°C

Actuator/Sensor cable, PUR
Connection cable
PKG3M-5/TXY

Accessories

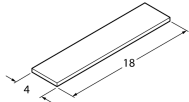
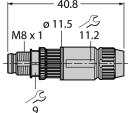
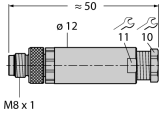
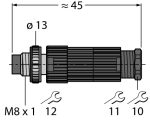
Type code	Ident no.	Description	
Torque-Wrench-Set-AS	6936170	Torque wrench set; handles with adjustable torque 0.4-1.0 Nm, torque wrench for M8 (SW9), fork wrench for M12 (SW 14)	
BLANK-LABEL-FOR-CORDSETS-TEL-TXL	6936206	Label for TEL and TXL cables, length: 18 mm, height: 4 mm, material: polycarbonate (PC), color: white, halogen-free and flame-retardant	
HAS5131-0	6905402	Field-wireable male connector, M8 (1, straight, 3-pin, insulation piercing connection, cable feedthrough 2.5 to 5.1 mm, core cross-section/terminal capacity 0.14 to 0.34 mm ² , plastic housing, metal nut	
BS5133-0	6901012	Field-wireable male connector, M8 (1, straight, 3-pin, screw terminal connection, cable feedthrough 3.5 to 5.0 mm, core cross-section/terminal capacity 0.14 to 0.50 mm ² , plastic housing, metal nut	
HS5131-0	6902710	Field-wireable male connector, M8 (1, straight, 3-pin, pressfit technology, cable feedthrough 4.0 to 5.0 mm, core cross-section/terminal capacity 0.14 to 0.34 mm ² , plastic housing, metal nut	

Actuator/Sensor cable, PUR
Connection cable
PKG3M-5/TXY

TURCK

Industrial
Automation

Accessories

Type code	Ident no.	Description	
HS5231-0	6902810	Field-wireable male connector, M8 (↙) 1, angled, 3-pin, pressfit technology, cable feedthrough 4.0 to 5.0 mm, core cross-section/terminal capacity 0.14 to 0.34 mm ² , plastic housing, metal nut	