

Commando

Industrial Plugs and Sockets

1:20



Commando® Industrial Plugs and Sockets

Description

A comprehensive range of industrial plugs, connectors, socket outlets and appliance inlets. The products are designed to meet IEC.309 and BS EN.60309-2 offering a choice of IP44 splashproof or an IP67 watertight rating. The Commando range offers remarkable impact strength by way of its PBT

housing. Outstanding temperature performance and good resistance to most chemicals make it ideal for the most arduous applications. Contact pins and sleeves are of solid brass with stainless steel springs to keep contacts free of dirt and to ensure constant contact pressure.

Features

- Robust construction throughout.
- Convex cable seal and protector.
- Rounded end-packing won't snag or collect debris when dragged.
- Ergonomic design. Rounded corners with no sharp edges.
- Easier and better grip for connection and disconnection
- Calibrated sleeves fit with stainless steel springs to maintain even contact pressure.
- Self cleaning contact surfaces.
- Top grade brass in all contact parts means no galvanic corrosion.
- Cover opens with a flick of your thumb or finger even with thick gloves on.



Commando

Industrial Plugs and Sockets

2:20

PLUGS 16 AND 32 AMP

IP 44 SPLASHPROOF

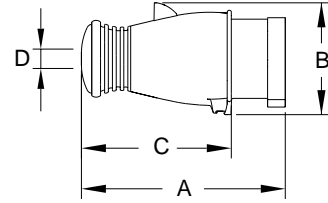

Amps	Pin. Configuration	100-130V	200-250V	380-415V	440-460V	480-500V	Cable Diameter D min max	Terminal Capacity sq. mm*	Dimensions in mm		
		50-60Hz List No	50-60Hz List No	50-60Hz List No	50-60Hz List No	50-60Hz List No			A	B	C
16	2P+E	K9000 YEL 4	K9001 BLU 6	K9002 RED 9			8.2 13	1 - 2.5	115	63	78
16	3P+E	K9005 YEL 4	K9006 BLU 9	K9007 RED 6	K9008 RED 11	K9009 BLK 7	8.9 17	1 - 2.5	140	72	103
16	3P+N+E	K9013 YEL 4	K9014 BLU 9	K9015 RED 6	K9016 RED 11		10.1 17	1 - 2.5	140	76	103
32	2P+E	K9032 YEL 4	K9033 BLU 6				11.7 21.5	2.5 - 6	156	83	110
32	3P+E	K9035 YEL 4	K9036 BLU 9	K9037 RED 6	K9038 RED 11	K9039 BLK 7	11.7 21.5	2.5 - 6	156	83	110
32	3P+N+E	K9043 YEL 4	K9044 BLU 9	K9045 RED 6	K9046 RED 11		14.2 21.5	2.5 - 6	156	88	110

Amps	Pin. Configuration	>50V	>50V	IS TRAN	>50-250V	Cable Diameter D min max	*Terminal Capacity sq. mm	Dimensions in mm		
		100-300Hz List No	300-500Hz List No	50-60Hz List No	d.c. List No			A	B	C
16	2P+E			K9004 GRY 12	K9003 GRY 3	8.2 13	1 - 2.5	115	63	78
16	3P+E	K9010 GRN 10	K9011 GRN 2			8.9 17	1 - 2.5	140	72	103
16	3P+N+E		K9017 GRN 2			10.1 17	1 - 2.5	140	76	103
32	3P+N+E		K9047 GRN 2			11.7 21.5	2.5 - 6	156	83	110

🔴 Earth Hour Position

*flexible conductors

PLUGS 63 AMP

FITTED WITH CABLE ENTRY GLAND THREAD SIZE M48 X 2

IP 44 SPLASHPROOF

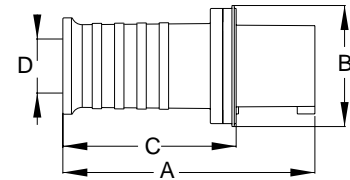

Amps	Pin. Configuration	200-250V	380-415V	Cable Diameter D		Terminal Capacity sq. mm*	Dimensions in mm		
		50-60Hz List No	50-60Hz List No	min	max		A	B	C
63	2P+E	K9063 BLU 6		16.5	35	4 - 16	215	103	148
63	3P+E	K9065 BLU 9	K9066 RED 6	16.5	35	4 - 16	215	103	148
63	3P+N+E		K9071 RED 6	16.5	35	4 - 16	215	103	148

🔴 Earth Hour Position

*flexible conductors

PLUGS ELV

IP 44 SPLASHPROOF

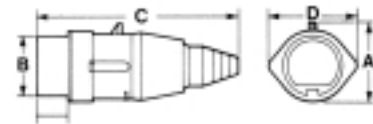

Amps	Pin. Configuration	25V	50V	25 & 50V	Cable Diameter min max	Terminal Capacity sq. mm*	Dimensions in mm			
		50-60Hz List No	50-60Hz List No	50-60Hz List No			A	B	C	D
16	2P	K9018 VLT	K9020 WHI 12	K9022 WHI 10	7 24	4 - 10 and 2 x 6mm ²	55	42	145	62
16	3P	K9019 VLT	K9021 WHI 12		7 24	4 - 10 and 2 x 6mm ²	55	42	145	62

🔴 Minor Key Hour Position

*flexible conductors



Commando

Industrial Plugs and Sockets

3:20

PLUGS 16 AND 32 AMP

IP 67 WATERTIGHT

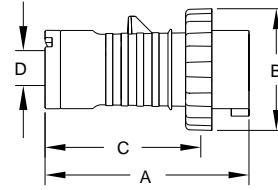

Amps	Pin. Configuration	100-130V 50-60Hz		200-250V 50-60Hz		380-415V 50-60Hz		Cable Diameter D		Terminal Capacity sq. mm*	Dimensions in mm		
		List No	Earth Hour Position	List No	Earth Hour Position	List No	Earth Hour Position	min	max		A	B	C
16	2P+E	K9023 YEL 4	Earth Hour Position	K9024 BLU 6	Earth Hour Position			8.2	22	1 - 2.5	128	71	94
16	3P+E					K9025 RED 6	Earth Hour Position	8.9	22	1 - 2.5	144	79	111
16	3P+N+E					K9026 RED 6	Earth Hour Position	10.1	30	1 - 2.5	146	87	112
32	2P+E	K9053 YEL 4	Earth Hour Position	K9054 BLU 6	Earth Hour Position			11.7	30	2.5 - 6	147	94	105
32	3P+E					K9055 RED 6	Earth Hour Position	11.7	30	2.5 - 6	147	94	105
32	3P+N+E					K9056 RED 6	Earth Hour Position	14.2	37	2.5 - 6	161	101	119

Earth Hour Position

*flexible conductors

PLUGS 63 AND 125 AMP

IP 67 WATERTIGHT

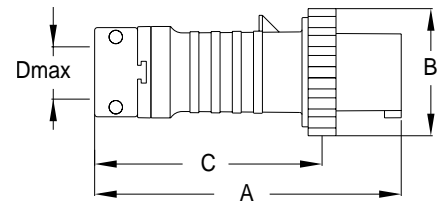

Amps	Pin. Configuration	100-130V 50-60Hz		200-250V 50-60Hz		380-415V 50-60Hz		440-460V 50-60Hz		480-500V 50-60Hz		Cable Diameter		Terminal Capacity sq. mm*	Dimensions in mm			
		List No	Earth Hour Position	List No	Earth Hour Position	List No	Earth Hour Position	List No	Earth Hour Position	List No	Earth Hour Position	min	max		A	B	C	D max
63	2P+E	K9294 YEL 4	Earth Hour Position	K9298 BLU 6	Earth Hour Position							14	30	4 - 16	275	114	213	41
63	3P+E					K9282 RED 6	Earth Hour Position	K9283 RED 11	Earth Hour Position	K9284 BLK 7	Earth Hour Position	16.5	30	4 - 16	275	114	213	41
63	3P+N+E					K9292 RED 6	Earth Hour Position	K9293 RED 11	Earth Hour Position			16.5	30	4 - 16	275	114	213	41
125	2P+E			K9099 BLU 6	Earth Hour Position							24	49	16 - 50	313	130	242	48
125	3P+E					K9092 RED 6	Earth Hour Position	K9093 RED 11	Earth Hour Position			24	49	16 - 50	313	130	242	48
125	3P+N+E					K9097 RED 6	Earth Hour Position					24	49	16 - 50	313	130	242	48

Earth Hour Position

*flexible conductors



Commando

Industrial Plugs and Sockets

4:20

CONNECTORS 16 AND 32 AMP

IP 44 SPLASHPROOF

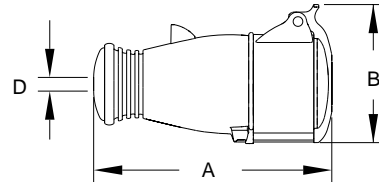

Amps	Pin. Config-uration	100-130V	200-250V	380-415V	440-460V	480-500V	Cable Diameter D min max	Terminal Capacity sq. mm*	Dimensions in mm	
		50-60Hz List No	50-60Hz List No	50-60Hz List No	50-60Hz List No	50-60Hz List No			A	B
16	2P+E	K9100 YEL 4	K9101 BLU 6	K9102 RED 9			8.2 13	1 - 2.5	124	75
16	3P+E	K9105 YEL 4	K9106 BLU 9	K9107 RED 6	K9108 RED 11	K9109 BLK 7	8.9 17	1 - 2.5	150	85
16	3P+N+E	K9113 YEL 4	K9114 BLU 9	K9115 RED 6	K9116 RED 11		10.1 17	1 - 2.5	152	89
32	2P+E	K9132 YEL 4	K9133 BLU 6				11.7 21.5	2.5 - 6	171	93
32	3P+E	K9135 YEL 4	K9136 BLU 9	K9137 RED 6	K9138 RED 11	K9139 BLK 7	11.7 21.5	2.5 - 6	171	93
32	3P+N+E	K9142 YEL 4	K9143 BLU 9	K9144 RED 6	K9145 RED 11		14.2 21.5	2.5 - 6	171	99

Amps	Pin. Config-uration	>50V	>50V	IS TRAN	>50-250V	Cable Diameter D min max	*Terminal Capacity sq. mm	Dimensions in mm	
		100-300Hz List No	300-500Hz List No	50-60Hz List No	d.c. List No			A	B
16	2P+E			K9104 GRY 12	K9103 GRY 3	8.2 13	1 - 2.5	124	75
16	3P+E	K9110 GRN 10	K9111 GRN 2			8.9 17	1 - 2.5	150	85
16	3P+N+E		K9117 GRN 2			10.1 17	1 - 2.5	152	89
32	3P+N+E		K9146 GRN 2			11.7 21.5	2.5 - 6	171	99

🔴 Earth Hour Position

*flexible conductors

CONNECTORS 63 AMP

FITTED WITH CABLE ENTRY GLAND THREAD SIZE M48 X 2

IP 44 SPLASHPROOF

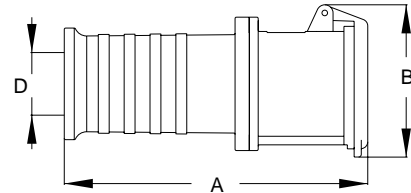

Amps	Pin. Config-uration	200-250V	380-415V	Cable Diameter D		Terminal Capacity sq. mm*	Dimensions in mm	
		50-60Hz List No	50-60Hz List No	min	max		A	B
63	2P+E	K9172 BLU 6		16.5	35	4 - 16	224	112
63	3P+E	K9164 BLU 9	K9165 RED 6	16.5	35	4 - 16	224	112
63	3P+N+E		K9170 RED 6	16.5	35	4 - 16	224	112

🔴 Earth Hour Position

*flexible conductors

CONNECTORS ELV

IP 44 SPLASHPROOF

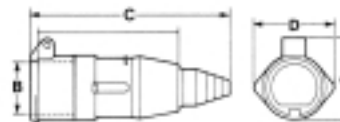

Amps	Pin. Config-uration	25V	50V	25 & 50V	Cable Diameter		Terminal Capacity sq. mm (flexible conductors)	Dimensions in mm			
		50-60Hz List No	50-60Hz List No	50-60Hz List No	min	max		A	B	C	D
16	2P	K9118 VLT	K9120 WHI 12	K9122 WHI 10	7	24	4 - 10 and 2 x 6mm ²	67	43	158	62
16	3P	K9119 VLT	K9121 WHI 12		7	24	4 - 10 and 2 x 6mm ²	67	43	158	62

🔴 Minor Key Hour Position



Commando

Industrial Plugs and Sockets

5:20

CONNECTORS 16 AND 32 AMP

IP 67 WATERTIGHT

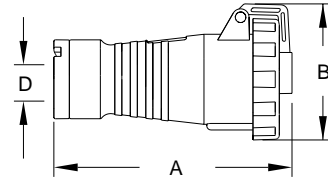

Amps	Pin. Config-uration	100-130V 50-60Hz		200-250V 50-60Hz		380-415V 50-60Hz		Cable Diameter		Terminal Capacity sq. mm*	Dimensions in mm		
		List No	Earth Hour Position	List No	Earth Hour Position	List No	Earth Hour Position	min	max		A	B	D max
16	2P+E	K9123 YEL 4	Earth Hour Position	K9124 BLU 6	Earth Hour Position			8.2	22	1 - 2.5	151	80	13
16	3P+E					K9125 RED 6	Earth Hour Position	8.9	22	1 - 2.5	168	88	17
16	3P+N+E					K9126 RED 6	Earth Hour Position	6.5	30	1 - 2.5	170	97	17
32	2P+E	K9155 YEL 4	Earth Hour Position	K9156 BLU 6	Earth Hour Position			1.7	30	12.5 - 6	177	102	21.5
32	3P+E					K9157 RED 6	Earth Hour Position	11.7	30	2.5 - 6	177	102	21.5
32	3P+N+E					K9158 RED 6	Earth Hour Position	14.2	37	2.5 - 6	182	109	21.5

Earth Hour Position

*flexible conductors

CONNECTORS 63 AND 125 AMP

IP 67 WATERTIGHT

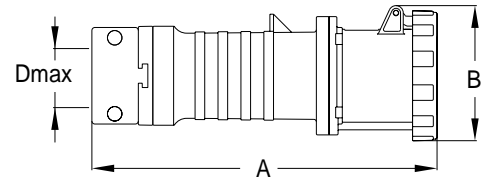

Amps	Pin. Config-uration	100-130V 50-60Hz		200-250V 50-60Hz		380-415V 50-60Hz		440-460V 50-60Hz		480-500V 50-60Hz		Cable Diameter		Terminal Capacity sq. mm*	Dimensions in mm		
		List No	Earth Hour Position	List No	Earth Hour Position	List No	Earth Hour Position	List No	Earth Hour Position	List No	Earth Hour Position	min	max		A	B	D max
63	2P+E	K9855 YEL 4	Earth Hour Position	K9856 BLU 6	Earth Hour Position							14	30	4 - 16	286	111	41
63	3P+E					K9842 RED 6	Earth Hour Position	K9843 RED 11	Earth Hour Position	K9844 BLK 7	Earth Hour Position	16.5	30	4 - 16	286	111	41
63	3P+N+E					K9852 RED 6	Earth Hour Position	K9853 RED 11	Earth Hour Position			16.5	30	4 - 16	286	111	41
125	2P+E			K9189 BLU 6	Earth Hour Position							24	49	16 - 50	325	122	48
125	3P+E					K9182 RED 6	Earth Hour Position	K9183 RED 11	Earth Hour Position			24	49	16 - 50	325	122	48
125	3P+N+E					K9187 RED 6	Earth Hour Position					24	49	16 - 50	325	122	48

Earth Hour Position

*flexible conductors



Commando

Industrial Plugs and Sockets

6:20

**SOCKET OUTLETS
ANGLED SURFACE MOUNTING
16 AND 32 AMP**

TOP CONDUIT OR REAR CABLE ENTRY, COMPLETE WITH BLANKING PLUG

IP 44 SPLASHPROOF

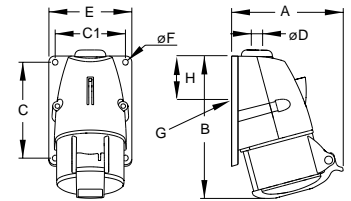

Amps	Pin. Config-uration	100-130V	200-250V	380-415V	440-460V	480-500V	Terminal Capacity sq. mm*	Dimensions in mm							Top Conduit Entry D	Rear entry G
		50-60Hz List No	50-60Hz List No	50-60Hz List No	50-60Hz List No	50-60Hz List No		50-60Hz List No	A	B	C	C1	E	F		
16	2P+E	K9200 YEL 4	K9201 BLU 6	K9202 RED 9			1.5 - 4	91	117	75	54	66	5.5	30	M20	Ø23
16	3P+E	K9205 YEL 4	K9206 BLU 9	K9207 RED 6	K9208 RED 11	K9209 BLK 7	1.5 - 4	100	132	91	67	79	5.5	30	M20	Ø23
16	3P+N+E	K9213 YEL 4	K9214 BLU 9	K9215 RED 6	K9216 RED 11		1.5 - 4	104	134	91	67	79	5.5	30	M20	Ø23
32	2P+E	K9232 YEL 4	K9233 BLU 6				2.5 - 10	118	163	111	72	85	5.5	33	M25	Ø29
32	3P+E	K9235 YEL 4	K9236 BLU 9	K9237 RED 6		K9238 BLK 7	2.5 - 10	116	163	111	72	85	5.5	33	M25	Ø29
32	3P+N+E	K9239 YEL 4	K9240 BLU 9	K9241 RED 6	K9242 RED 11		2.5 - 10	121	164	111	72	85	5.5	33	M25	Ø29

Amps	Pin. Config-uration	>50V	>50V	IS TRAN	>50-250V	Terminal Capacity sq. mm*	Dimensions in mm							Conduit Entry D	Rear Entry G
		100-300Hz List No	300-500Hz List No	50-60Hz List No	d.c. List No		A	B	C	C1	E	F	H		
16	2P+E			K9204 GRY 12	K9203 GRY 3	1.5 - 4	91	117	75	54	66	5.5	30	M20	Ø23
16	3P+E	K9210 GRN 10	K9211 GRN 2			1.5 - 4	100	132	91	67	79	5.5	30	M20	Ø23
16	3P+N+E		K9252 GRN 2			1.5 - 4	104	134	91	67	79	5.5	30	M20	Ø23
32	3P+N+E		K9258 GRN 2			2.5 - 10	118	163	111	72	85	5.5	33	M25	Ø29

Earth Hour Position

*Solid or Stranded conductors

**SOCKET OUTLETS
ANGLED SURFACE MOUNTING
63 AMP**

TOP CONDUIT OR REAR CABLE ENTRY, COMPLETE WITH BLANKING PLUG

IP 44 SPLASHPROOF

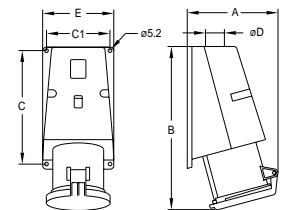

Amps	Pin. Config-uration	200-250V	380-415V	Terminal Capacity sq. mm*	Dimensions in mm					Conduit Entry D	Rear Entry mm G
		50-60Hz List No	50-60Hz List No		A	B	C	C1	E		
63	2P+E	K9274 BLU 6		4 - 16	136	254	170	95	107	M32	Ø35
63	3P+E	K9264 BLU 9	K9265 RED 6	4 - 16	136	254	170	95	107	M32	Ø35
63	3P+N+E		K9269 RED 6	4 - 16	136	254	170	95	107	M32	Ø35

Earth Hour Position

*Solid or Stranded conductors

**SOCKET OUTLETS
ANGLED SURFACE MOUNTING ELV**

IP 44 SPLASHPROOF

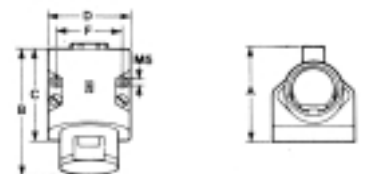

Amps	Pin. Config-uration	25V	50V	25 & 50V	Terminal Capacity sq. mm*	Dimensions in mm					Conduit Entry
		50-60Hz List No	50-60Hz List No	50-60Hz List No		A	B	C	D	F	
16	2P	K9253 VLT	K9255 WHI 12	K9257 WHI 10	4 - 10 and 2 x 6mm²	80	113	80	70	55	M25
16	3P	K9254 VLT	K9256 WHI 12		4 - 10 and 2 x 6mm²	80	113	80	70	55	M25

Minor Key Hour Position

*Solid or Stranded conductors



Commando

Industrial Plugs and Sockets

7:20

**SOCKET OUTLETS
ANGLED SURFACE MOUNTING
63 AMP**

IP 67 WATERTIGHT

Amps	Pin. Configuration	200-250V 50-60Hz		380-415V 50-60Hz		Terminal Capacity sq. mm*	Dimensions in mm					
		List No	Ⓛ	List No	Ⓛ		A	B	C	E	F	G
63	2P+E	K9857 BLU 6	Ⓛ			1 - 2.5	255	215	150	187	129	124
63	3P+E			K9858 RED 6	Ⓛ	2.5 - 6	255	215	150	187	129	124
63	3P+N+E			K9859 RED 6	Ⓛ	6 - 25	255	215	150	187	129	124

Ⓛ Earth Hour Position

*Solid or Stranded conductors

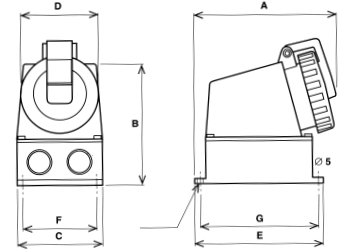

**SOCKET OUTLETS
STRAIGHT PANEL MOUNTING
16 AND 32 AMP**

ALL FLANGES HAVE THE SAME FIXING CENTRES AND OUTSIDE DIMENSIONS TO ASSIST PANEL BUILDING. SEE BELOW FOR MINIMISED FLANGE OPTION.

IP 44 SPLASHPROOF

Amps	Pin. Configuration	100-130V 50-60Hz		200-250V 50-60Hz		380-415V 50-60Hz		440-460V 50-60Hz		Terminal Capacity sq. mm *	Dimensions in mm						
		List No	Ⓛ	List No	Ⓛ	List No	Ⓛ	List No	Ⓛ		C	C1	D	D2	E	E1	H
16	2P+E	K9400 YEL 4	Ⓛ	K9401 BLU 6	Ⓛ					1.5 - 4	60-61	60-61	49	75	56	29	79
16	3P+E	K9405 YEL 4	Ⓛ	K9406 BLU 9	Ⓛ	K9407 RED 6	Ⓛ			1.5 - 4	60-61	60-61	59	75	58	30	87
16	3P+N+E	K9413 YEL 4	Ⓛ	K9414 BLU 9	Ⓛ	K9415 RED 6	Ⓛ	K9416 RED 11	Ⓛ	1.5 - 4	60-61	60-61	59	75	60	31	89
32	2P+E	K9432 YEL 4	Ⓛ	K9433 BLU 6	Ⓛ					2.5 - 10	60-61	60-61	66	75	70	34	93
32	3P+E	K9435 YEL 4	Ⓛ			K9437 RED 6	Ⓛ			2.5 - 10	60-61	60-61	66	75	70	34	93
32	3P+N+E			K9444 BLU 9	Ⓛ	K9445 RED 6	Ⓛ	K9446 RED 11	Ⓛ	2.5 - 10	60-61	60-61	66	75	70	34	93

Amps	Pin. Configuration	>50V 100-300Hz		>50V 300-500Hz		IS TRAN 50-60Hz		>50-250V d.c.		Terminal Capacity sq. mm *	Dimensions in mm						
		List No	Ⓛ	List No	Ⓛ	List No	Ⓛ	List No	Ⓛ		C	C1	D	D2	E	E1	H
16	2P+E					K9404 GRY 12	Ⓛ	K9403 GRY 3	Ⓛ	1.5 - 4	60-61	60-61	49	75	56	29	79
16	3P+E	K9410 GRN 10	Ⓛ	K9411 GRN 2	Ⓛ					1.5 - 4	60-61	60-61	59	75	58	30	87
16	3P+N+E			K9417 GRN 2	Ⓛ					1.5 - 4	60-61	60-61	59	75	60	31	89
32	3P+N+E			K9447 GRN 2	Ⓛ					2.5 - 10	60-61	60-61	66	75	70	34	93

Ⓛ Earth Hour Position

*Solid or Stranded conductors

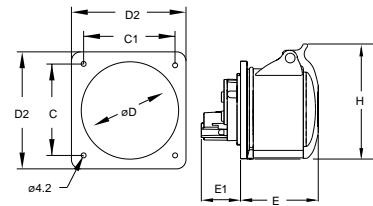

**MINIMISED FLANGE
FOR STRAIGHT PANEL MOUNTING 16 AMP OUTLETS**

NOTE: FIXING CENTRES COMPATIBLE WITH NON K SERIES PRODUCT

IP 44 SPLASHPROOF

Amps	Pin. Configuration		Dimensions in mm			
			C	C1	D	D2
16	2P+E	K9996	44-47	44-47	49	56
16	3P+E, 3P+N+E	K9997	50-52	50-52	59	66

Minimised flange can be used to replace flange supplied with straight panel mounted outlets. To be ordered as additional part.

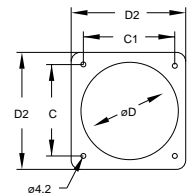



Commando

Industrial Plugs and Sockets

8:20

**SOCKET OUTLETS
ANGLED PANEL MOUNTING ELV**

IP 44 SPLASHPROOF

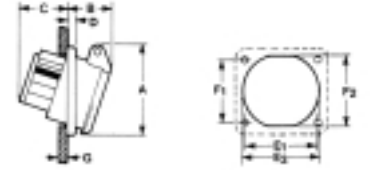

Amps	Pin. Configuration	25V 50-60Hz List No	50V 50-60Hz List No	25 & 50V 50-60Hz List No	Terminal Capacity sq. mm*	Dimensions in mm								
						A	B	C	D	E1	E2	F1	F2	G max
16	2P	K9518 VLT	K9520 WHI 12	K9522 WHI 10	4 - 10 and 2 x 6mm ²	67	35	36	6	47	52	53	56	7
16	3P	K9519 VLT	K9521 WHI 12		4 - 10 and 2 x 6mm ²	67	35	36	6	47	52	53	56	7

Minor Key Hour Position

*Solid or Stranded conductors

**SOCKET OUTLETS
STRAIGHT PANEL MOUNTING
63 AMP**

IP 44 SPLASHPROOF

Amps	Pin. Configuration	200-250V 50-60Hz List No	380-415V 50-60Hz List No	Terminal Capacity sq. mm*	Dimensions in mm						
					C	C1	D	D2	E	E1	H
63	2P+E	K9472 BLU 6		4 - 16	61	61	70	98	87	48	112
63	3P+E		K9465 RED 6	4 - 16	61	61	70	98	87	48	112
63	3P+N+E		K9470 RED 6	4 - 16	61	61	70	98	87	48	112

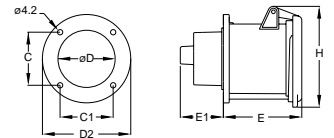

Earth Hour Position

*Solid or Stranded conductors

**SOCKET OUTLETS
ANGLED PANEL MOUNTING
16 AND 32 AMP**

IP 67 WATERTIGHT

Amps	Pin. Configuration	100-130V 50-60Hz List No	200-250V 50-60Hz List No	380-415V 50-60Hz List No	Terminal Capacity sq. mm*	Dimensions in mm						
						C	C1	D	D2	E	E1	H
16	2P+E	K9802 YEL 4	K9803 BLU 6		1 - 2.5	79.5	79.5	83	95	45	57	95
16	3P+E			K9807 RED 6	1 - 2.5	79.5	79.5	83	95	45	57	95
16	3P+N+E			K9815 RED 6	1 - 2.5	79.5	79.5	83	95	47	57	99
32	2P+E	K9865 YEL 4	K9866 BLU 6		2.5 - 6	79.5	79.5	83	95	56	61	104
32	3P+E			K9870 RED 6	2.5 - 6	79.5	79.5	83	95	56	61	104
32	3P+N+E			K9873 RED 6	2.5 - 6	79.5	79.5	83	95	56	62	111

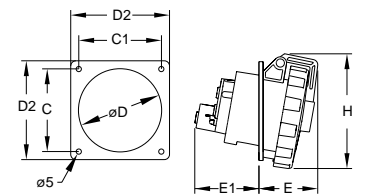

Earth Hour Position

*Solid or Stranded conductors

**SOCKET OUTLETS
ANGLED PANEL MOUNTING
63 AMP**

IP 67 WATERTIGHT

Amps	Pin. Configuration	200-250V 50-60Hz List No	380-415V 50-60Hz List No	Terminal Capacity sq. mm*	Dimensions in mm						
					C	C1	D	D2	E	E1	H
63	2P+E	K9825 BLU 6		2.5 - 6	84	80	78	104	61	86	115
63	3P+E		K9582 RED 6	2.5 - 6	84	80	78	104	61	86	115
63	3P+N+E		K9592 RED 6	16 - 50	84	80	78	104	61	86	115

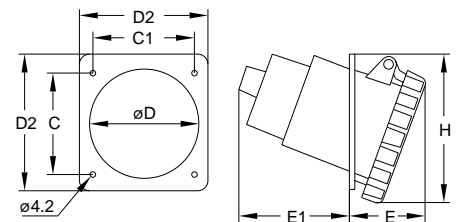

Earth Hour Position

*Solid or Stranded conductors



Commando

Industrial Plugs and Sockets

9:20

**SOCKET OUTLETS
STRAIGHT PANEL MOUNTING
63 AND 125 AMP**

IP 67 WATERTIGHT

Amps	Pin. Configuration	200-250V 50-60Hz		380-415V 50-60Hz		Terminal Capacity sq. mm*	Dimensions in mm						
		List No	Earth Hour Position	List No	Earth Hour Position		C	C1	D	D2	E	E1	H
63	2P+E	K9828 BLU 6	Earth Hour Position			6 - 25	61	61	70	98	89	48	111
63	3P+E			K9812 RED 6	Earth Hour Position	6 - 25	61	61	70	98	89	48	111
63	3P+N+E			K9822 RED 6	Earth Hour Position	6 - 25	61	61	70	98	89	48	111
125	2P+E	K9483 BLU 6	Earth Hour Position			25 - 70	71	71	88	115	100	58	122
125	3P+E			K9481 RED 6	Earth Hour Position	25 - 70	71	71	88	115	100	58	122
125	3P+N+E			K9482 RED 6	Earth Hour Position	25 - 70	71	71	88	115	100	58	122

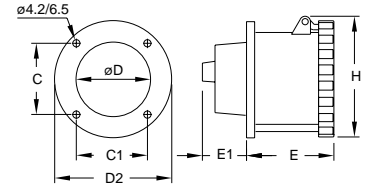

Earth Hour Position

*Solid or Stranded conductors

**SOCKET OUTLETS
ANGLED PANEL MOUNTING
16 AND 32 AMP**

IP 44 SPLASHPROOF

IP44 Outlet Angled Panel Mounted can be installed in two ways, recessed (option A) or protruding (Option B). The flange is supplied loose to enable installer to select option at time of installation. NOTE: with option B terminations must be made prior to mounting outlet to flange.

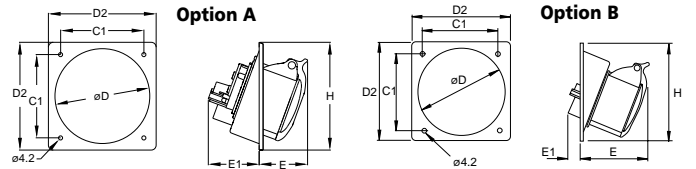

Amps	Pin. Configuration	100-130V 50-60Hz		200-250V 50-60Hz		380-415V 50-60Hz		440-460V 50-60Hz		Terminal Capacity sq. mm*	Dimensions in mm													
		List No	Earth Hour Position	List No	Earth Hour Position	List No	Earth Hour Position	List No	Earth Hour Position		Option A				Option B									
											C	C1	D	D2	E	E1	H	C	C1	D	D2	E	E1	H
16	2P+E	K9500 YEL 4	Earth Hour Position	K9501 BLU 6	Earth Hour Position	K9502 RED 9	Earth Hour Position			1.5 - 4	65	65	76.5	85	51	44	86	65	65	76.5	85	68	23	86
16	3P+E			K9506 BLU 9	Earth Hour Position	K9507 RED 6	Earth Hour Position	K9508 RED 11	Earth Hour Position	1.5 - 4	75	75	91	100	52	46	100	75	75	91	100	70	23	100
16	3P+N+E			K9514 BLU 9	Earth Hour Position	K9515 RED 6	Earth Hour Position	K9516 RED 11	Earth Hour Position	1.5 - 4	75	75	91	100	54	48	100	75	75	91	100	74	23	100
32	2P+E	K9532 YEL 4	Earth Hour Position	K9533 BLU 6	Earth Hour Position					2.5 - 10	85	85	98	110	61	53	110	85	85	98	110	88	25	110
32	3P+E					K9538 RED 6	Earth Hour Position	K9539 RED 11	Earth Hour Position	2.5 - 10	85	85	98	110	61	53	110	85	85	98	110	88	25	110
32	3P+N+E			K9542 BLU 9	Earth Hour Position	K9543 RED 6	Earth Hour Position			2.5 - 10	85	85	98	110	61	54	110	85	85	98	110	91	25	110

Earth Hour Position

*Solid or Stranded conductors

**SOCKET OUTLETS
ANGLED PANEL MOUNTING
63 AMP**

IP 44 SPLASHPROOF

Amps	Pin. Configuration	220-250V 50-60Hz		380-415V 50-60Hz		Terminal Capacity sq. mm*	Dimensions in mm						
		List No	Earth Hour Position	List No	Earth Hour Position		C	C1	D	D2	E	E1	H
63	2P+E	K9544 BLU 6	Earth Hour Position			6 - 25	84	80	92	104	62	95	111
63	3P+E			K9565 RED 6	Earth Hour Position	6 - 25	84	80	92	104	62	95	111
63	3P+N+E			K9570 RED 6	Earth Hour Position	6 - 25	84	80	92	104	62	95	111

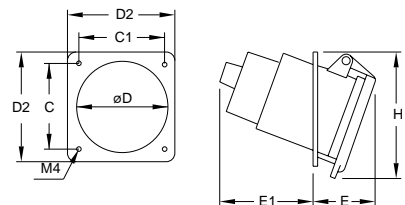

Earth Hour Position

*Solid or Stranded conductors



Commando

Industrial Plugs and Sockets

10:20

**SWITCHSOCKET OUTLETS
ANGLED SURFACE MOUNTING
16 AMP**

IP 44 SPLASHPROOF

UTILISATION CATEGORY AC 22A

With two x M20 x 1.5mm *Solid or Stranded conductors threaded conduit entries and one x 18mm knockout in both top and bottom. Supplied with blanking plugs/cable entry

Amps	Pin. Configuration	100-130V	200-250V	380-415V	Terminal Capacity sq. mm*	Dimensions in mm						Fixing Centres
		50-60Hz List No	50-60Hz List No	50-60Hz List No		A	B	C	D	E	F	
16	2P+E	K9912 YEL 4		K9914 RED 9	1.5 - 4	99	112	156	95	139	101	101 x 95
16	3P+E		K9919 BLU 9	K9920 RED 6	1.5 - 4	101	112	156	95	139	101	101 x 95

Earth Hour Position

*Solid or Stranded conductors

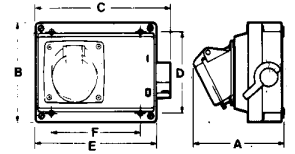

**SWITCHSOCKET OUTLETS
INTERLOCKED ANGLED
FLANGE ENTRY SURFACE MOUNTING
16, 32 AND 63 AMP**

IP 44 SPLASHPROOF

ALUMINIUM ALLOY ENCLOSURE.

16 amp and 32 amp
Supplied with FL9 flange and gland plates
Will accept auxiliary contact eg. 6813 and 6814

63 amp
Supplied with FL13 flange and gland plates
Will accept auxiliary contact 6801 and 6802
Switch can be locked in open or closed position.
Switch Utilisation Category AC 22A

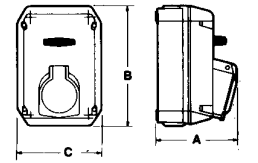

Amps	Pin. Configuration	100-130V	200-250V	380-415V	440-460V	480-500V	>50V	Terminal Capacity sq. mm*	Dimensions in mm			Fixing Centres	FL
		50-60Hz List No	50-60Hz List No	50-60Hz List No	50-60Hz List No	50-60Hz List No	>300-500Hz List No		A	B	C		
16	3P+E	K9600 YEL 4	K9601 BLU 9	K9602 RED 6	K9603 RED 11	K9604 BLK 7	K9605 GRN 2	1.5 - 10	125	200	135	91.5 x 165	9
16	3P+N+E	K9606 YEL 4	K9607 BLU 9	K9608 RED 6				1.5 - 10	125	200	135	91.5 x 165	9
32	3P+E	K9632 YEL 4	K9633 BLU 9	K9634 RED 6	K9635 RED 11	K9636 BLK 7		1.5 - 10	135	200	135	91.5 x 165	9
32	3P+N+E	K9638 YEL 4	K9639 BLU 9	K9640 RED 6	K9641 RED 11			1.5 - 10	135	200	135	91.5 x 165	9
63	3P+E		K9664 BLU 9	K9665 RED 6				6 - 25	180	230	165	91.5 x 201	13
63	3P+N+E			K9670 RED 6				6 - 25	180	230	165	91.5 x 201	13

Earth Hour Position

*Solid or Stranded conductors

**SWITCHSOCKET OUTLETS
INTERLOCKED ANGLED CONDUIT ENTRY
SURFACE MOUNTING
16, 32 AND 63 AMP**

IP 44 SPLASHPROOF

16 amp and 32 amp
With 29mm knockout at top. Will accept FL13 flange.
Bottom conduit entry supplied with PG21 to M25 x 1.5 Adaptor.

63 amp
FL13 flange entry at top.
Supplied with cover plate and gland plate.
Will accept auxiliary contact 6801 and 6802
Switch Utilisation Category AC 22A

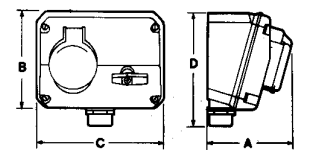

Amps	Pin. Configuration	100-130V	200-250V	380-415V	Terminal Capacity sq. mm*	Dimensions in mm				Fixing Centres	Conduit Entry
		50-60Hz List No	50-60Hz List No	50-60Hz List No		A	B	C	D		
16	2P+E	K9609 YEL 4	K9610 BLU 6		1.5 - 10	112	129	168	149	125 x 91	pg21*
16	3P+E			K9611 RED 6	1.5 - 10	114	129	168	149	125 x 91	pg21*
16	3P+N+E			K9612 RED 6	1.5 - 10	116	129	168	149	125 x 91	pg21*
32	2P+E	K9642 YEL 4	K9643 BLU 6		1.5 - 10	124	129	168	149	125 x 91	pg21*
32	3P+E			K9644 RED 6	1.5 - 10	124	129	168	149	125 x 91	pg21*
32	3P+N+E			K9645 RED 6	1.5 - 10	126	129	168	149	125 x 91	pg21*
63	2P+E		K9306 BLU 6		6 - 25	165	168	206		132 x 152	2 x 32mm
63	3P+E		K9311 BLU 9	K9312 RED 6	6 - 25	165	168	206		132 x 152	2 x 32mm
63	3P+N +E			K9322 RED 6	6 - 25	165	168	206		132 x 152	2 x 32mm

Earth Hour Position

*Solid or Stranded conductors

* fitted with M25 adaptor



Commando

Industrial Plugs and Sockets

11:20

**SWITCHSOCKET OUTLETS
INTERLOCKED ANGLED FLANGE ENTRY
SURFACE MOUNTING
16, 32 AND 63 AMP**

IP 67 WATERTIGHT

16 amp and 32 amp

With 29mm knockout at top. Will accept FL13 flange. Bottom conduit entry supplied with PG21 to M25 x 1.5 Adaptor.

63 amp

With 32mm knockouts top and bottom. Will accept FL13 flange top and bottom. Will accept auxiliary contact 6801 and 6802. Switch can be locked in open position. In closed position by removing tab. Switch Utilisation Category AC 22A

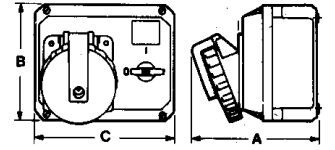

Amps	Pin. Configuration	100-130V 50-60Hz List No	200-250V 50-60Hz List No	380-415V 50-60Hz List No	440-460V 50-60Hz List No	480-500V 50-60Hz List No	Terminal Capacity sq. mm *	Dimensions in mm			Fixing Centres	Conduit Entry
								A	B	C		
16	2P+E		K9324 BLU 6				1.5 - 10	112	129	168	125 x 91	pg 21*
16	3P+E			K9327 RED 6			1.5 - 10	114	129	168	125 x 91	pg 21*
16	3P+N+E			K9330 RED 6			1.5 - 10	116	129	168	125 x 91	pg 21*
32	2P+E		K9369 BLU 6				1.5 - 10	124	129	168	125 x 91	pg 21*
32	3P+E			K9359 RED 6			1.5 - 10	124	129	168	125 x 91	pg 21*
32	3P+N+E			K9362 RED 6			1.5 - 10	126	129	168	125 x 91	pg 21*
63	2P+E	K9356 YEL 4	K9355 BLU 6				6 - 25	165	168	206	132 x 152	2 x 32mm
63	3P+E			K9342 RED 6	K9343 RED 11	K9344 BLK 6	6 - 25	165	168	206	132 x 152	2 x 32mm
63	3P+N+E			K9352 RED 6	K9353 RED 11		6 - 25	165	168	206	132 x 152	2 x 32mm

⚡ Earth Hour Position

*Solid or Stranded conductors

*Fitted with M25 adaptor

**IP 44 SPLASHPROOF APPLIANCE INLETS
ANGLED SURFACE MOUNTING
16 AND 32 AMP**

TOP CONDUIT OR REAR CABLE ENTRY, COMPLETE WITH BLANKING PLUG

IP 44 SPLASHPROOF

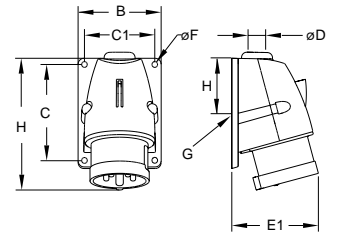

Amps	Pin. Configuration	100-130V 50-60Hz List No	200-250V 50-60Hz List No	380-415V 50-60Hz List No	480-500V 50-60Hz List No	Cable Diameter min max	Terminal Capacity sq. mm*	Dimensions in mm							Top Conduit Entry D	Rear Entry G
								B	C	C1	E1	F	H	I		
16	2P+E	K9700 YEL 4	K9701 BLU 6			8.2 14	1.5 - 10	66	75	54	72	5.5	110	30	M20	Ø23
16	3P+E			K9706 RED 6	K9707 BLK 7	8.9 16.5	1.5 - 10	79	91	67	78	5.5	124	30	M20	Ø23
16	3P+N+E	K9709 YEL 4	K9710 BLU 9	K9711 RED 6		10.1 16.5	1.5 - 10	79	91	67	81	5.5	125	30	M20	Ø23
32	2P+E	K9732 YEL 4	K9733 BLU 6			11.7 19.5	1.5 - 10	85	111	72	94	5.5	153	33	M25	Ø29
32	3P+E			K9736 RED 6	K9737 BLK 7	11.7 19.5	1.5 - 10	85	111	72	94	5.5	153	33	M25	Ø29
32	3P+N+E		K9740 BLU 9	K9741 RED 6		11.7 19.5	1.5 - 10	85	111	72	96	5.5	154	33	M25	Ø29

⚡ Earth Hour Position

*Solid or Stranded conductors

**APPLIANCE INLETS
ANGLED SURFACE MOUNTING
63AMP**

IP 44 SPLASHPROOF

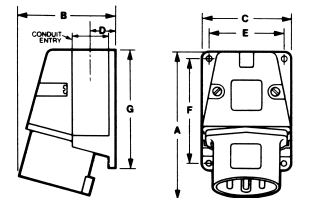

Amps	Pin. Configuration	200-250V 50-60Hz List No	380-415V 50-60Hz List No	Cable Diameter min max	Terminal Capacity sq. mm*	Dimensions in mm					Conduit Entry	Rear Entry
						C	F	E	B	A		
63	2P+E	K9775 BLU 6		14 30	6 - 25	107	170	95	117	238	32mm	Ø35
63	3P+N+E		K9768 RED 6	16.5 30	6 - 25	107	170	95	117	238	32mm	Ø35

⚡ Earth Hour Position

*Solid or Stranded conductors



Commando

Industrial Plugs and Sockets

12:20

**APPLIANCE INLETS
ANGLED SURFACE MOUNTING
63 AMP**

IP 67 WATERTIGHT

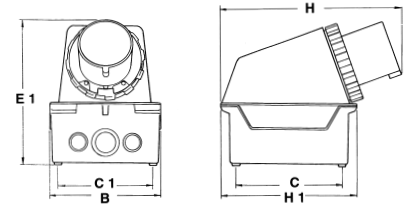

Amps	Pin. Configuration	200-250V 50-60Hz List No	380-415V 50-60Hz List No	Terminal Capacity sq. mm*	Dimensions in mm						Conduit Entry
					B	C	C1	E1	H	H1	
63	2P+E	K9826 BLU 6		6 - 25	150	124	129	205	250	186	2 x 29/37mm and 1 x 23mm top 1 x 29/37mm and 2 x 23mm knockouts bottom Will accept FL13 Flange top and bottom
63	3P+E		K9829 RED 6	6 - 25	150	124	129	205	250	186	
63	3P+N+E		K9827 RED 6	6 - 25	150	124	129	205	250	186	

Ⓛ Earth Hour Position

*Solid or Stranded conductors

**APPLIANCE INLETS
SURFACE MOUNTING
125 AMP**

IP 67 WATERTIGHT

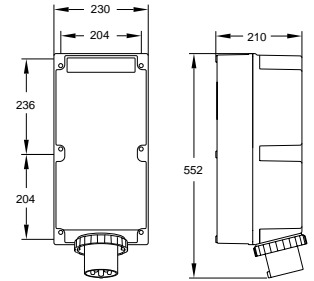

Amps	Pin. Configuration	200-250V 50-60Hz List No	380-415V 50-60Hz List No	Terminal Capacity sq. mm*	Conduit Entry
125	3P+N+E		K9884 RED 6	6 - 25	2 x 23/47mm top and bottom

Ⓛ Earth Hour Position

*Solid or Stranded conductors

**APPLIANCE INLETS
ANGLED PANEL MOUNTING
16, 32, 63 AND 125 AMP**

IP 67 WATERTIGHT

16 AND 32 AMP

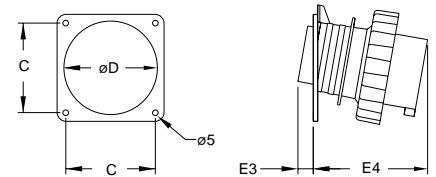

63 AND 125 AMP

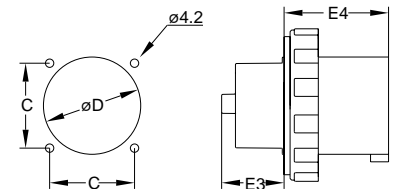

Amps	Pin. Configuration	100-130V 50-60Hz List No	200-250V 50-60Hz List No	380-415V 50-60Hz List No	Terminal Capacity sq. mm*	Dimensions in mm			
						C	D	E3	E4
16	2P+E	K9780 YEL 4	K9781 BLU 6		1.5 - 4	79.5	83	10	47
16	3P+E			K9782 RED 6	1.5 - 4	79.5	83	10	53
16	3P+N+E			K9783 RED 6	1.5 - 4	79.5	83	10	59
32	2P+E	K9784 YEL 4	K9785 BLU 6		2.5 - 10	79.5	83	12	60
32	3P+E			K9786 RED 6	2.5 - 10	79.5	83	12	60
32	3P+N+E			K9787 RED 6	2.5 - 10	79.5	83	12	67
63	2P+E	K9788 YEL 4	K9789 BLU 6		6 - 25	61	70	50	80
63	3P+E			K9790 RED 6	6 - 25	61	70	50	80
63	3P+N+E			K9791 RED 6	6 - 25	61	70	50	80
125	2P+E		K9792 BLU 6		16 - 70	71	81	56	89
125	3P+N+E			K9793 RED 6	16 - 70	71	81	56	89

Ⓛ Earth Hour Position

*Solid or Stranded conductors



Commando

Industrial Plugs and Sockets

13:20

**APPLIANCE INLETS
SURFACE MOUNTING ELV**

IP 44 SPLASHPROOF

Amps	Pin. Config-uration	25V 50-60Hz List No	Terminal Capacity sq. mm * (flexible conductors)	Dimensions in mm						Conduit Entry
				A	B	C	D	E	F	
16	2P	K9725 VLT	4 - 10 and 2 x 6mm ²	100	66	70	20	55	80	M25
16	3P	K9726 VLT	4 - 10 and 2 x 6mm ²	100	66	70	20	55	80	M25

Ⓛ Earth Hour Position

*Solid or Stranded conductors

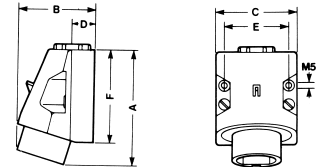

**THREE WAY ADAPTOR
16 AMP**

IP 44 SPLASHPROOF

Amps	Pin. Config-uration	100-130V 50-60Hz List No	200-250V 50-60Hz List No	380-415V 50-60Hz List No	Dimensions in mm			
		A	B	C	D			
16	2P+E	K9907 YEL 4	K9908 BLU 6		200	190	66	99
16	3P+E			K9910 RED 6	200	190	82	99
16	3P+N+E			K9911 RED 6	200	190	86	99

Ⓛ Earth Hour Position

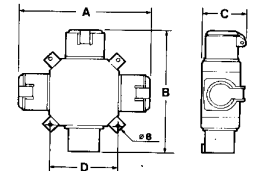

**SOCKET OUTLETS
LOOP IN SURFACE MOUNTING
16 AND 32 AMP**

IP 44 SPLASHPROOF

Amps	Pin. Config-uration	100-130V 50-60Hz List No	200-250V 50-60Hz List No	380-415V 50-60Hz List No	Cable Entry Knockouts	*Terminal Capacity sq. mm*	Fixing Centres mm
		A	B	C			
16	2P+E	K13200 YEL 4	K13201 BLU 6		2 x Ø25 top	2 x (1.5-10)	90 x 171
16	3P+E			K13207 RED 6	2 x Ø25 top	2 x (1.5-10)	90 x 171
16	3P+N+E			K13215 RED 6	2 x Ø25 top	2 x (1.5-10)	90 x 171
32	2P+E	K13232 YEL 4	K13233 BLU 6		2 x Ø25 top	2 x (2.5-10)	90 x 171
32	3P+E			K13237 RED 6	2 x Ø25 top	2 x (2.5-10)	90 x 171
32	3P+N+E			K13241 RED 6	2 x Ø25 top	2 x (2.5-10)	90 x 171

Ⓛ Earth Hour Position

*Solid or Stranded conductors

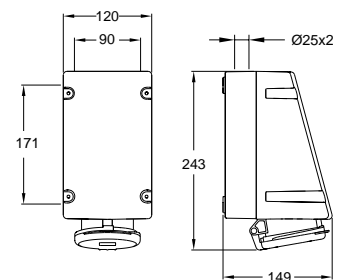



Commando

Industrial Plugs and Sockets

14:20

**SWITCHSOCKET OUTLETS
INTERLOCKED SURFACE MOUNTING
16 AND 32 AMP**

(SUITABLE FOR TOP ENTRY)

IP 44 SPLASHPROOF

Switch Utilisation Category AC 22A
Will accept auxiliary contacts **6813 and 6814**
Switch can be locked in open position.
In closed position by removing tab.

Amps	Pin. Configuration	100-130V 50-60Hz List No	200-250V 50-60Hz List No	380-415V 50-60Hz List No	Cable Entry Knockouts	Terminal Capacity sq. mm*	Fixing Centres mm
16	2P+E	K13600 YEL 4	K13601 BLU 6		2 x Ø25 top	1.5 - 4	90 x 171
16	3P+E			K13607 RED 6	2 x Ø25 top	1.5 - 4	90 x 171
16	3P+N+E			K13615 RED 6	2 x Ø25 top	1.5 - 4	90 x 171
32	2P+E	K13632 YEL 4	K13633 BLU 6		2 x Ø25 top	2.5 - 10	90 x 171
32	3P+E			K13637 RED 6	2 x Ø25 top	2.5 - 10	90 x 171
32	3P+N+E			K13641 RED 6	2 x Ø25 top	2.5 - 10	90 x 171

🔴 Earth Hour Position

*Solid or Stranded conductors

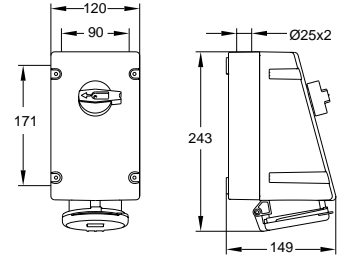

**SWITCHSOCKET OUTLETS
INTERLOCKED SURFACE MOUNTING
16 AND 32 AMP**

IP 67 WATERTIGHT

Switch Utilisation Category AC 22A
Will accept auxiliary contacts **6813 and 6814**
Switch can be locked in open position.
In closed position by removing tab.

Amps	Pin. Configuration	100-130V 50-60Hz List No	200-250V 50-60Hz List No	380-415V 50-60Hz List No	Cable Entry Knockouts	Terminal Capacity sq. mm*	Fixing Centres mm
16	2P+E	K13623 YEL 4	K13624 BLU 6		2 x Ø25 top	1.5 - 4	90 x 171
16	3P+E			K13625 RED 6	2 x Ø25 top	1.5 - 4	90 x 171
16	3P+N+E			K13626 RED 6	2 x Ø25 top	1.5 - 4	90 x 171
32	2P+E	K13653 YEL 4	K13654 BLU 6		2 x Ø25 top	2.5 - 10	90 x 171
32	3P+E			K13655 RED 6	2 x Ø25 top	2.5 - 10	90 x 171
32	3P+N+E			K13656 RED 6	2 x Ø25 top	2.5 - 10	90 x 171

🔴 Earth Hour Position

*Solid or Stranded conductors

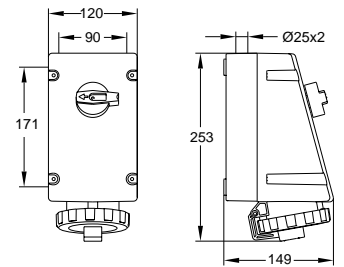

**SWITCHSOCKET OUTLETS
INTERLOCKED SURFACE MOUNTING
125 AMP**

IP 67 WATERTIGHT

Switch Utilisation Category AC 22A
Will accept auxiliary contacts **6813 and 6814**
Switch can be locked in open position.
In closed position by removing tab.

Amps	Pin. Configuration	200-250V 50-60Hz List No	380-415V 50-60Hz List No	440-460V 60Hz List No	Cable Entry Knockouts	Terminal Capacity sq. mm*
125	2P+E	K9688 BLU 6			2 x 23/47mm top and bottom	16 - 70
125	3P+E		K9691 RED 6	K9692 RED 11	2 x 23/47mm top and bottom	16 - 70
125	3P+N+E		K9694 RED 6		2 x 23/47mm top and bottom	16 - 70

🔴 Earth Hour Position

*Solid or Stranded Conductors

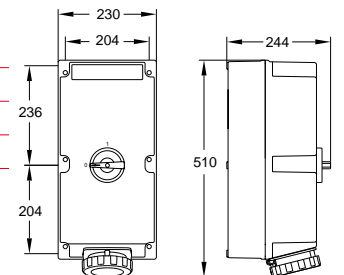



Commando

Industrial Plugs and Sockets

15:20

**SOCKET OUTLETS
SURFACE MOUNTING
16 AND 32 AMP**

SUITABLE FOR TOP ENTRY

IP 67 WATERTIGHT

Amps	Pin. Configuration	100-130V 50-60Hz List No	220-250V 50-60Hz List No	380-415V 50-60Hz List No	Terminal Capacity sq. mm*	Cable Entry Knockouts	Fixing Centres mm
16	2P+E	K9196 YEL 4	K9197 BLU 6		1 - 2.5	2 x Ø25 top	90 x 171
16	3P+E			K9198 RED 6	1 - 2.5	2 x Ø25 top	90 x 171
16	3P+N+E			K9199 RED 6	1 - 2.5	2 x Ø25 top	90 x 171
32	2P+E	K9259 YEL 4	K9260 BLU 6		2.5 - 6	2 x Ø25 top	90 x 171
32	3P+E			K9261 RED 6	2.5 - 6	2 x Ø25 top	90 x 171
32	3P+N+E			K9262 RED 6	2.5 - 6	2 x Ø25 top	90 x 171

⬇ Earth Hour Position

*Solid or Stranded conductors

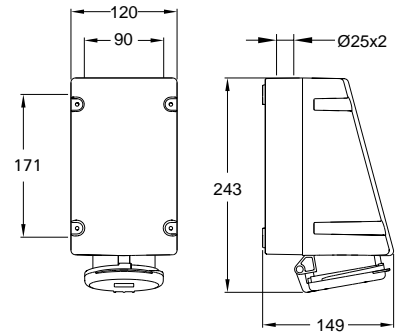

LOOP IN VERSIONS

Fitted with terminals for Loop In

Amps	Pin. Configuration	100-130V 50-60Hz List No	220-250V 50-60Hz List No	380-415V 50-60Hz List No	Terminal Capacity sq. mm*	Cable Entry Knockouts	Fixing Centres mm
16	2P+E	K13023 YEL 4	K13024 BLU 6		2 x (1.5-10)	2 x Ø25 top	90 x 171
16	3P+E			K13025 RED 6	2 x (1.5-10)	2 x Ø25 top	90 x 171
16	3P+N+E			K13026 RED 6	2 x (1.5-10)	2 x Ø25 top	90 x 171
32	2P+E	K13053 YEL 4	K13054 BLU 6		2 x (2.5-10)	2 x Ø25 top	90 x 171
32	3P+E			K13055 RED 6	2 x (2.5-10)	2 x Ø25 top	90 x 171
32	3P+N+E			K13056 RED 6	2 x (2.5-10)	2 x Ø25 top	90 x 171

⬇ Earth Hour Position

*Solid or Stranded conductors

**SOCKET OUTLETS
LOOP IN SURFACE MOUNTING
125 AMP**

IP 67 WATERTIGHT

Amps	Pin. Configuration	200-250V 50-60Hz List No	380-415V 50-60Hz List No	440-460V 60Hz List No	Cable Entry Knockouts	Terminal Capacity sq. mm*
125	2P+E	K9190 BLU 6			2 x 23/47mm top & bottom	2 x (16 - 70)
125	3P+E		K9191 RED 6	K9195 RED 11	2 x 23/47mm top & bottom	2 x (16 - 70)
125	3P+N+E		K9194 RED 6		2 x 23/47mm top & bottom	2 x (16 - 70)

⬇ Earth Hour Position

*Solid or Solid Stranded conductors

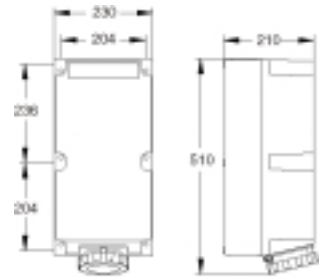



Commando
Combination Unit

16:20

SOCKET OUTLETS
SINGLE PRE-WIRED WITH 30mA RCD
16 AND 32 AMP

IP 44 SPLASHPROOF

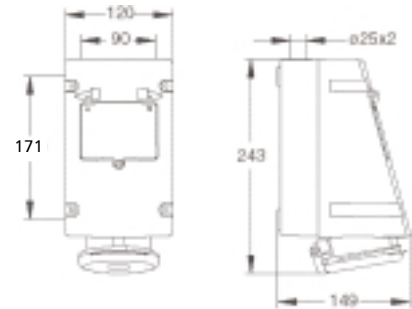

Amps	Pin. Configuration	100-130V 50-60Hz		200-250V 50-60Hz		380-415V 50-60Hz		RCD Terminal Capacity sq. mm*		Earth Terminal Capacity sq. mm		Cable Entry Knockouts	
		List No	Ⓛ	List No	Ⓛ	List No	Ⓛ	min	max	min	max		
16	2P+E	K13413 YEL	4	K13414 BLU	6			1.5	35	2.5	25	2 x Ø25	top
16	3P+E					K13415 RED	6	1.5	35	2.5	25	2 x Ø25	top
16	3P+N+E					K13416 RED	6	1.5	35	2.5	25	2 x Ø25	top
32	2P+E			K13433 BLU	6			2.5	35	2.5	25	2 x Ø25	top
32	3P+E					K13434 RED	6	2.5	35	2.5	25	2 x Ø25	top
32	3P+N+E					K13435 RED	6	2.5	35	2.5	25	2 x Ø25	top

Ⓛ Earth Hour Position

*Solid or Stranded conductors

SWITCHSOCKET OUTLETS
INTERLOCKED PRE-WIRED WITH 30mA RCD
16 AND 32 AMP

IP 44 SPLASHPROOF

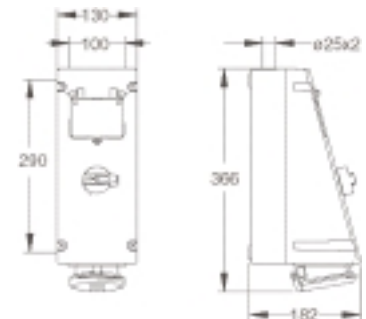

Amps	Pin. Configuration	100-130V 50-60Hz		200-250V 50-60Hz		380-415V 50-60Hz		RCD Terminal Capacity sq. mm*		Earth Terminal Capacity sq. mm		Cable Entry Knockouts	
		List No	Ⓛ	List No	Ⓛ	List No	Ⓛ	min	max	min	max		
16	2P+E	K13309 YEL	4	K13310 BLU	6			1.5	35	2.5	25	2 x Ø25	top
16	3P+E					K13311 RED	6	1.5	35	2.5	25	2 x Ø25	top
16	3P+N+E					K13312 RED	6	1.5	35	2.5	25	2 x Ø25	top
32	2P+E	K13342 YEL	4	K13343 BLU	6			2.5	35	2.5	25	2 x Ø25	top
32	3P+E					K13344 RED	6	2.5	35	2.5	25	2 x Ø25	top
32	3P+N+E					K13345 RED	6	2.5	35	2.5	25	2 x Ø25	top

Ⓛ Earth Hour Position

*Solid or Stranded conductors



Commando
Combination Unit

17:20

SOCKET OUTLETS
SINGLE PRE-WIRED WITH 30mA RCD
16 AND 32 AMP

IP 67 WATERTIGHT

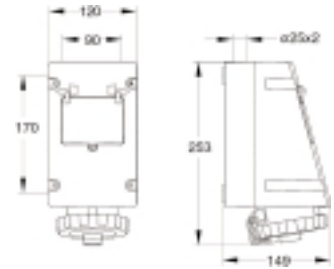

Amps	Pin. Configuration	100-130V 50-60Hz List No		200-250V 50-60Hz List No		380-415V 50-60Hz List No		RCD Terminal Capacity sq. mm*		Earth Terminal Capacity sq. mm		Cable Entry Knockouts
			Ⓛ		Ⓛ		Ⓛ	min	max	min	max	
16	2P+E	K13713 YEL	4	K13714 BLU	6			1.5	35	2.5	25	2 x Ø25 top
16	3P+E					K13715 RED	6	1.5	35	2.5	25	2 x Ø25 top
16	3P+N+E					K13716 RED	6	1.5	35	2.5	25	2 x Ø25 top
32	2P+E			K13733 BLU	6			2.5	35	2.5	25	2 x Ø25 top
32	3P+E					K13734 RED	6	2.5	35	2.5	25	2 x Ø25 top
32	3P+N+E					K13735 RED	6	2.5	35	2.5	25	2 x Ø25 top

Ⓛ Earth Hour Position

*Solid or Stranded conductors

SWITCHSOCKET OUTLETS
INTERLOCKED PRE-WIRED WITH 30mA RCD
16 AND 32 AMP

IP 67 WATERTIGHT

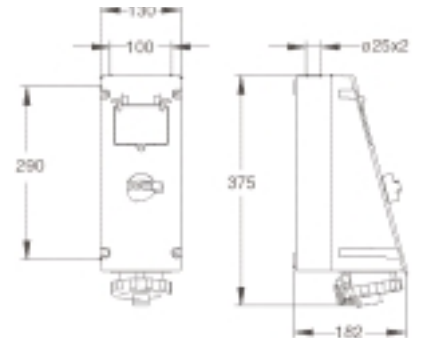

Amps	Pin. Configuration	100-130V 50-60Hz List No		200-250V 50-60Hz List No		380-415V 50-60Hz List No		RCD Terminal Capacity sq. mm*		Earth Terminal Capacity sq. mm		Cable Entry Knockouts	Fixing Centres
			Ⓛ		Ⓛ		Ⓛ	min	max	min	max		
16	2P+E	K13346 YEL	6	K13348 BLU	6			1.5	35	2.5	25	2 x Ø25 top	100 x 290
16	3P+E					K13350 RED	6	1.5	35	2.5	25	2 x Ø25 top	100 x 290
16	3P+N+E					K13351 RED	6	1.5	35	2.5	25	2 x Ø25 top	100 x 290
32	2P+E	K13347 YEL	6	K13349 BLU	6			2.5	35	2.5	25	2 x Ø25 top	100 x 290
32	3P+E					K13352 RED	6	2.5	35	2.5	25	2 x Ø25 top	100 x 290
32	3P+N+E					K13353 RED	6	2.5	35	2.5	25	2 x Ø25 top	100 x 290

Ⓛ Earth Hour Position

*Solid or Stranded conductors



Commando

Modular Combi

18:20

**MODULAR COMBI UNITS
TWIN SURFACE SOCKET OUTLET
16 AND 32 AMP**

IP 44 SPLASHPROOF

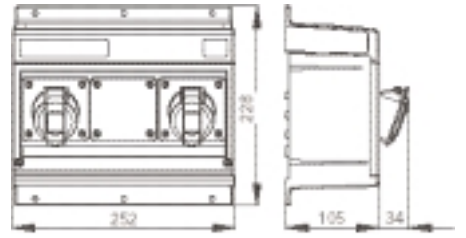

Amps	Pin. Config-uration	100-130V 50-60Hz		200-250V 50-60Hz		Terminal Capacity		Cable Entry Knockouts		
		List No	Earth Hour Position	List No	Earth Hour Position	sq mm* min	max	Top	Bottom	
16	2P+E	K13143 YEL	4	K13144 BLU	6	PREWIRED	1.5	6	2 x Ø25 + 2 x Ø38	3 x Ø47.5
16	2P+E	K13043 YEL	4	K13044 BLU	6	UNWIRED	1.5	6	2 x Ø25 + 2 x Ø38	3 x Ø47.5

🔴 Earth Hour Position

*Solid or Stranded conductors

**MODULAR COMBI UNITS
TRIPLE SURFACE SOCKET OUTLET
WITH SINGLE 30mA RCD PROTECTION
16 AMP**

IP 44 SPLASHPROOF

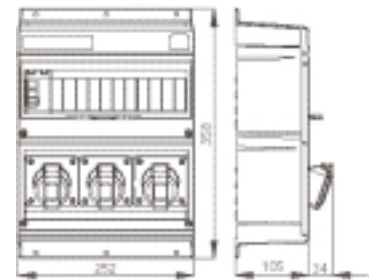

Amps	Pin. Config-uration	100-130V 50-60Hz		200-250V 50-60Hz		RCD Terminal Capacity		Earth Terminal Capacity		Cable Entry Knockouts	
		List No	Earth Hour Position	List No	Earth Hour Position	sq mm* min	max	sq mm min	max	Top	Bottom
16	2P+E	K13193 YEL	4	K13194 BLU	6	1.5	35	2.5	25	2 x Ø25 + 2 x Ø38	3 x Ø47.5

🔴 Earth Hour Position

*Solid or Stranded conductors



Commando

Modular Combi

19:20

**MODULAR COMBI UNITS
TWIN SURFACE SOCKET OUTLET
WITH INDIVIDUAL 30mA
RCD PROTECTION
16 AND 32 AMP**

IP 44 SPLASHPROOF

with 16A outlets (2P+E)

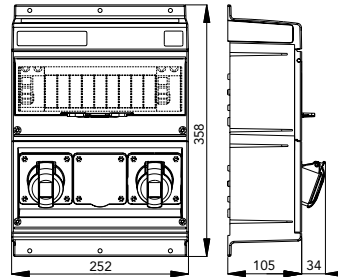

with 16A (3P+E, 3P+N+E) and 32A outlets (2P+E, 3P+E, 3P+N+E)

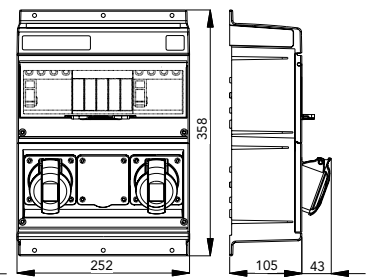

Amps	Pin. Config-uration	100-130V 50-60Hz List No	200-250V 50-60Hz List No	380-415V 50-60Hz List No	RCD Terminal Capacity sq mm*		Earth Terminal Capacity sq mm		Cable Entry Knockouts	
					min	max	min	max	Top	Bottom
16	2P+E	K13173 YEL 4	K13174 BLU 6		1.5	35	2.5	25	2 x Ø25 + 2 x Ø38	3 x Ø47.5
16	3P+E			K13175 RED 6	1.5	35	2.5	25	2 x Ø25 + 2 x Ø38	3 x Ø47.5
16	3P+N+E			K13176 RED 6	1.5	35	2.5	25	2 x Ø25 + 2 x Ø38	3 x Ø47.5
32	2P+E		K13184 BLU 6		2.5	35	2.5	25	2 x Ø25 + 2 x Ø38	3 x Ø47.5
32	3P+E			K13185 RED 6	2.5	35	2.5	25	2 x Ø25 + 2 x Ø38	3 x Ø47.5
32	3P+N+E			K13186 RED 6	2.5	35	2.5	25	2 x Ø25 + 2 x Ø38	3 x Ø47.5

Ⓛ Earth Hour Position

*Solid or Stranded conductors

**SOCKET OUTLETS
SINGLE PRE-WIRED WITH 30mA RCD
63 AMP**

IP 44 SPLASHPROOF

with 2P+E outlets

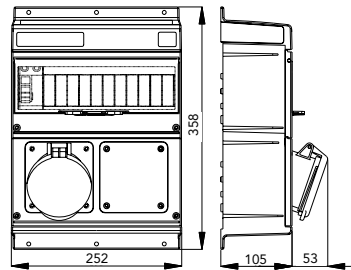

with 3P+E and 3P+N+E outlets

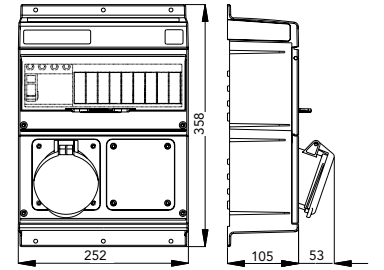

Amps	Pin. Config-uration	200-250V 50-60Hz List No	380-415V 50-60Hz List No	RCD Terminal Capacity sq. mm*		Earth Terminal Capacity sq. mm		Cable Entry Knockouts	
				min	max	min	max	Top	Bottom
63	2P+E	K13463 BLU 6		6	35	2.5	25	2 x Ø25/2 x Ø38	3 x Ø47.5
63	3P+E		K13464 RED 6	6	35	2.5	25	2 x Ø25/2 x Ø38	3 x Ø47.5
63	3P+N+E		K13465 RED 6	6	35	2.5	25	2 x Ø25/2 x Ø38	3 x Ø47.5

Ⓛ Earth Hour Position

*Solid or Stranded conductors



Commando
Modular Combi
 20:20

COMBI BLOCKS
THREE WAY
16 AMP

IP 44 SPLASHPROOF

Amps	Pin. Config-uration	100-130V 50-60Hz		200-250V 50-60Hz		*Terminal Capacity sq.mm	Cable Diameter		Dimensions in mm							
		List No	4	List No	6		min	max	A	B	C	D	E	F	H	
16	2P+E	13503	4	13504	6	1 - 2.5	7	24	360	49	115	30	55	407	172	

🔴 Earth Hour Position

*Solid or Stranded conductors

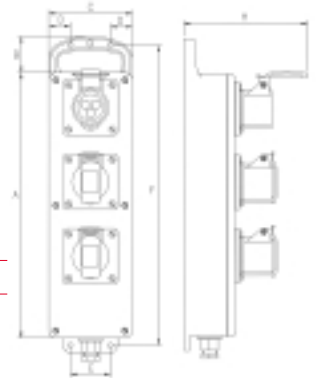

COMBI BLOCKS
TWO WAY
16 AMP

IP 56 SPLASHPROOF

Amps	Pin. Config-uration	100-130V 50-60Hz		200-250V 50-60Hz		*Terminal Capacity sq.mm	Cable Diameter		Dimensions in mm							
		List No	4	List No	6		min	max	A	B	C	D	E	F	H	
16	2P+E	13507	4	13508	6	1 - 2.5	7	24	360	49	115	30	55	407	158	

🔴 Earth Hour Position

*Solid or Stranded conductors

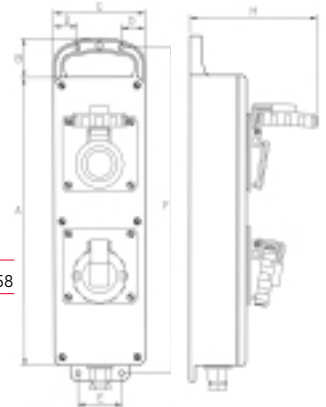

COMBI BLOCKS
TWO WAY 30mA RCD PROTECTED
16 AMP

IP 44 SPLASHPROOF

Amps	Pin. Config-uration	100-130V 50-60Hz		200-250V 50-60Hz		*Terminal Capacity sq.mm	Cable Diameter		Dimensions in mm							
		List No	4	List No	6		min	max	A	B	C	D	E	F	H	
16	2P+E	13505	4	13506	6	1 - 2.5	7	24	360	49	115	30	55	407	158	

🔴 Earth Hour Position

*Solid or Stranded conductors

