

**ART.: 8431174073310**

EB431 LED FLOOD REFLECTOR

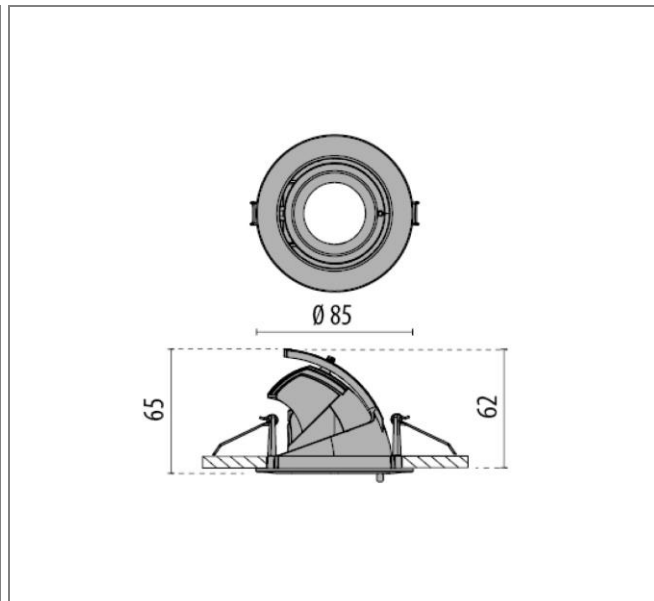

Art.: 8431174073310, EB431 LED, 9W, 3000K, Driver static, direkt / flood (2 x 23°-29°), White, Recessed LED luminaire for indoors, consisting of: Die-cast aluminum spotlight body and ring, powder-coated, Reflector can be swivelled horizontally inwards and outwards thanks to the unique swivel mechanism, Adjustable about 60° (from -15° up to 45°, rotatable about 355°, High-brilliance spherical faceted reflector for maximum lamp performance and neutral colour rendering, Reflector in Flood design, Colour rendering index Ra > 90, Colour tolerance according to MacAdam ≤ 3 SDCM Toolless mounting, Complete with electric converter, Anchor springs, Complete with clear safety glass pane

<b>Connected load</b>	9 W
<b>Luminous flux</b>	880 lm
<b>Efficiency</b>	98 lm/W
<b>Colour temperature</b>	3000K
<b>Colour rendering (CRI)</b>	80
<b>IP class</b>	20
<b>Nominal voltage</b>	220 – 240 V
<b>Colour</b>	RAL 9010

