

HF14FF

MINIATURE HIGH POWER RELAY



File No.:E134517



File No.:R50140759



File No.:CQC10002046169



Features

- 10A switching capability
- 5kV dielectric strength (between coil and contacts)
- Sockets available
- Plastic sealed and flux proofed types available
- UL insulation system: Class F available
- Environmental friendly product (RoHS compliant)
- Outline Dimensions: 29.0mm x 13.0mm x 26.0mm

CONTACT DATA

Contact arrangement	1A, 1C
Contact resistance ¹⁾	50mΩ max.(at 1A 24VDC)
Contact material	AgSnO ₂ , AgNi, AgCdO
Contact rating	Resistive: 10A 277VAC/30VDC TV-5 120VAC
Max. switching voltage	277VAC / 30VDC
Max. switching current	10A
Max. switching power	2770VA / 300W
Mechanical endurance	1 x 10 ⁷ OPS
Electrical endurance	1 x 10 ⁵ OPS (10A 277VAC, Resistive load, Room temp., 1s on 9s off) 1 x 10 ⁵ OPS (10A 30VDC, Resistive load, Room temp., 1s on 9s off)

Notes: 1) The data shown above are initial values.
2) For plastic sealed type, the venting-hole should be excised in electrical endurance test.

CHARACTERISTICS

Insulation resistance	1000MΩ (at 500VDC)	
Dielectric strength	Between coil & contacts	5000VAC 1min
	Between open contacts	1000VAC 1min
Operate time (at nomi. volt.)	15ms max.	
Release time (at nomi. volt.)	5ms max.	
Vibration resistance	10Hz to 55Hz 1.5mm DA	
Shock resistance	Functional	98m/s ²
	Destructive	980m/s ²
Humidity	5% to 85% RH	
Ambient temperature	-40°C to 70°C	
Termination	PCB	
Unit weight	Approx. 18g	
Construction	Plastic sealed, Flux proofed	

Notes: 1) The data shown above are initial values.
2) Please find coil temperature curve in the characteristic curves below.
3) UL insulation system: Class F, Class B.

COIL

Coil power	Approx. 530mW
------------	---------------

COIL DATA

at 23°C

Nominal Voltage VDC	Pick-up Voltage VDC max. ²⁾	Drop-out Voltage VDC min. ²⁾	Max. Voltage VDC ³⁾	Coil Resistance Ω
3	2.25	0.3	4.2	17 x (1±10%)
5	3.75	0.5	7.0	47 x (1±10%)
6	4.50	0.6	8.4	68 x (1±10%)
9	6.75	0.9	12.6	160 x (1±10%)
12	9.00	1.2	16.8	275 x (1±10%)
18	13.5	1.8	25.2	620 x (1±10%)
24	18.0	2.4	33.6	1100 x (1±10%)
48	36.0	4.8	67.2	4170 x (1±10%)
60	45.0	6.0	84.0	7000 x (1±10%)

Notes: 1) When requiring pick-up voltage < 75% of nominal voltage, special order allowed.
2) The data shown above are initial values.
3) Maximum voltage refers to the maximum voltage which relay coil could endure in a short period of time.
4) Under ambient temperature, applying more than 80% of rating voltage to coil, relay will take action accordingly. But in order to meet the stated product performance, please apply rated voltage to coil.

SAFETY APPROVAL RATINGS

UL/CUL	AgCdO	1 Form A	TV-5 120VAC 10A 277VAC General purpose 10A 30VDC Resistive 1/3HP 250VAC 1/4HP 125VAC
		1 Form C	TV-5 120VAC 10A 277VAC General purpose 10A 30VDC Resistive 1/3HP 250VAC NO:1/4HP 125VAC
TÜV	AgSnO ₂ AgNi		10A 277VAC General purpose 10A 30VDC Resistive 1/3HP 250VAC 1/4HP 125VAC TV-5 120VAC
			10A 250VAC 10A 30VDC

Notes: 1) All values unspecified are at room temperature.
2) Only typical loads are listed above. Other load specifications can be available upon request.



HONGFA RELAY
ISO9001, ISO/TS16949, ISO14001, OHSAS18001, IECQ QC 080000 CERTIFIED

2018 Rev. 1.00

ORDERING INFORMATION

Type	HF14FF / 012 -1H S T F (XXX)
Coil voltage	3, 5, 6, 9, 12, 18, 24, 48, 60VDC
Contact arrangement	1H: 1 Form A 1Z: 1 Form C
Construction ¹⁾	S: Plastic sealed(No smoky-gray cover) Nil: Flux proofed
Contact material	T: AgSnO ₂ 3: AgNi Nil: AgCdO
Insulation standard	F: Class F Nil: Class B
Special code ⁴⁾	XXX: Customer special requirement Nil: Standard

- Notes:** 1) We recommend flux proofed types for a clean environment (free from contaminations like H₂S, SO₂, NO₂, dust, etc.). We suggest to choose plastic sealed types and validate it in real application for an unclean environment (with contaminations like H₂S, SO₂, NO₂, dust, etc).
- 2) Contact is recommended for suitable condition and specifications if water cleaning or surface process is involved in assembling relays on PCB.
- 3) The standard type is made of black cover. If smoke cover is required, please add a special suffix (611) when ordering. Please take note that smoke cover is only available for flux proofed type.
- 4) The customer special requirement express as special code after evaluating by Hongfa.

OUTLINE DIMENSIONS, WIRING DIAGRAM AND PC BOARD LAYOUT

Unit: mm

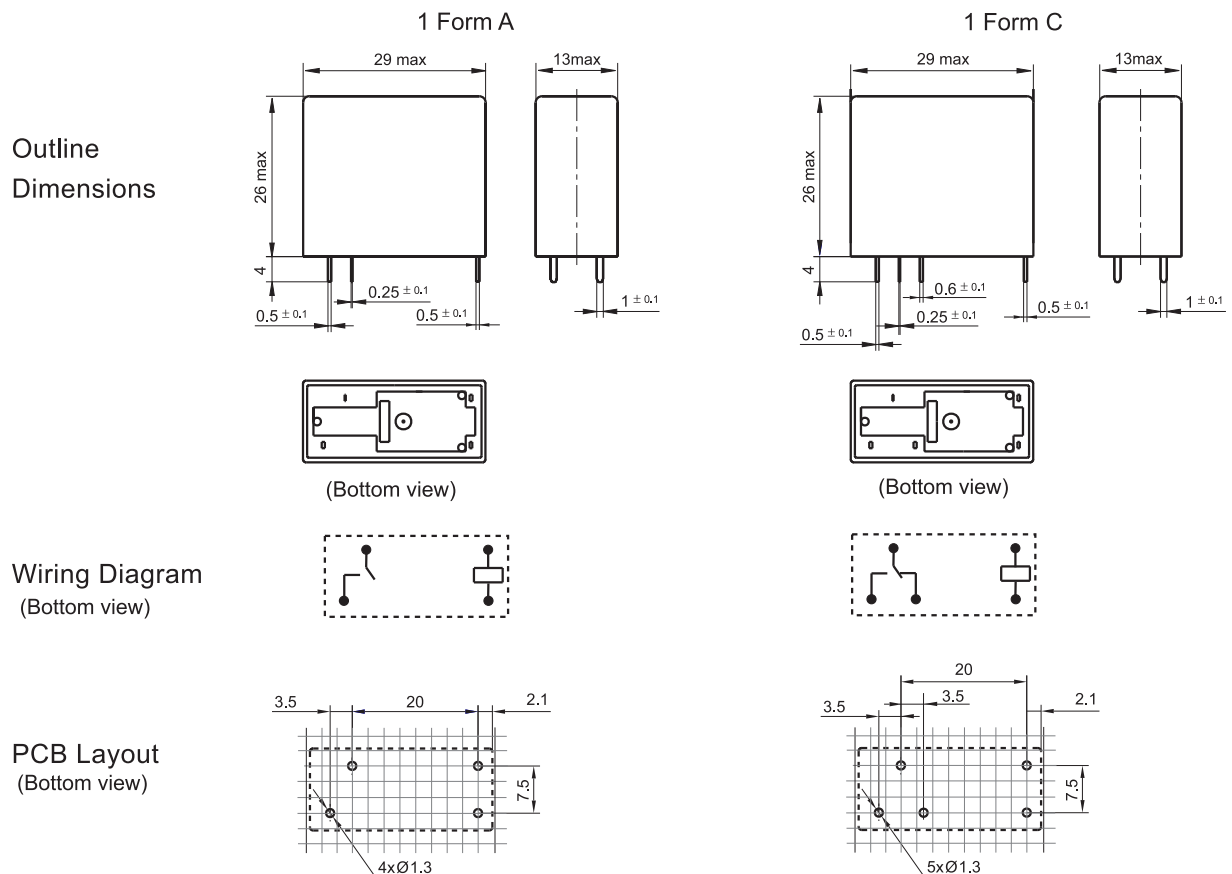

- Remark:** 1) In case of no tolerance shown in outline dimension: outline dimension ≤ 1 mm, tolerance should be ± 0.2 mm; outline dimension > 1 mm and ≤ 5 mm, tolerance should be ± 0.3 mm; outline dimension > 5 mm, tolerance should be ± 0.4 mm.
- 2) The tolerance without indicating for PCB layout is always ± 0.1 mm.
- 3) The width of the gridding is 2.5mm.

CHARACTERISTIC CURVES

ENDURANCE CURVE

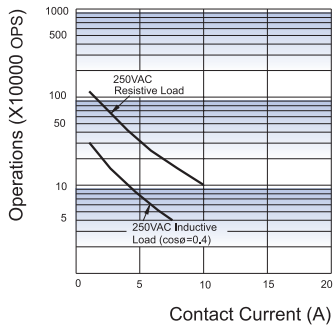

Test conditions:
NO, Resistive load,
Flux proofed, Room temp., 1s on 9s off.

COIL TEMPERATURE RISE

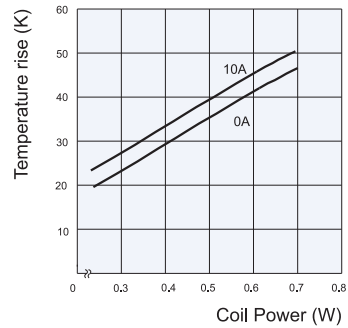

Relay Sockets

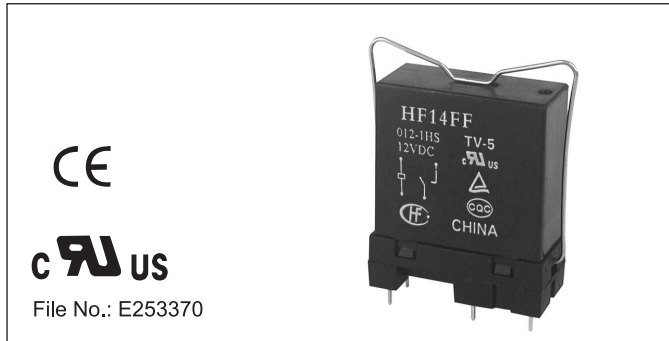

Features

- The insulation resistance is 1000MΩ
- Three mounting types are available: PCB, screw mounting and DIN rail mounting.
- With finger protection device
- Many kinds of plug-in modules are available with the function of energizing indication and wiring protection.
- Environmental friendly product (RoHS compliant)

CHARACTERISTICS

Type	Nominal Voltage	Nominal Current	Ambient Temperature	Dielectric Strength _s	Screw Torque	Wire Strip Length	Unit weight
14FF-1Z-A1	250VAC	10A	-40 °C to 70 °C	5000VAC	—	—	Approx. 3g
14FF-1Z-C2	250VAC	10A	-40 °C to 70 °C	5000VAC	0.6N · m	7mm	Approx. 33g
14FF-1Z-C3	250VAC	10A	-40 °C to 70 °C	5000VAC	0.6N · m	7mm	Approx. 39g

OUTLINE DIMENSIONS, WIRING DIAGRAM AND PC BOARD LAYOUT

Unit: mm

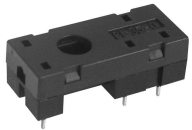
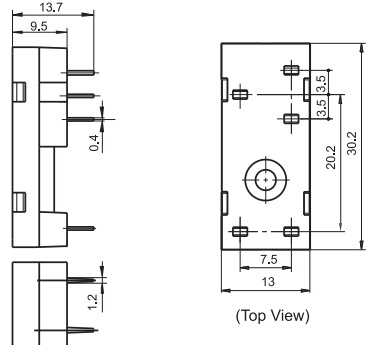
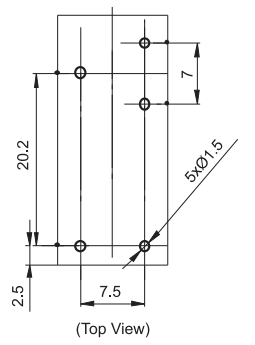
Socket	Outline Dimensions	Wiring Diagram / PCB Layout	Components Available
14FF-1Z-A1  PCB terminal, PCB or Screw mounting	 (Top View)	 (Top View)	metallic retainer 14FF-H2 remarks: the dielectric strength can reach 1500VAC that sockets mounted 14FF-H2

OUTLINE DIMENSIONS, WIRING DIAGRAM AND PC BOARD LAYOUT

Unit: mm

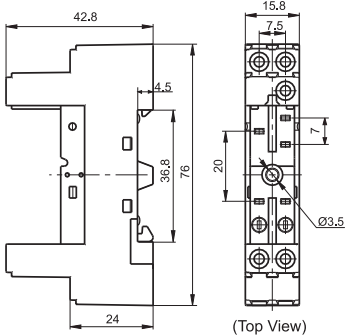
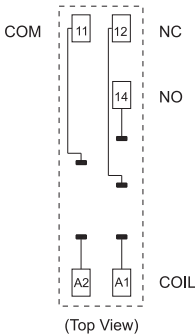
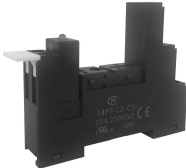
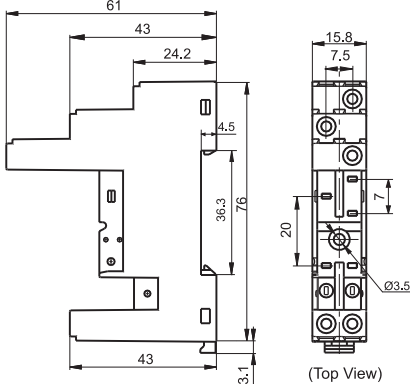
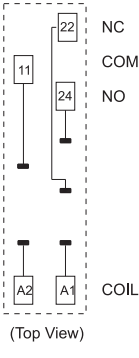
Socket	Outline Dimensions	Wiring Diagram / PCB Layout	Components Available
<p>14FF-1Z-C2</p>  <p>Screw terminal, PCB or Screw mounting With finger protection device</p>	 <p>(Top View)</p>	 <p>(Top View)</p>	<p>plastic retainer 14FF-H6</p> <p>marker 14FF-M1</p> <p>plug-in module HFAA to HFHU*</p>
<p>14FF-1Z-C3</p>  <p>Screw terminal DIN rail or Screw mounting With finger protection device</p>	 <p>(Top View)</p>	 <p>(Top View)</p>	<p>plastic retainer 14FF-H6</p> <p>marker 14FF-M1</p> <p>plug-in module HFAA to HFHU*</p>

Notes: * Please refer to the product datasheet if plug-in module is required.

DIMENSION OF RELATED COMPONENT (AVAILABLE)

Unit: mm

Retainer

14FF-H2 (Metallic retainer)

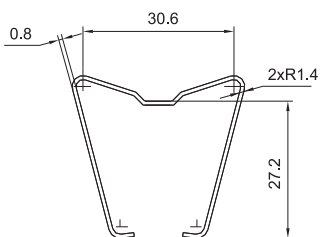

14FF-H6 (Plastic retainer)

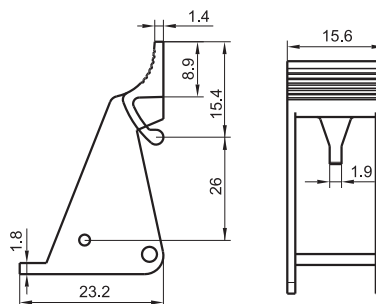

Marker

14FF-M1

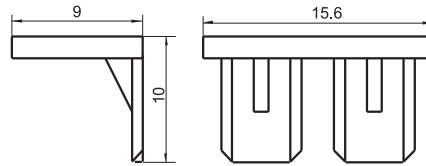

Things to be noticed when selecting sockets:

1. Please choose suitable relay socket according to the actual mounting environment, relay contact poles and terminal layout. If there is any query on selection, please contact Hongfa for the technical service.
2. Socket which can be mounted with markers is furnished with a marker; as for other related components, they should be selected separately. Please do give clear indication of the types of relay sockets and related components you choose while placing order.
3. The above is only an example of typical socket and related component type which is suitable to HF14FF relay. If you have any special requirements, please contact us.
4. Main outline dimension(L, W, H) ≥ 50 mm, tolerance should be ± 1 mm; outline dimension > 20 mm and < 50 mm, tolerance should be ± 0.5 mm; outline dimension ≤ 20 mm, tolerance should be ± 0.3 mm.
5. DIN rail mounting: recommend to use standard rail $35 \times 7.5 \times 1$ mm, $35 \times 15 \times 1$ mm.

Disclaimer

The specification is for reference only. See to "Terminology and Guidelines" for more information. Specifications subject to change without notice. We could not evaluate all the performance and all the parameters for every possible application. Thus the user should be in a right position to choose the suitable product for their own application. If there is any query, please contact Hongfa for the technical service. However, it is the user's responsibility to determine which product should be used only.