



CIRCULAR CONDUCTOR TERMINAL 2 CABLES WITH AUXILIARY CONDUCTOR 3 PCS. ACCESSORY FOR: 3VA1/2 1000



Model	
Product brand name	SETRON
Product designation	accessories

Certificates			
General Product Approval	EMC	Declaration of Conformity	other
			Miscellaneous



[Miscellaneous](#)

Further information

Information- and Downloadcenter (Catalogs, Brochures,...)
<http://www.siemens.com/lowvoltage/catalogs>

Industry Mall (Online ordering system)
<https://mall.industry.siemens.com/mall/en/en/Catalog/product?mfb=3VA9503-0JG23>

Service&Support (Manuals, Certificates, Characteristics, FAQs,...)
<https://support.industry.siemens.com/cs/ww/en/ps/3VA9503-0JG23>

Image database (product images, 2D dimension drawings, 3D models, device circuit diagrams, ...)
http://www.automation.siemens.com/bilddb/cax_en.aspx?mfb=3VA9503-0JG23

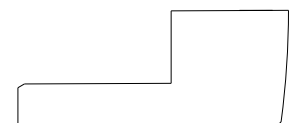
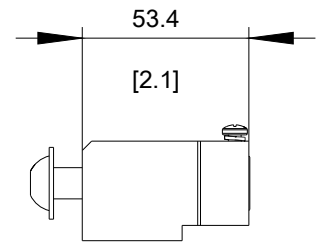
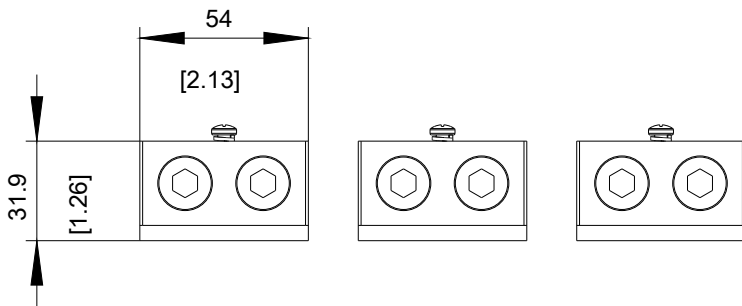
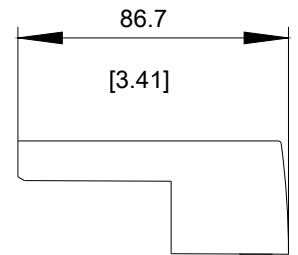
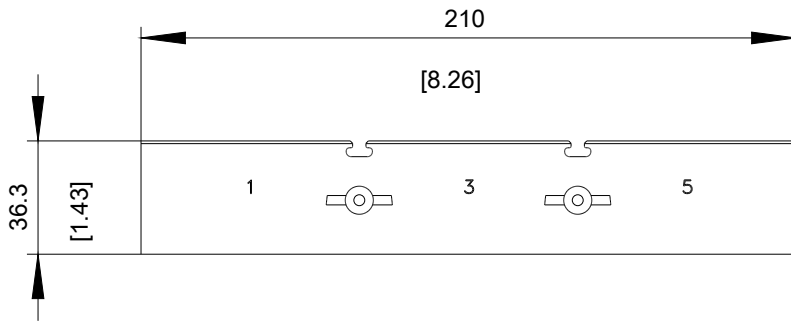

last modified:

08/28/2017