

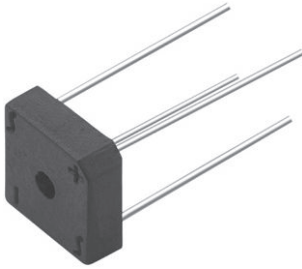

Single Phase Rectifier Bridge, 3 A, 6 A



D-72

FEATURES

- Suitable for printed circuit board or chassis mounting
- Compact construction
- High surge current capability
- Material categorization: for definitions of compliance please see www.vishay.com/doc?99912



RoHS COMPLIANT

DESCRIPTION

The VS-KBPC series of single phase rectifier bridge consists of four silicon junctions connected as a full bridge. These devices are intended for general use in industrial and consumer equipment.

PRIMARY CHARACTERISTICS	
$I_{O(AV)}$	3.0 A to 6.0 A
V_{RRM}	50 V to 1000 V
Package	D-72
Circuit configuration	Single phase bridge

MAJOR RATINGS AND CHARACTERISTICS				
SYMBOL	CHARACTERISTICS	VALUES KBPC1	VALUES KBPC6	UNITS
I_o		3	6	A
	T_C	50	50	°C
I_{FSM}	50 Hz	50	125	A
	60 Hz	55	137	
I^2t	50 Hz	12.5	78	A ² s
	60 Hz	11.4	71	
V_{RRM}	Range	50 to 1000		V
T_J		-40 to 150		°C

ELECTRICAL SPECIFICATIONS

VOLTAGE RATINGS			
PART NUMBER	V_{RRM} , MAXIMUM REPETITIVE PEAK REVERSE VOLTAGE V	V_{RSM} , MAXIMUM NON-REPETITIVE PEAK REVERSE VOLTAGE V	V_{RMS} , MAXIMUM RECOMMENDED RMS SUPPLY VOLTAGE V
VS-KBPC1005	50	50	20
VS-KBPC101	100	100	40
VS-KBPC102	200	200	80
VS-KBPC104	400	400	125
VS-KBPC106	600	600	250
VS-KBPC108	800	800	380
VS-KBPC110	1000	1000	500
VS-KBPC6005	50	50	20
VS-KBPC601	100	100	40
VS-KBPC602	200	200	80
VS-KBPC604	400	400	125
VS-KBPC606	600	600	250
VS-KBPC608	800	800	380
VS-KBPC610	1000	1000	500



FORWARD CONDUCTION						
PARAMETER	SYMBOL	TEST CONDITIONS		VALUES KBPC1	VALUES KBPC6	UNITS
Maximum DC output current	I_O	$T_C = 50\text{ }^\circ\text{C}$, resistive or inductive load		3.0	6.0	A
		$T_C = 50\text{ }^\circ\text{C}$, capacitive load		2.4	4.7	
Maximum peak one cycle, non-repetitive surge current	I_{FSM}	$t = 10\text{ ms}$, 20 ms	Following any rated load condition and with rated V_{RRM} reapplied	50	125	
		$t = 8.3\text{ ms}$, 16.7 ms		55	137	
Maximum I^2t capability for fusing	I^2t	$t = 10\text{ ms}$	Initial $T_J = T_J$ maximum 100 % V_{RRM} reapplied	12.5	78	A ² s
		$t = 8.3\text{ ms}$		11.4	71	
		$t = 10\text{ ms}$		17.7	110	
		$t = 8.3\text{ ms}$		16.1	1000	
Maximum $I^2\sqrt{t}$ capability for fusing	$I^2\sqrt{t}$	$t = 0.1\text{ ms}$ to 10 ms, no voltage reapplied		177	1105	A ² \sqrt{s}
Maximum peak forward voltage per diode	V_{FM}	$I_{FM} = 0.5 \times I_O$, $T_J = 25\text{ }^\circ\text{C}$		1.1	1.2	V
Typical peak reverse leakage per diode	I_{RM}	$T_J = 25\text{ }^\circ\text{C}$, 100 % V_{RRM}		10	10	mA
		$T_J = 150\text{ }^\circ\text{C}$, 100 % V_{RRM}		1.0	1.0	
Operating frequency range	f			40 to 1000		Hz
Maximum repetitive peak reverse voltage range	V_{RRM}			50 to 1000		V

THERMAL AND MECHANICAL SPECIFICATIONS				
PARAMETER	SYMBOL	VALUES KBPC1	VALUES KBPC6	UNITS
Operating and storage temperature range	T_J, T_{Stg}	-40 to 150		$^\circ\text{C}$
Thermal resistance, junction to case	R_{thJC}	-	-	K/W
Approximate weight		5	6	g
		0.18	0.21	oz.

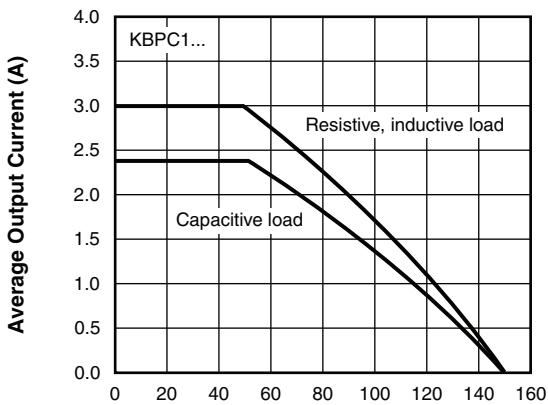

93585_01 Maximum Allowable Case Temperature (°C)

Fig. 1 - Case Temperature Ratings

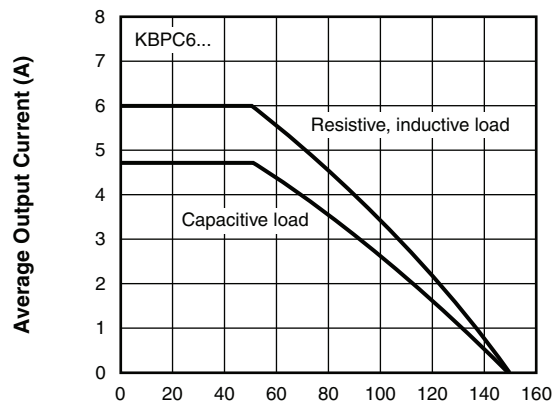

93585_02 Maximum Allowable Case Temperature (°C)

Fig. 2 - Case Temperature Ratings

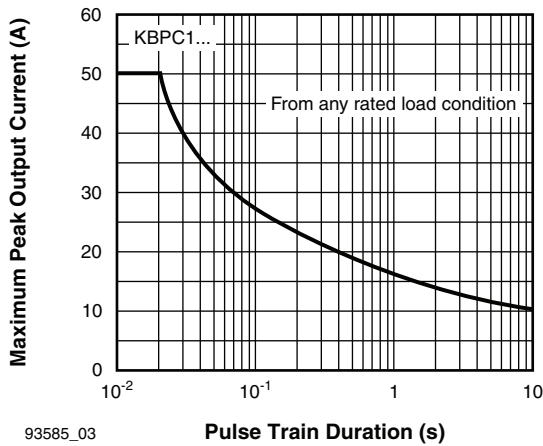

93585_03

Fig. 3 - Non-Repetitive Surge Ratings

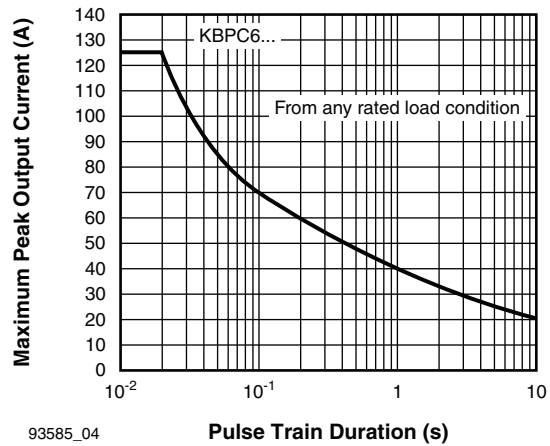

93585_04

Fig. 4 - Non-Repetitive Surge Ratings

CIRCUIT CONFIGURATION

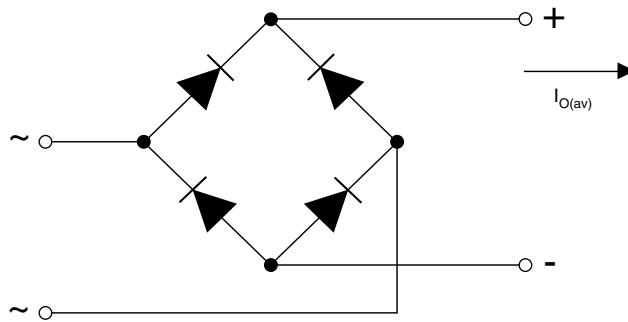

LINKS TO RELATED DOCUMENTS

Dimensions	www.vishay.com/doc?95250
------------	--



D-72

DIMENSIONS in millimeters (inches): **KBPC6, KBPC8**



DIMENSIONS in millimeters (inches): **KBPC1**

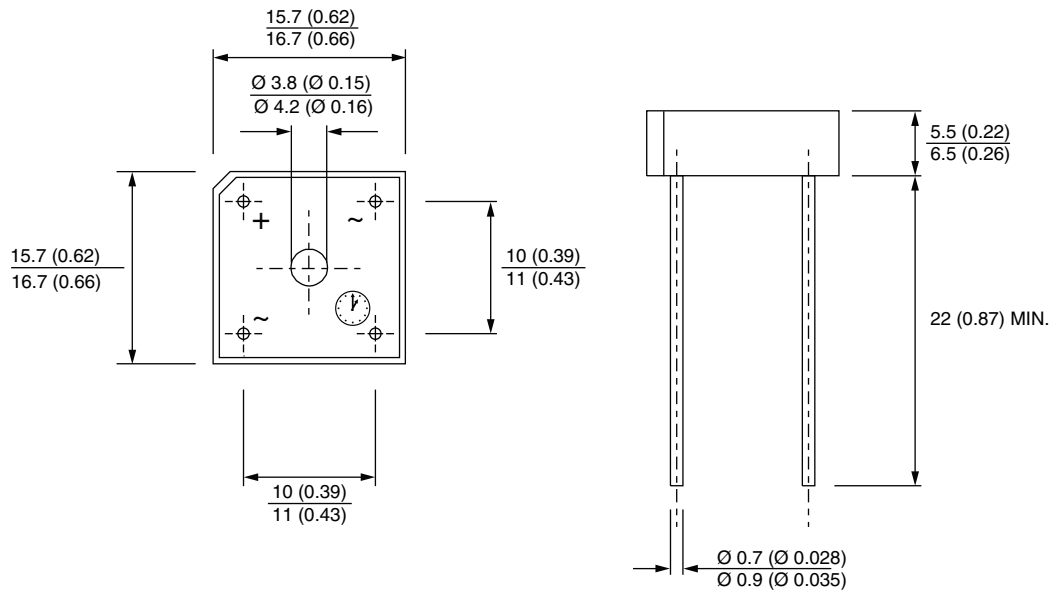



Disclaimer

ALL PRODUCT, PRODUCT SPECIFICATIONS AND DATA ARE SUBJECT TO CHANGE WITHOUT NOTICE TO IMPROVE RELIABILITY, FUNCTION OR DESIGN OR OTHERWISE.

Vishay Intertechnology, Inc., its affiliates, agents, and employees, and all persons acting on its or their behalf (collectively, "Vishay"), disclaim any and all liability for any errors, inaccuracies or incompleteness contained in any datasheet or in any other disclosure relating to any product.

Vishay makes no warranty, representation or guarantee regarding the suitability of the products for any particular purpose or the continuing production of any product. To the maximum extent permitted by applicable law, Vishay disclaims (i) any and all liability arising out of the application or use of any product, (ii) any and all liability, including without limitation special, consequential or incidental damages, and (iii) any and all implied warranties, including warranties of fitness for particular purpose, non-infringement and merchantability.

Statements regarding the suitability of products for certain types of applications are based on Vishay's knowledge of typical requirements that are often placed on Vishay products in generic applications. Such statements are not binding statements about the suitability of products for a particular application. It is the customer's responsibility to validate that a particular product with the properties described in the product specification is suitable for use in a particular application. Parameters provided in datasheets and / or specifications may vary in different applications and performance may vary over time. All operating parameters, including typical parameters, must be validated for each customer application by the customer's technical experts. Product specifications do not expand or otherwise modify Vishay's terms and conditions of purchase, including but not limited to the warranty expressed therein.

Except as expressly indicated in writing, Vishay products are not designed for use in medical, life-saving, or life-sustaining applications or for any other application in which the failure of the Vishay product could result in personal injury or death. Customers using or selling Vishay products not expressly indicated for use in such applications do so at their own risk. Please contact authorized Vishay personnel to obtain written terms and conditions regarding products designed for such applications.

No license, express or implied, by estoppel or otherwise, to any intellectual property rights is granted by this document or by any conduct of Vishay. Product names and markings noted herein may be trademarks of their respective owners.